

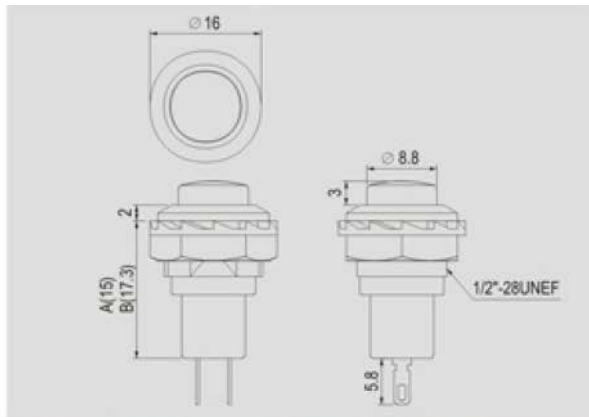

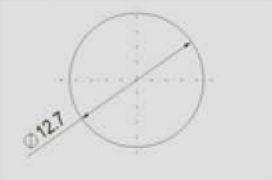

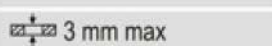

Push Switch



Rating
3A 125V AC 1.5A 250V AC
Contact resistance
50mΩ Max
Insulation resistance
DC 500V 100MΩ Min
Dielectric strength
AC 1000V 1 minute
Cut-out

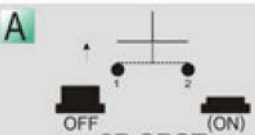

FEATURES

- * MATERIAL: Frames are nylon (UL flame: 94V-2). Terminals are silver plated brass.
- * M types are metal frames, nickel plated brass.
- * Mounted by nut.

BODY	FUNCTION	TERMINAL
P Plastic Body 	A  2P SPST OFF (ON)	0 5 SO
M Metal Body 	B  2P SPST (OFF) ON	0 5 SO
	C  3P SPDT (Only for R13-502MC) *() = momentary	

Unit: mm