

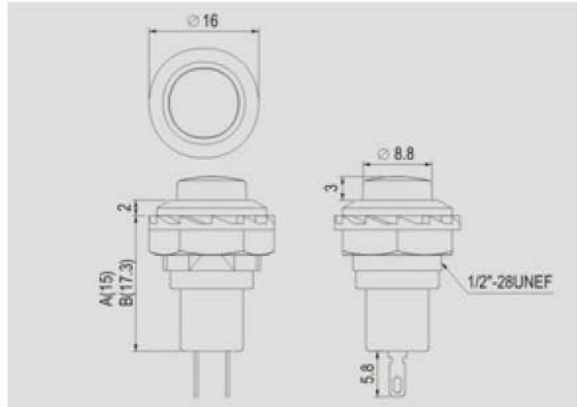

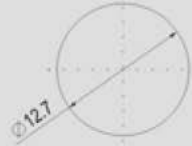

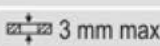

Push-Button Switch, Red



Rating
3A 125V AC 1.5A 250V AC
Contact resistance
50mΩ Max
Insulation resistance
DC 500V 100MΩ Min
Dielectric strength
AC 1000V 1 minute
Cut-out



FEATURES

- * MATERIAL: Frames are nylon (UL flame: 94V-2). Terminals are silver plated brass.
- * M types are metal frames, nickel plated brass.
- * Mounted by nut.

BODY	FUNCTION	TERMINAL
P Plastic Body 	A  OFF (ON) 2P SPST	0 5  SO
M Metal Body 	B  (OFF) ON 2P SPST	C  ON (ON) 3P SPDT (Only for R13-502MC) * () =momentary

Unit: mm