

Datasheet

Item no. 1587736

V1_0817_01_en

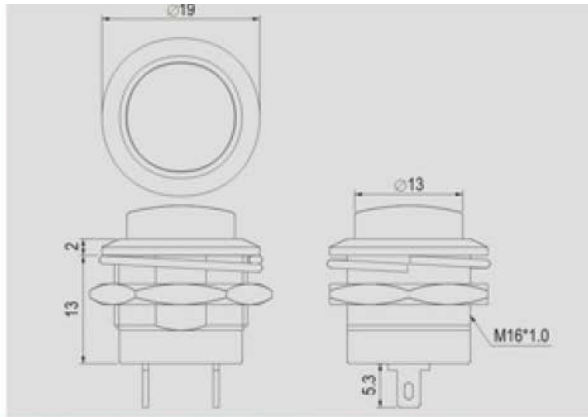

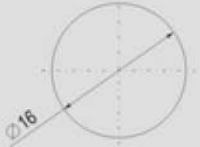
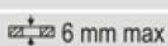

Push Switch



Rating
6A 125V AC 3A 250V AC
Contact resistance
50mΩ Max
Insulation resistance
DC 500V 100MΩ Min
Dielectric strength
AC 1000V 1 minute
Cut-out



FEATURES

- * MATERIAL: Frames are nylon (UL flame: 94V-2). Terminals are silver plated brass.
- * M type are metal frames, nickel plated brass.
- * Mounted by nut.

BODY		FUNCTION	TERMINAL
 Plastic Body	 Metal Body	 A OFF 2P SPST (ON)	0 5  SO
		* () = momentary	

Unit: mm