

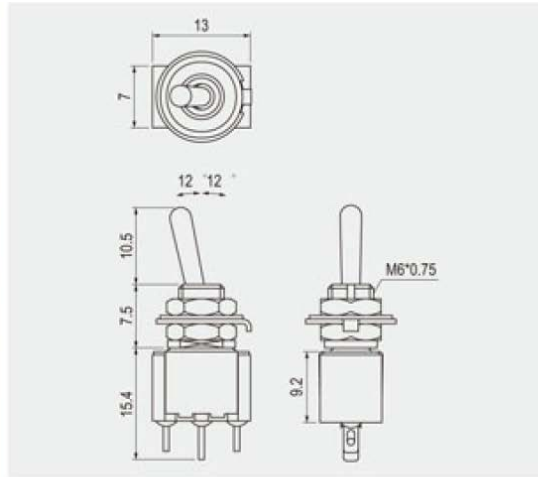

# Datasheet

Item no. 1587775

V1\_0817\_01\_en



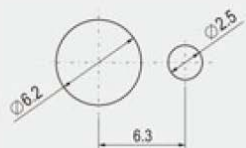





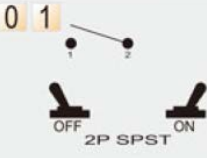
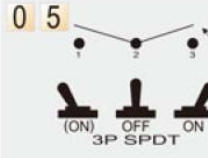

## Mini Switches

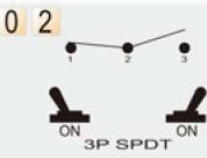
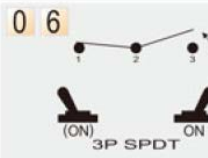

<b>Rating</b>
6A 125V AC 3A 250V AC
<b>Contact resistant</b>
50mΩ Max
<b>Insulation resistant</b>
DC 500V 100MΩ Min
<b>Dielectric strength</b>
AC 1000V 1 minute
<b>Cut out</b>

 1 mm max

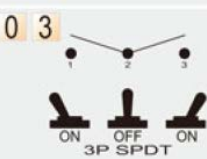
### FEATURES

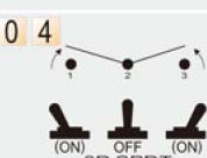
- \* MATERIAL: Phenolic base (UL flame: 94V-0).  
Contacts and Terminals are copper with silver alloy and silver plated.
- \* Epoxy sealed for dust and moisture resistant.
- \* Colorful handle covers and waterproof boot are optional for toggle type A.

FUNCTION		LEVER	TERMINAL
0 1  OFF 2P SPST ON	0 5  (ON) OFF ON 3P SPDT	A Standard  2.8 10.5	1  SO 2  PC 3  PC Angle(2.54) 5  PC Angle(3.8)
0 2  ON 3P SPDT ON	0 6  (ON) ON 3P SPDT	F Flat  5 12	
0 3  ON OFF ON 3P SPDT		G Plastic  5 15	
0 4  (ON) OFF (ON) 3P SPDT			

Unit: mm

This is a publication by Conrad Electronic SE, Klaus-Conrad-Str. 1, D-92240 Hirschau (www.conrad.com).

All rights including translation reserved. Reproduction by any method, e.g. photocopy, microfilming, or the capture in electronic data processing systems require the prior written approval by the editor. Reprinting, also in part, is prohibited. This publication represents the technical status at the time of printing.

© Copyright 2017 by Conrad Electronic SE.