

Datasheet

Item no. 1587778

V1_0817_01_en

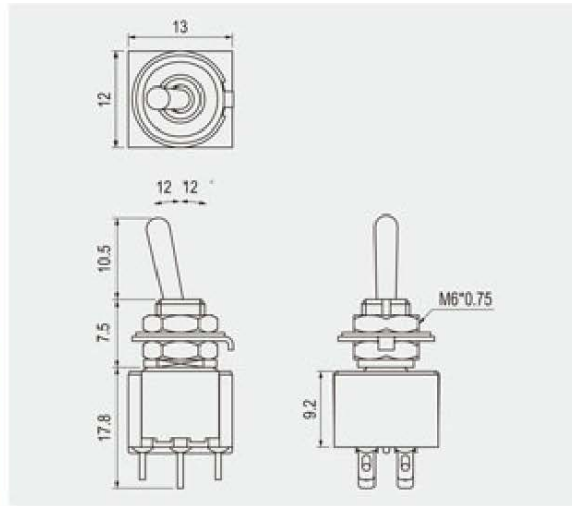



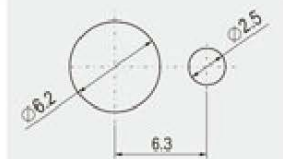
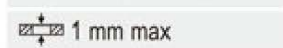

Mini Switch

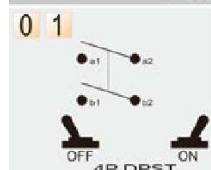
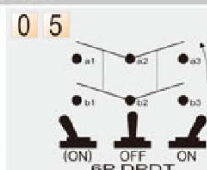

Rating
6A 125V AC 3A 250V AC
Contact resistant
50mΩ Max
Insulation resistant
DC 500V 100MΩ Min
Dielectric strength
AC 1000V 1 minute
Cut out

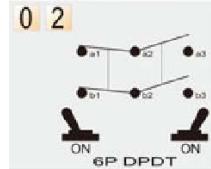
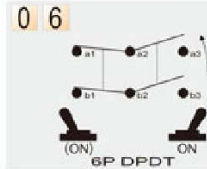

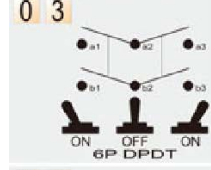
FEATURES

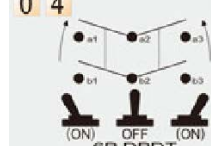
- * MATERIAL: Phenolic base (UL flame: 94V-0).
Contacts and Terminals are copper with silver alloy and silver plated.
- * Epoxy sealed for dust and moisture resistant.
- * Colorful handle covers and waterproof boot are optional for toggle type A.

FUNCTION		LEVER	TERMINAL
0 1  OFF 4P DPST ON	0 5  (ON) OFF ON 6P DPDT	A Standard 	1 SO 2 PC 3 PC Angle(2.54) 5 PC Angle(3.8)
0 2  ON 6P DPDT ON	0 6  (ON) 6P DPDT ON	F Flat 	
0 3  ON OFF ON 6P DPDT		G Plastic 	
0 4  (ON) OFF (ON) 6P DPDT			

Unit: mm

This is a publication by Conrad Electronic SE, Klaus-Conrad-Str. 1, D-92240 Hirschau (www.conrad.com).

All rights including translation reserved. Reproduction by any method, e.g. photocopy, microfilming, or the capture in electronic data processing systems require the prior written approval by the editor. Reprinting, also in part, is prohibited. This publication represents the technical status at the time of printing.

© Copyright 2017 by Conrad Electronic SE.

Mini Switch

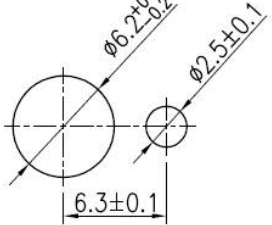
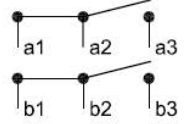
Rating	6A 125V AC 3A 250V AC		Mounting Hole		Circuit Diagram	
Contact Resistance	50m ohm Max.					
Insulation Resistance	DC 500V 100M ohm Min.					
Dielectric Strength	AC 1000V 1 minute					
Switch Function	6P DPDT ON-ON					

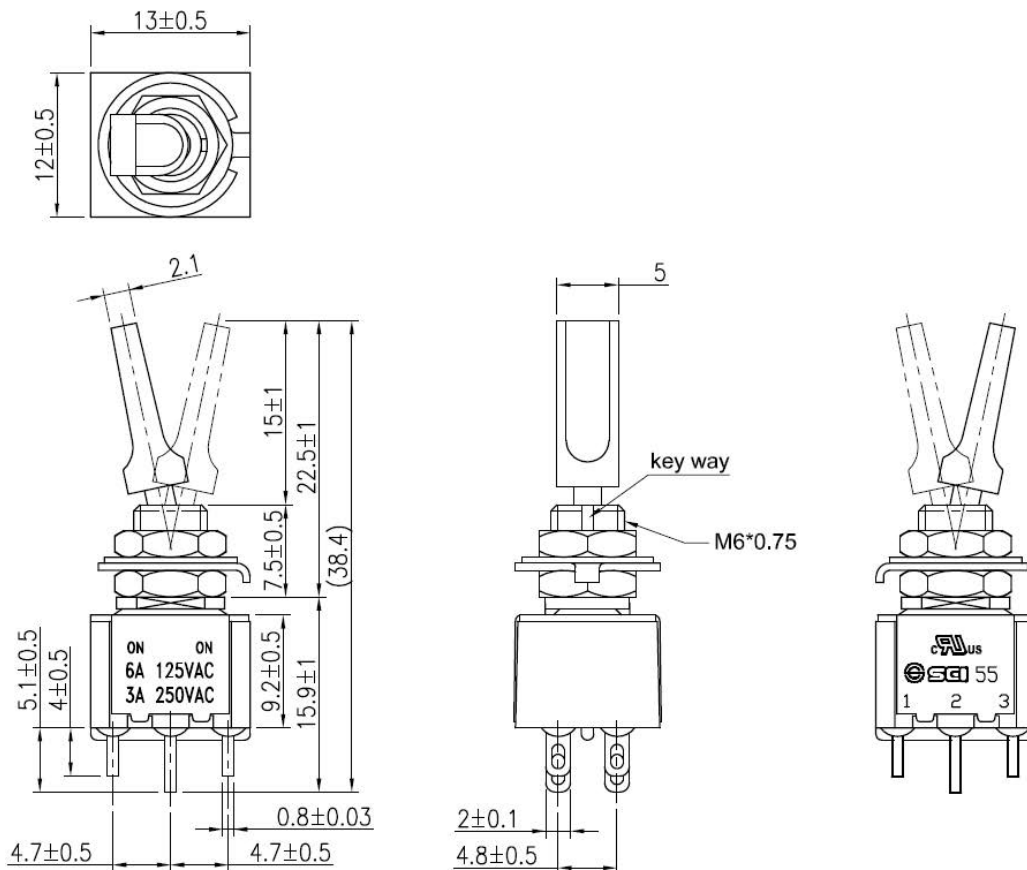

Tolerances Unless Otherwise Specified ±0.3 Unit: mm

This is a publication by Conrad Electronic SE, Klaus-Conrad-Str. 1, D-92240 Hirschau (www.conrad.com).

All rights including translation reserved. Reproduction by any method, e.g. photocopy, microfilming, or the capture in electronic data processing systems require the prior written approval by the editor. Reprinting, also in part, is prohibited. This publication represents the technical status at the time of printing.

© Copyright 2017 by Conrad Electronic SE.