

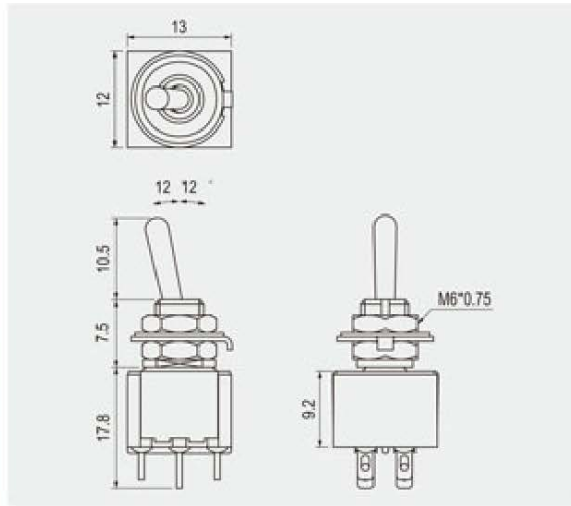

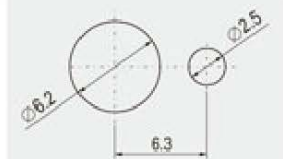

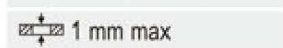



Mini Switch, BLUE LEVER

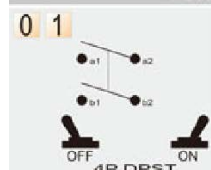
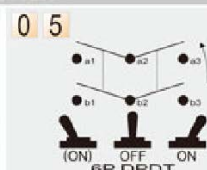

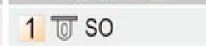
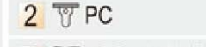
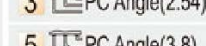
Rating
6A 125V AC 3A 250V AC
Contact resistant
50mΩ Max
Insulation resistant
DC 500V 100MΩ Min
Dielectric strength
AC 1000V 1 minute
Cut out

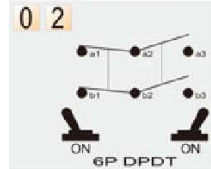
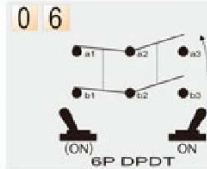

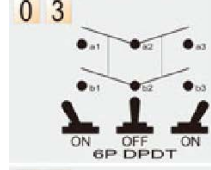
FEATURES

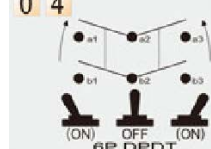
- * MATERIAL: Phenolic base (UL flame: 94V-0).
Contacts and Terminals are copper with silver alloy and silver plated.
- * Epoxy sealed for dust and moisture resistant.
- * Colorful handle covers and waterproof boot are optional for toggle type A.

FUNCTION		LEVER	TERMINAL
<p>0 1</p>  <p>4P DPST</p>	<p>0 5</p>  <p>6P DPDT</p>	<p>A Standard</p> 	<p>1  SO</p> <p>2  PC</p> <p>3  PC Angle(2.54)</p> <p>5  PC Angle(3.8)</p>
<p>0 2</p>  <p>6P DPDT</p>	<p>0 6</p>  <p>6P DPDT</p>	<p>F Flat</p> 	
<p>0 3</p>  <p>6P DPDT</p>		<p>G Plastic</p> 	
<p>0 4</p>  <p>6P DPDT</p>			

Unit: mm

This is a publication by Conrad Electronic SE, Klaus-Conrad-Str. 1, D-92240 Hirschau (www.conrad.com).

All rights including translation reserved. Reproduction by any method, e.g. photocopy, microfilming, or the capture in electronic data processing systems require the prior written approval by the editor. Reprinting, also in part, is prohibited. This publication represents the technical status at the time of printing.

© Copyright 2017 by Conrad Electronic SE.

Mini Switch, BLUE LEVER

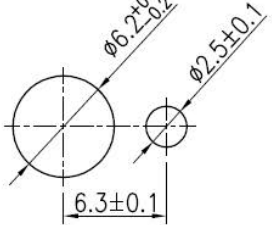
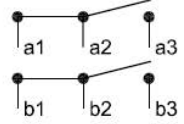
Rating	6A 125V AC 3A 250V AC		Mounting Hole	Circuit Diagram
Contact Resistance	50m ohm Max.			
Insulation Resistance	DC 500V 100M ohm Min.			
Dielectric Strength	AC 1000V 1 minute			
Switch Function	6P DPDT ON-ON			

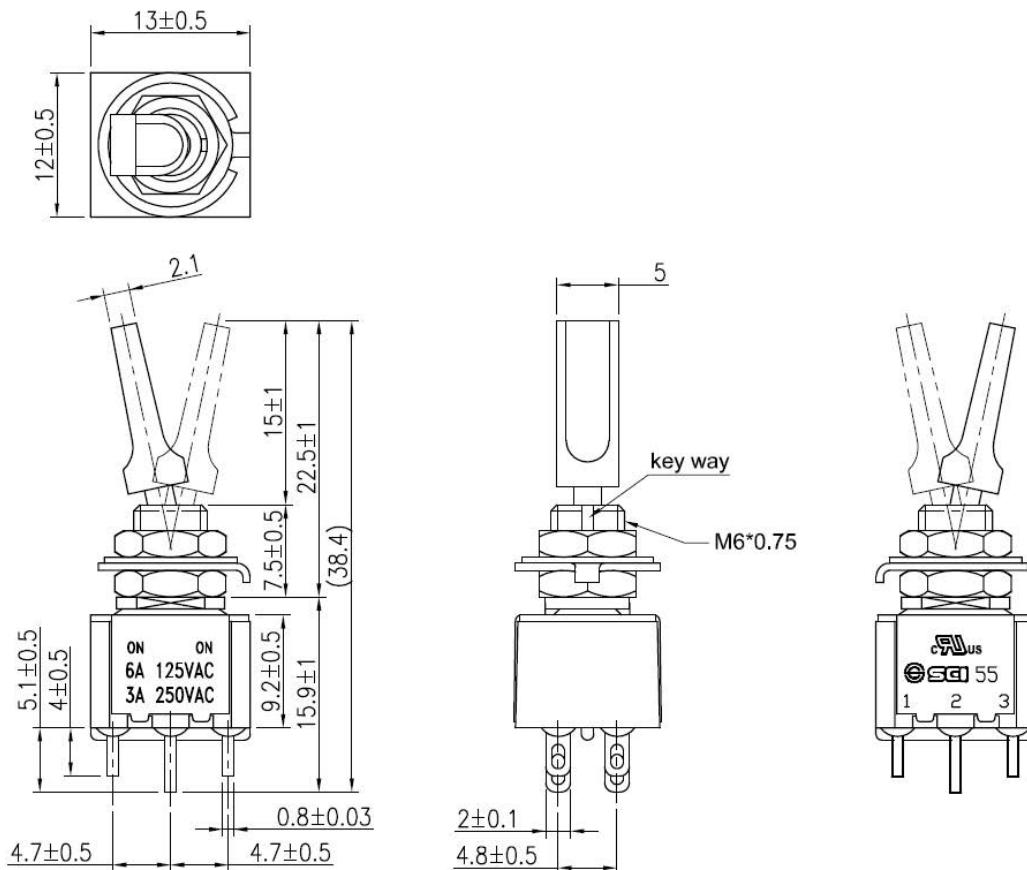

Tolerances Unless Otherwise Specified ± 0.3 Unit: mm

This is a publication by Conrad Electronic SE, Klaus-Conrad-Str. 1, D-92240 Hirschau (www.conrad.com).

All rights including translation reserved. Reproduction by any method, e.g. photocopy, microfilming, or the capture in electronic data processing systems require the prior written approval by the editor. Reprinting, also in part, is prohibited. This publication represents the technical status at the time of printing.

© Copyright 2017 by Conrad Electronic SE.