

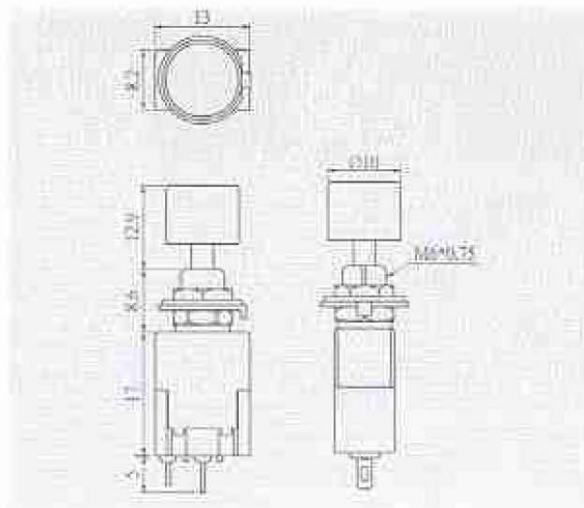







## Mini Push-Button Switches, Red



<b>Rating</b>	6A 125V AC 3A 250V AC
<b>Contact resistance</b>	50mΩ Max
<b>Insulation resistant</b>	DC 500V 100MΩ Min
<b>Dielectric strength</b>	AC 1000V 1 minute
<b>Cut-out</b>	
	 4 mm max

### FEATURES

- \* MATERIAL: Alkyd base (UL flame: 94V-0) for high insulation. Stainless steel cover for high corrosion resistant.
- \* Contacts and Terminals are copper with silver alloy and silver plated.
- \* Epoxy sealed for dust and moisture resistant.

FUNCTION	BUTTON	TERMINAL
<p>0 1</p>  <p>ON OFF</p> <p>2P-SPST</p>	<p>A</p> 	<p>1  SO</p> <p>2  PC</p> <p>3  PC Angle(2.54)</p> <p>5  PC Angle(3.8)</p>
<p>0 2</p>  <p>ON ON</p> <p>3P-SPDT</p>		
<p>0 6</p>  <p>ON ON</p> <p>3P-SPDT</p>		

Fireproof: 94V-0  
Protection Class: IP30

Unit: mm