

Toggle Switch, 3P SPDT ON-ON, 15A125VAC/10A250VAC, Screw terminals

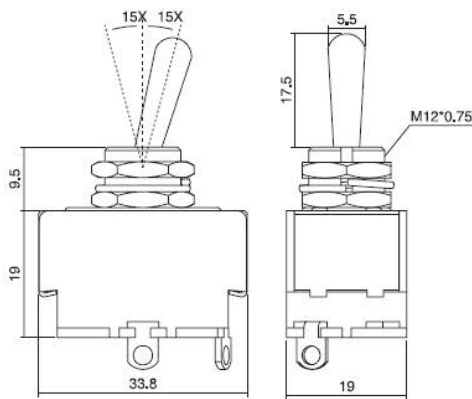

70 10 24-12

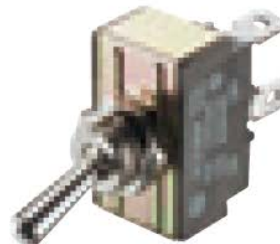

70 11 92-12



70 10 29-12

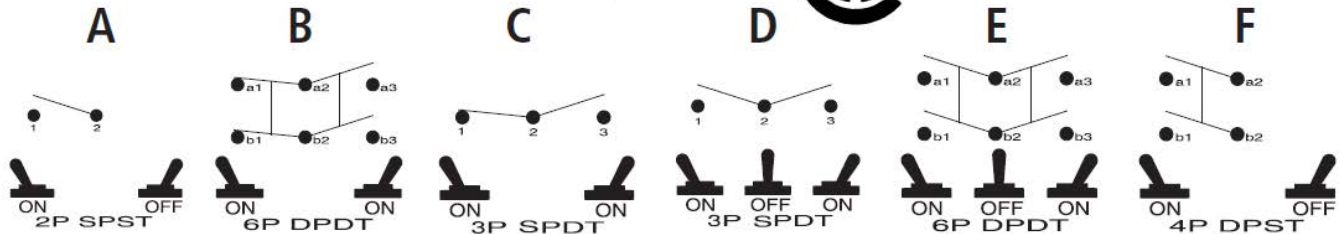

Kippschalter mit Rahmen aus Nylon ·
Anschlüsse Messing vernickelt · Phenol-
harz Grundplatte · Mit Führungsnut für
Frontplatteneinbau.

Technische Daten: Schaltleistung
125 V/AC 15 A, 250 V/AC 10 A · Kontakt-

widerstand 50 mΩ max. · Isolations-
widerstand DC 500 V 100 MΩ min. ·
Spannungsfestigkeit AC 1500 V/60 s ·
Einbau-Ø 12,2 · Max. Frontplattenstärke
4 mm.

Unit: mm

Toggle Switch, 3P SPDT ON-ON, 15A125VAC/10A250VAC, quick terminals

Best.-Nr.	Hersteller-bez.	Typ	Ausf.	Anschluss
70 11 92-12	R13-28A-01	1pol.	EIN/AUS	Flachstecker
70 10 23-12	R13-28B-01	2pol.	EIN/EIN	Flachstecker
70 12 12-12 NEU!	R13-28C-01	1pol.	EIN/EIN	Flachstecker
70 12 14-12 NEU!	R13-28D-01	1pol.	EIN/AUS/EIN	Flachstecker
70 10 24-12	R13-28E-01	2pol.	EIN/AUS/EIN	Flachstecker
70 10 26-12	R13-28F-01	2pol.	EIN/AUS	Flachstecker
70 11 93-12	R13-28A-06	1pol.	EIN/AUS	Schraubanschl.
70 10 27-12	R13-28B-06	2pol.	EIN/EIN	Schraubanschl.
70 12 13-12 NEU!	R13-28C-06	1pol.	EIN/EIN	Schraubanschl.
70 12 15-12 NEU!	R13-28D-06	1pol.	EIN/AUS/EIN	Schraubanschl.
70 10 28-12	R13-28E-06	2pol.	EIN/AUS/EIN	Schraubanschl.
70 10 29-12	R13-28F-06	2pol.	EIN/AUS	Schraubanschl.

Unit: mm

This is a publication by Conrad Electronic SE, Klaus-Conrad-Str. 1, D-92240 Hirschau (www.conrad.com).

All rights including translation reserved. Reproduction by any method, e.g. photocopy, microfilming, or the capture in electronic data processing systems require the prior written approval by the editor. Reprinting, also in part, is prohibited. This publication represents the technical status at the time of printing.

© Copyright 2017 by Conrad Electronic SE.



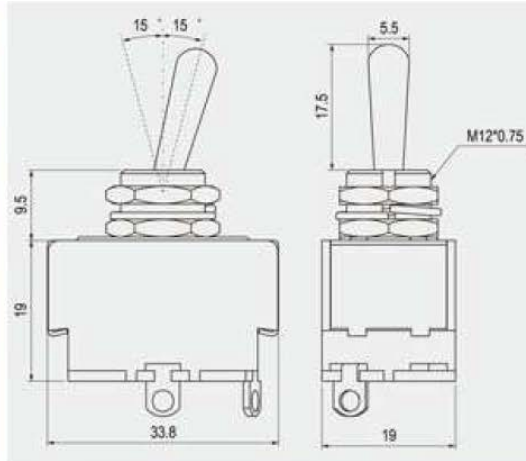

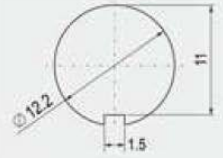



Toggle Switch, 3P SPDT ON-ON, 15A125VAC/10A250VAC, quick terminals

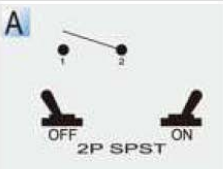
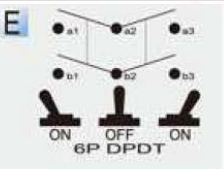
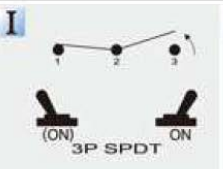
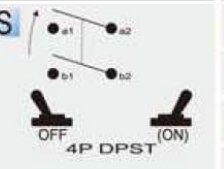

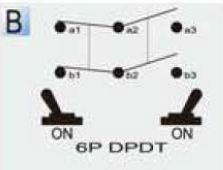
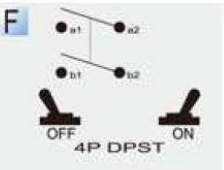
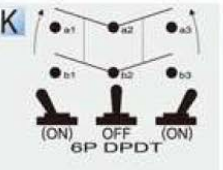
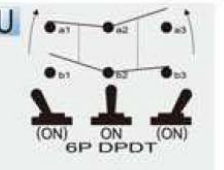
Rating	15A 125V AC 10A 250V AC
Contact resistance	50mΩ Max
Insulation resistance	DC 500V 100MΩ Min
Dielectric strength	AC 1500V 1 minute
Cut-out	 4 mm max

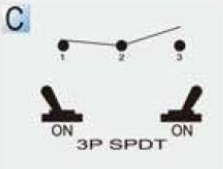
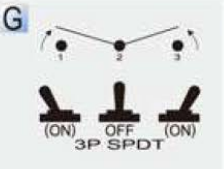
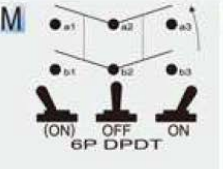
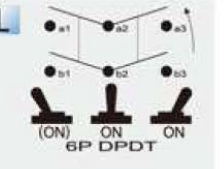
FEATURES

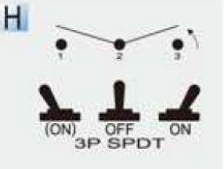
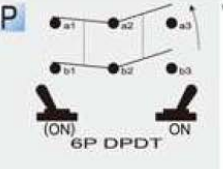
- * MATERIAL: Metal lever and bushing are nickel plated metal. Frame is metal plated steel. Terminals are nickel plated brass. Base is phenolic.
- * Standard toggle lever.
- * Indicator plate, waterproof boot, safety cover and connector are optional.

FUNCTION				TERMINAL
A  2P SPST	E  6P DPDT	I  3P SPDT	S  4P DPST	0 1  .250" SQ
B  6P DPDT	F  4P DPST	K  6P DPDT	U  6P DPDT	0 5  SO
C  3P SPDT	G  3P SPDT	M  6P DPDT	L  6P DPDT	0 6  SC 3
D  3P SPDT	H  3P SPDT	P  6P DPDT		0 7  SC 4

* () = momentary

Unit: mm

This is a publication by Conrad Electronic SE, Klaus-Conrad-Str. 1, D-92240 Hirschau (www.conrad.com).

All rights including translation reserved. Reproduction by any method, e.g. photocopy, microfilming, or the capture in electronic data processing systems require the prior written approval by the editor. Reprinting, also in part, is prohibited. This publication represents the technical status at the time of printing.

© Copyright 2017 by Conrad Electronic SE.