

Datasheet

Item no. 1587870

V1_0817_01_en

Push Switch, Yellow

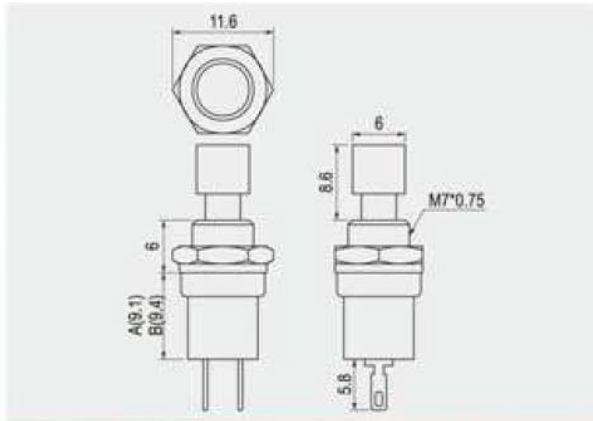



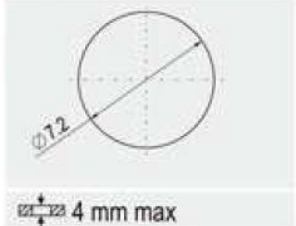

Rating
3A 125V AC 1.5A 250V AC
Contact resistance
50mΩ Max
Insulation resistance
DC 500V 100MΩ Min
Dielectric strength
AC 1000V 1 minute
Cut-out

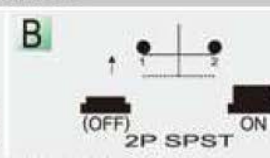

FEATURES

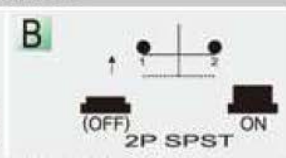
- * MATERIAL: Actuator is PBT (UL Frames: 94V-0). Frame is nickel plated metal. Base is PBT (HB).
- * Actuator's size is optional.
- * Mounted by nut.

FUNCTION		BUTTON	TERMINAL
A			0 5  SO
B			

* () =momentary

Unit: mm