

# Datasheet

Item no. 1587882

V1\_0817\_01\_en

## Push Switch, Blue

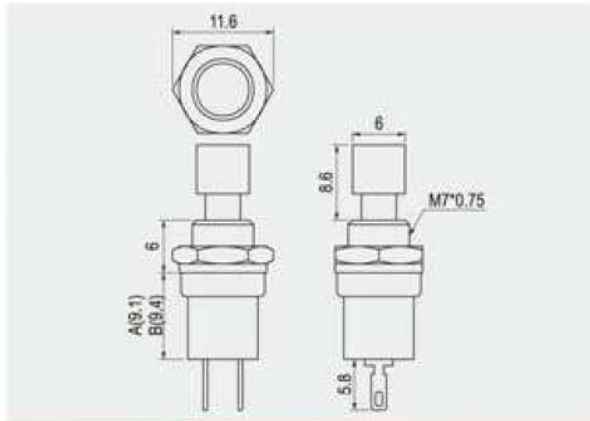



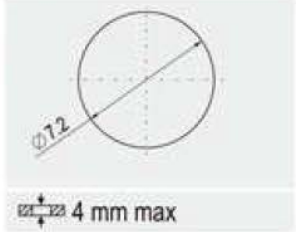

<b>Rating</b>
3A 125V AC 1.5A 250V AC
<b>Contact resistance</b>
50mΩ Max
<b>Insulation resistance</b>
DC 500V 100MΩ Min
<b>Dielectric strength</b>
AC 1000V 1 minute
<b>Cut-out</b>

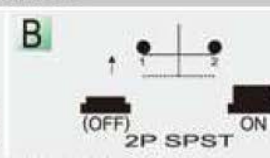

### FEATURES

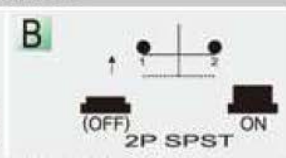
- \* MATERIAL: Actuator is PBT ( UL Frames: 94V-0). Frame is nickel plated metal. Base is PBT (HB).
- \* Actuator's size is optional.
- \* Mounted by nut.

FUNCTION		BUTTON	TERMINAL
<b>A</b>  2P SPST	<b>B</b>  2P SPST * ( ) =momentary	 	0 5  SO

Unit: mm