



Getting Started

When using the unit for the first time, make sure to connect the unit to a wall outlet using the AC adaptor (supplied). Otherwise, the unit will not turn on.

1 Connect the unit to a wall outlet and charge the unit.

The built-in battery will be fully charged (100%) in up to 6 hours.

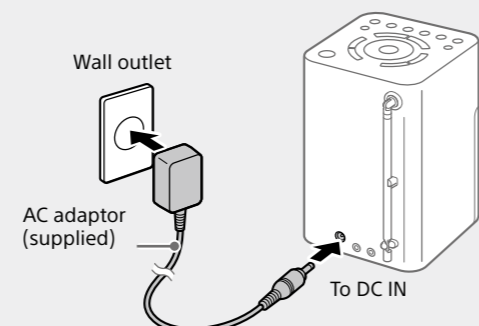

2 Extend the antenna.

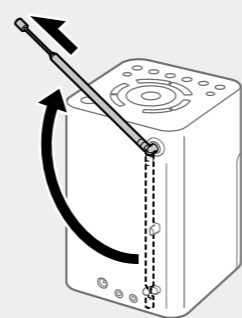

3 Turn on the unit.

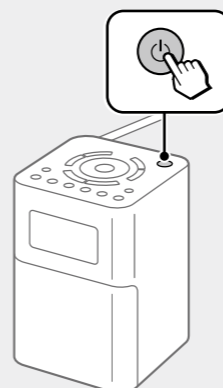

When turning on the unit for the first time
DAB auto tune will start automatically when the unit is turned on for the first time. After DAB auto tune is completed, the unit receives the first station in the DAB station list stored by DAB auto tune. If you want to cancel DAB auto tune process, press **BACK**.

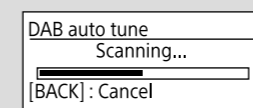

To cancel the auto tune process while in progress, press **BACK**.

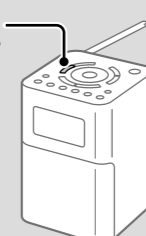

Tip
To perform auto tune again later, see "To make a new DAB/FM station list" below.

To turn off the unit

Setting the unit to standby mode



The unit switches to standby mode and the clock appears on the display.

Turning off the power completely (Off mode)



Press and hold **POWER** for about 2 seconds.

Power to the unit is shut off and the display goes blank. Set the unit to off mode when you are not using it to save power.

Listening to the Radio

See "Setting Menu Options" for manual tuning.

1 Turn on the unit.

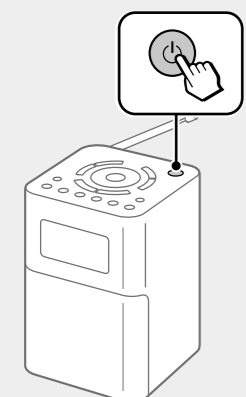

2 Select the "DAB" or "FM" function.

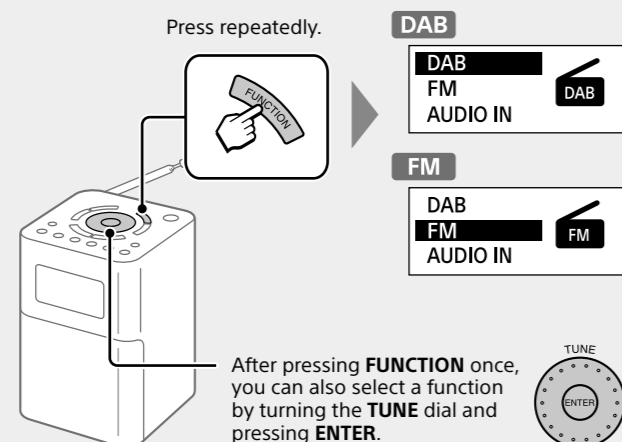

The unit automatically switches to the selected function after about 2 seconds.

After pressing **FUNCTION** once, you can also select a function by turning the **TUNE** dial and pressing **ENTER**.

When selecting the FM function for the first time

FM auto tune will start automatically when the FM function is selected for the first time.

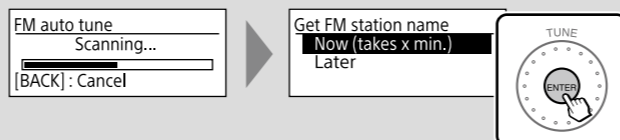

Tips

- Even if you select "Later" on the "Get FM station name" screen, FM station names will be received and stored in the unit while you are listening to broadcasts.
- FM station names may not be transmitted, depending on the station.

3 Select the desired station or service.

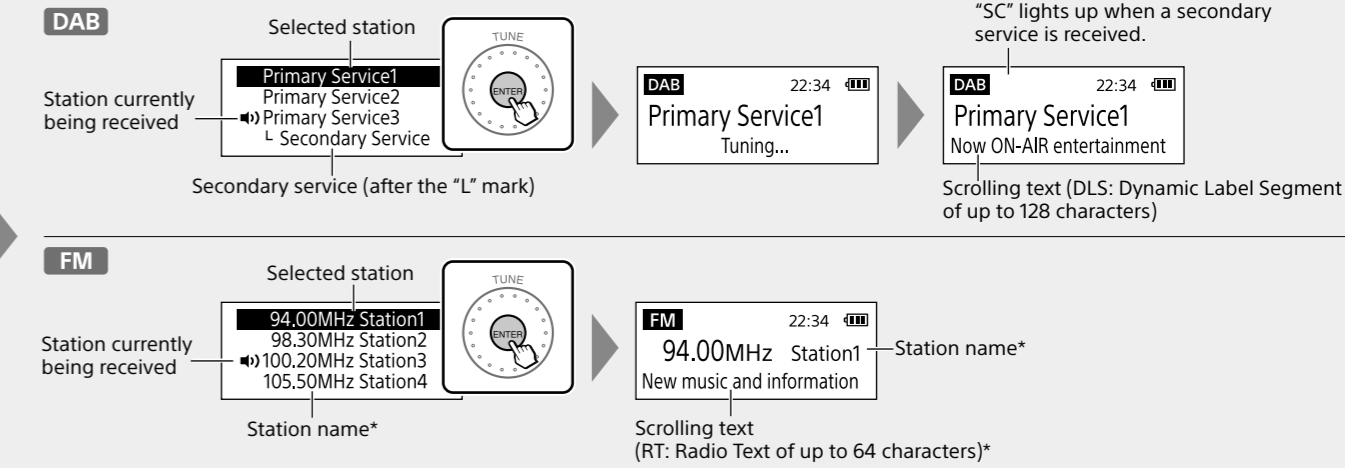
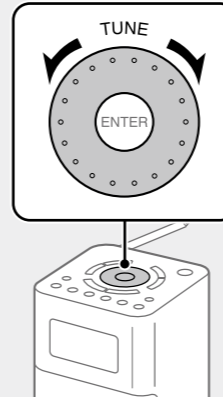

Presetting stations (5 DAB and 5 FM)

1 Tune to the station you want to preset.

Follow the steps in "Listening to the Radio" above.



2 Press and hold the desired preset button (1-5) until "Stored to [PRESET x]." appears on the display.

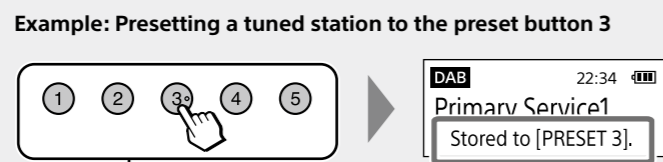

Example: Presetting a tuned station to the preset button 3

Tips

- If you try to store another station with the same preset number, the previously stored station will be replaced.
- The preset stations remain in the unit's memory even after an auto tune is performed.
- The preset button 3 on the unit has a tactile dot. Use the tactile dot as a reference when operating the unit.

Listening to a preset station

1 Select the "DAB" or "FM" function.



2 Select the desired preset station.

Example: When the preset button 3 is pressed



Note

To avoid changing the preset accidentally, do not hold down the preset button.

About the FM auto tune process

You can cancel the FM auto tune process that starts after the FM function is selected for the first time. However, if you want to tune to stations by station list, you will need to perform FM auto tune. For details on how to perform FM auto tune later, see "To make a new DAB/FM station list."

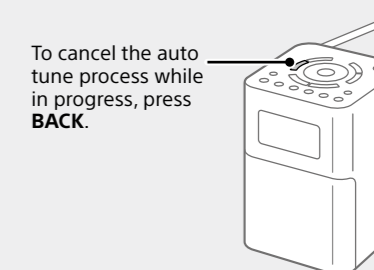

To adjust the volume

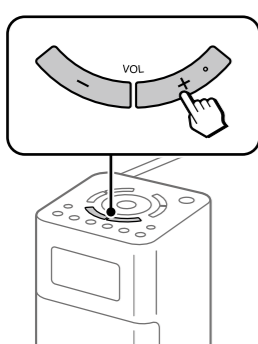

- The last set volume is stored in the unit's memory.
- **VOL +** on the unit has a tactile dot. Use the tactile dot as a reference when operating the unit.

To improve DAB/FM radio reception

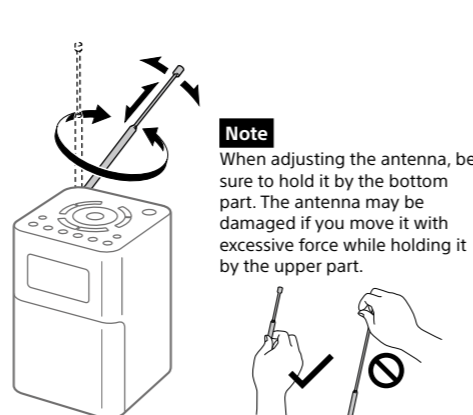
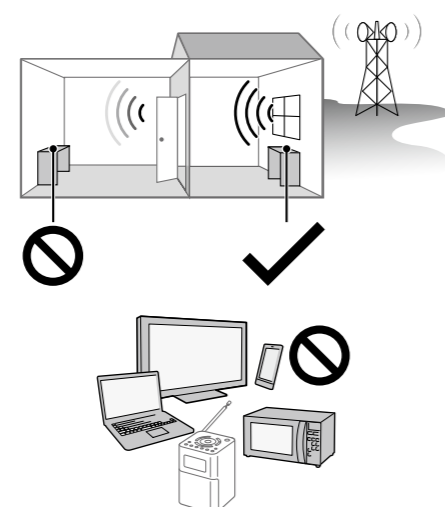

Note
When adjusting the antenna, be sure to hold it by the bottom part. The antenna may be damaged if you move it with excessive force while holding it by the upper part.

To make a new DAB/FM station list

If you have moved to another region, perform DAB and FM auto tunes again. Select the "DAB" or "FM" function, then press **AUTO TUNE**.

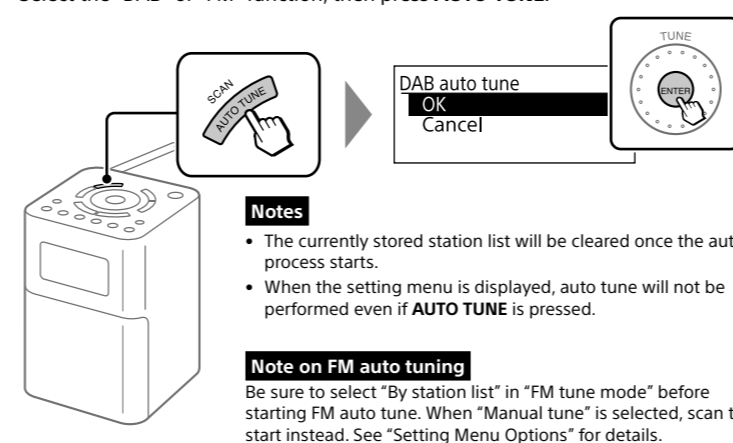

Notes

- The currently stored station list will be cleared once the auto tune process starts.
- When the setting menu is displayed, auto tune will not be performed even if **AUTO TUNE** is pressed.

Note on FM auto tuning

Be sure to select "By station list" in "FM tune mode" before starting FM auto tune. When "Manual tune" is selected, scan tuning will start instead. See "Setting Menu Options" for details.

Listening to Music from an External Device

1 Connect the external device to the unit.

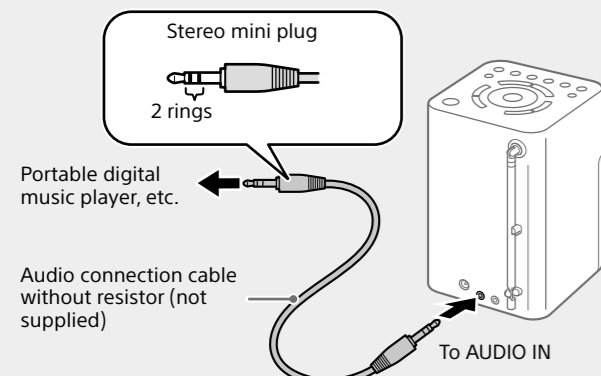

2 Turn on the unit.

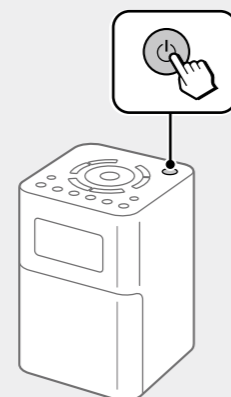

3 Select the "AUDIO IN" function.

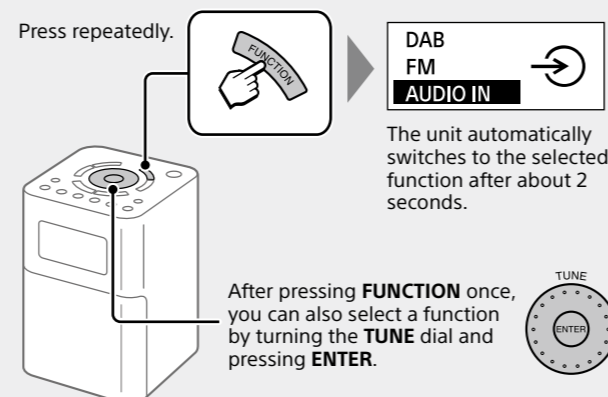

The unit automatically switches to the selected function after about 2 seconds.

After pressing **FUNCTION** once, you can also select a function by turning the **TUNE** dial and pressing **ENTER**.

4 Start playback on the connected device.

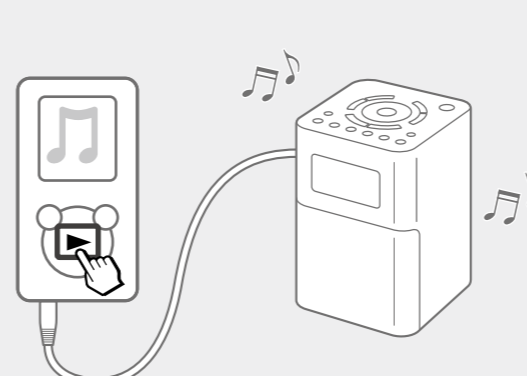

To adjust the volume

Select the appropriate volume on the connected device and then adjust it on the unit using **VOL +** or **-** buttons.

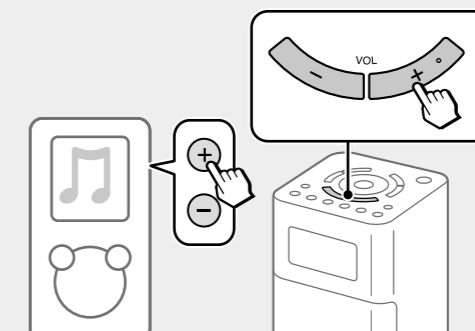

Setting the Wake-up Timer

1 Set a time for the wake-up timer.

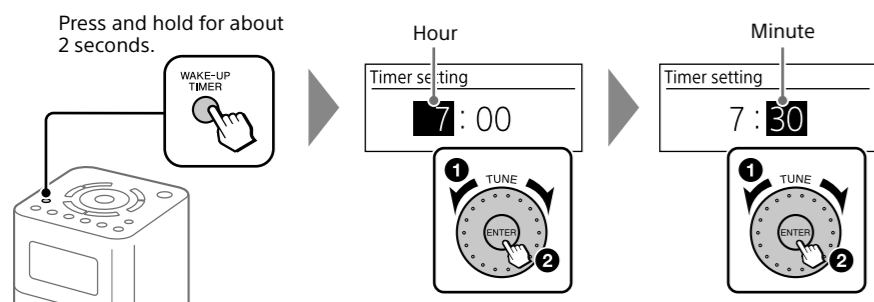

Tip
You can also set the wake-up timer from the setting menu. See "Setting Menu Options" for details.

2 Set the station to receive at the set time.

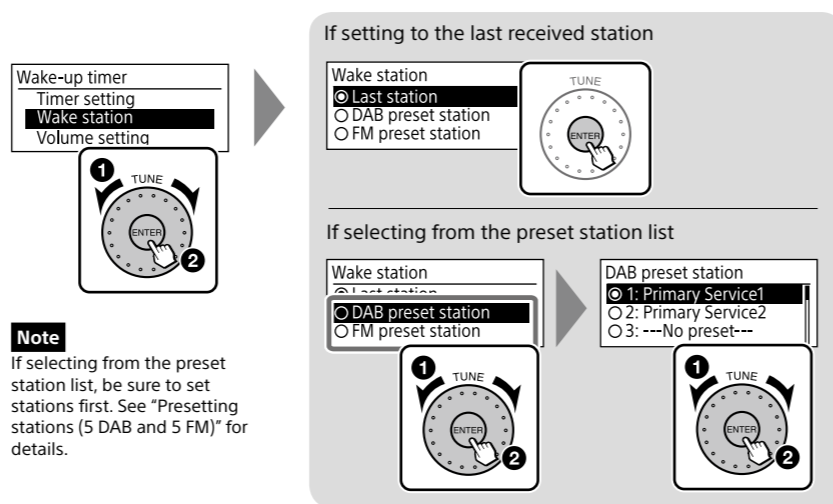

Note
If selecting from the preset station list, be sure to set stations first. See "Presetting stations (5 DAB and 5 FM)" for details.

Press **BACK** until the display returns to the "Wake-up timer" menu.

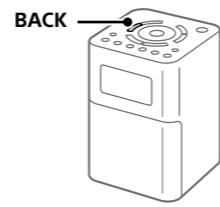

3 Adjust the volume.

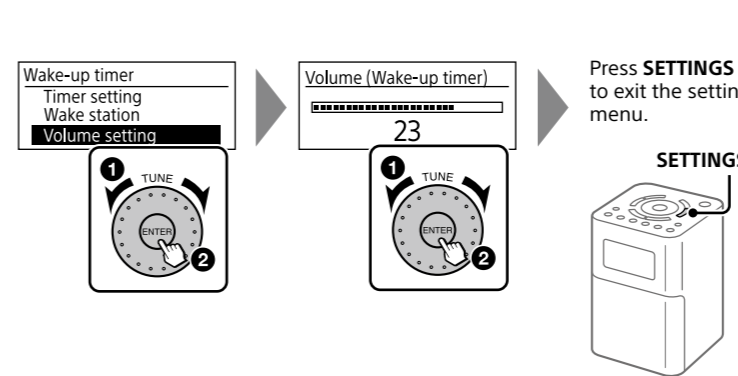

Press **SETTINGS** to exit the setting menu.



4 Activate the timer.

Do not hold down the button, or the display will switch to the "Timer setting" menu.

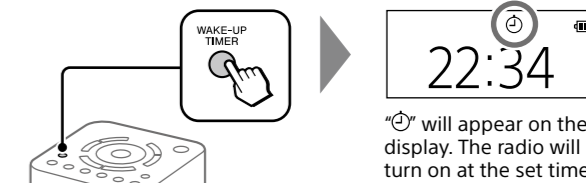

⏰ will appear on the display. The radio will turn on at the set time.

To deactivate the timer
Press **WAKE-UP TIMER** again.

Note
The wake-up timer function is disabled in off mode.

Setting the Sleep Timer

Press **SLEEP TIMER** repeatedly to select the desired time (in minutes).

90 → 60 → 30 → 15
OFF

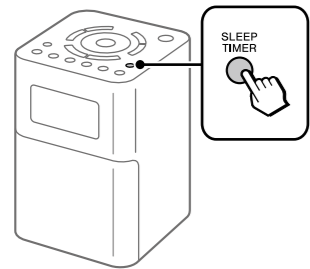

When the sleep timer is set, "SLEEP" appears on the display. The unit enters standby mode automatically after a set time has elapsed.

Tips

- The last set time is stored in the unit's memory.
- You can check the time left until the unit enters standby mode by pressing **SLEEP TIMER** again after setting the sleep timer.

Setting the Brightness of the Display

Press **☀** repeatedly to select the desired brightness.

High (default) → Middle → Low
Off

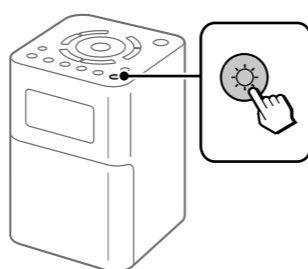

Note
When the unit is powered by the built-in battery, the backlighting of the display turns off about half a minute after the last operation.

Listening through Headphones

Connect headphones that have a stereo or monaural mini plug (not supplied).

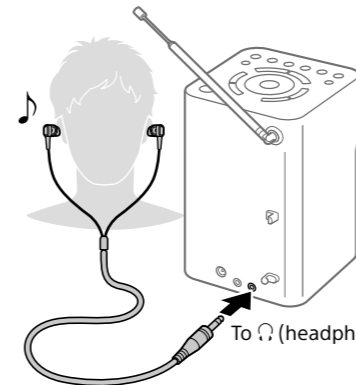

Notes

- To protect your hearing, avoid excessive volume levels when listening through headphones.
- Use headphones with a stereo (3-pole) or monaural (2-pole) mini plug. If you use headphones with another type of plug, there may be noise interference or no sound may be heard.

Compatible plug types

- 1 ring: Monaural* mini plug
- 2 rings: Stereo mini plug

Other types of plugs cannot be used.

- 3 or more rings

* When listening to stereo sound through monaural headphones, you will hear sound from the left channel only.

Setting Menu Options

Basic Operations:

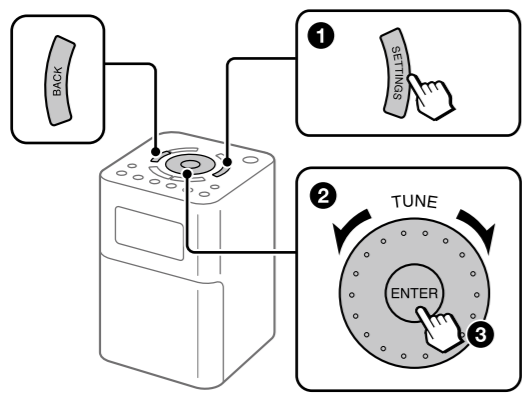

To go back to the upper menu level
Press **BACK**.

To exit the setting menu
Press **SETTINGS** again.

Radio options

Radio options can be set when the "DAB" or "FM" function is selected.

Information **DAB**

Displays various information for the station to which you are listening.

Channel: Channel and frequency (See the DAB frequency table in "Specifications.")

Multiplex name: Ensemble label (up to 16 characters long)

Service name: Station name

PTY: PTY label (See "PTY (programme type)" in "Specifications.")

Bit rate: Bit rate

Signal level: Displays the signal level for the DAB station to which you are listening, ranging from 0 (no signal) to 100 (maximum signal).

Note

If there is no ensemble label or station name, the space for the label or name will be blank. If there is no PTY label, "No PTY" will appear on the display.

DAB manual tune **DAB**

If DAB reception by DAB auto tune is poor, try manual tuning.

Turn the **TUNE** dial to select the desired DAB channel and then press **ENTER**.

DAB manual tune	
5A	174.928MHz
5B	176.640MHz
5C	178.352MHz

The radio starts scanning for receivable stations in the selected channel.

Tip

The new station received by manual tuning is stored in the DAB station list.

FM tune mode **FM**

Select the tuning mode for FM.

By station list: You can select the desired station from the list of FM stations stored by auto tune.

Manual tune: You can manually tune to the desired FM frequency in 0.05 MHz steps. Turn the **TUNE** dial to select the frequency.

Scan tuning in "Manual tune" mode
Press **AUTO TUNE (SCAN)** to start scanning FM stations.

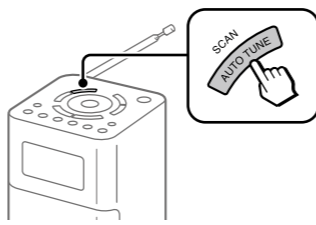

If a receivable station is found, "[ENTER]:Select" will appear on the display. Press **ENTER** to receive the station. (If you do not press **ENTER** within 3 seconds, the search will restart.)

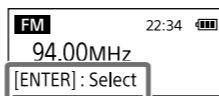

Tips

- To change the scanning direction, turn the **TUNE** dial clockwise or counterclockwise.
- Press **BACK** to stop scanning FM stations.

Edit FM station list **FM**

You can edit the FM station list.

Get FM station name: Perform this operation when you want to receive RDS information such as station names. Select "OK" to start scanning for RDS data.

Notes

- Set "FM tune mode" to "By station list" before you perform this operation.
- The currently stored RDS information will be cleared once scanning starts.
- It may take a long time to receive all the available RDS data.

Delete FM station: You can delete any unwanted stations from the FM station list.

- Turn the **TUNE** dial to select the station you want to delete, and then press **ENTER**.
- Turn the **TUNE** dial to select "OK," and then press **ENTER**.

Add FM station: When listening to a manually tuned station, you can add the station to the FM station list. Select "OK" to add the station to the list. Be sure to set "FM tune mode" to "Manual tune" before using this option.

Specifications

Operating temperature range

5°C – 35°C

Time display

24-hour system or 12-hour system

Frequency range

DAB (Band-III): 174.928 MHz – 239.200 MHz
FM: 87.5 MHz – 108 MHz
(0.05 MHz step)

Intermediate frequency

DAB (Band-III): 1,750 kHz
FM: 350 kHz

DAB (Band-III) frequency table (MHz)

Channel	Frequency	Channel	Frequency
5A	174.928	10A	209.936
5B	176.640	10B	211.648
5C	178.352	10C	213.360
5D	180.064	10D	215.072
6A	181.936	11A	216.928
6B	183.848	11B	218.840
6C	185.360	11C	220.352
6D	187.072	11D	222.064
7A	188.928	12A	223.936
7B	190.640	12B	225.648
7C	192.352	12C	227.360
7D	194.064	12D	229.072
8A	195.936	13A	230.784
8B	197.848	13B	232.496
8C	199.360	13C	234.208
8D	201.072	13D	235.776
9A	202.928	13E	237.488
9B	204.640	13F	239.200
9C	206.352		
9D	208.064		

Speaker

Approx. 45 mm dia., 4 Ω, stereo

Audio power output

2.5 W + 2.5 W (when the unit is powered by the supplied AC adaptor)
1.5 W + 1.5 W (when the unit is powered by the built-in battery)

Other options

Wake-up timer

Timer setting: Set a time for the wake-up timer.

Wake station: Select the station you want to receive at the set time.

Volume setting: Adjust the volume for the timer.

Also see "Setting the Wake-up Timer."

Sound

You can adjust the sound level.

Treble: Adjusts the level of high-pitched sound.

Bass: Adjusts the level of low-pitched sound.

Time

Set time: "Auto (DAB)" is set by default. This enables the clock to synchronize with the DAB data being received. Select "Time setting" to set the clock manually.

12H/24H: Select the clock display mode, 12-hour clock or 24-hour clock.

Note

The clock will be reset if the AC adaptor is unplugged and the built-in battery is completely exhausted.

Beep

Select "On" to activate the beep sound when you operate the unit.

Auto power off

When "Auto power off" is set to "Enable (15min)," the unit enters standby mode automatically after about 15 minutes if there is no operation or audio signal output.

Initialize

Select "OK" to initialize the unit to the factory default settings. All settings, DAB and FM station lists and presets will be deleted.

What is RDS?

Introduced by the European Broadcasting Union (EBU) in 1987, the Radio Data System (RDS) allows information such as station names to be received via the 57 kHz sub-carrier signal of FM broadcasts. However, the availability of RDS data varies depending on the area. It therefore may not be always be possible to receive RDS information.

Using the RDS functions

This radio supports the following RDS functions.

RDS function	Description
Station name display	Displays the station name you are listening to.
RT (radio text)	Displays the free-form textual information.

Notes

- The RDS functions will not be activated if the FM station being received is not transmitting RDS data. They may also not work properly in areas where RDS transmissions are in the experimental stage.
- If the radio signal being received is weak, it may take time to receive the RDS data.

PTY (programme type)

This function indicates services in programme type, such as News or Sports, transmitted in the DAB.

If the service does not transmit the programme type, "No PTY" appears.

Programme type	Display
No programme type	None
News	News
Current Affairs	Current Affairs
Information	Information
Sport	Sport
Education	Education
Drama	Drama
Culture	Arts
Science	Science
Varied	Talk
Pop Music	Pop Music
Rock Music	Rock Music
Easy Listening Music	Easy Listening
Light Classical	Light Classical
Serious Classical	Classical Music
Other Music	Other Music
Weather	Weather
Finance	Finance
Children's programmes	Children's
Social Affairs	Factual
Religion	Religion
Phone in	Phone in
Travel	Travel
Leisure	Leisure
Jazz Music	Jazz and Blues
Country Music	Country Music
National Music	National Music
Oldies Music	Oldies Music
Folk Music	Folk Music
Documentary	Documentary
Alarm Test	Alarm Test
Alarm	Alarm – Alarm I

Precautions

- Operate the unit only on the power sources specified in "Specifications." For AC operation, use only the supplied AC adaptor. Do not use any other type of AC adaptor.
- Failure to use the supplied AC adaptor may cause the unit to malfunction, as the polarity of the plugs of other manufacturers may be different.



- Avoid exposure to temperature extremes, direct sunlight, moisture, sand, dust or mechanical shock. Never leave in a car parked in the sun.

- Do not expose the unit to strong impact or excessive force. A glass material is used for the display in some models. If the glass chips or cracks, it may cause injury. In that case, stop using the unit immediately and make sure not to touch the damaged parts.

- Should any solid object or liquid fall into the unit, disconnect the AC adaptor, and have the unit checked by a qualified personnel before operating it any further.

- Since a strong magnet is used for the speakers, keep personal credit cards using magnetic coding or spring-wound watches away from the unit to prevent possible damage from the magnets.

- To clean the casing, use a soft dry cloth. Do not use any type of solvent, such as alcohol or benzine, which may damage the finish.

- Do not operate the unit with wet hands since it may cause a short circuit.

- Make sure not to splash water on the unit. This unit is not waterproof.

- When you do not use the unit for a long time, charge the battery every 6 months.

- Under certain circumstances, especially when the air is very dry, it is not uncommon to experience a discharge of static electricity, or shock, when your body comes in contact with another object, in this case the ear buds touching your ear(s). The energy from this natural discharge is extremely small and is not emitted by your product but rather a natural environmental occurrence.

- Listening at high volume levels over extended periods of time may harm your hearing. Be particularly careful when listening through headphones.

- Sudden loud output may harm your ears. Increase the volume gradually. Be particularly careful when listening through headphones.

- Do not use headphones while walking, driving a car or motorcycle, cycling, etc. A traffic accident may result.

- Do not use headphones in situations where being unable to hear ambient sound is dangerous, such as at railroad crossings, on train station platforms, and at construction sites.
- Excessive sound pressure from earphones and headphones can cause hearing loss.

If you have any questions or problems concerning your unit, please consult your nearest Sony dealer.

Troubleshooting

Should any problems persist after you have made the following checks, consult your nearest Sony dealer.

General

The unit beeps and the power does not turn on.

- If you press **⏻** when the remaining battery level is low, the unit will not turn on. Charge the unit by connecting the AC adaptor (supplied).

Display is dim, or no indication is displayed.

- The unit is being used in extremely high or low temperatures or in a place with excessive moisture.

The volume cannot be turned up when the unit is powered by the built-in battery.

- When the remaining battery level gets low (when the battery icon is empty), the maximum volume level is limited to "22." Charge the unit by connecting the AC adaptor (supplied).

The volume level is low in the "AUDIO IN" function compared with the volume level when listening to the radio.

- Adjust the volume on the connected device.

The unit enters standby mode automatically.

- By default, this unit is set to enter standby mode automatically after about 15 minutes of no operation or audio signal output. See "Auto power off" in "Setting Menu Options" for details.

Radio

Very weak or interrupted sound, or unsatisfactory reception.

- If you are in a building, listen near a window.
- Extend the antenna and adjust the length and the angle for best reception.
- If a mobile phone is placed close to the unit, a loud noise may be heard from the unit. Keep the phone away from the unit.

A desired station cannot be received when a preset button is pressed.

- Make sure you have selected the desired band (DAB or FM) before you press the preset button. One station for each band can be set to each button.
- You may have held down the preset button to which the station was assigned, causing the station to be replaced by a new one. Assign the desired station again.
- Preset buttons cannot be used when the setting menu is displayed.
- If you have moved to another region, perform the auto tune again. (See "To make a new DAB/FM station list" for details.) Then assign the new station to a preset button.

If the unit still does not operate properly

Try pressing **RESET** on the bottom using a thin rod. The unit will restart, retaining the user-configured settings.

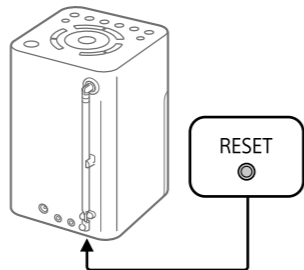

If maintenance service is performed

All user-configured settings, such as preset radio stations, the timer settings, and the clock, may be initialized. Please note your settings in case you need to configure them again.