

Single Locking Cable Tie

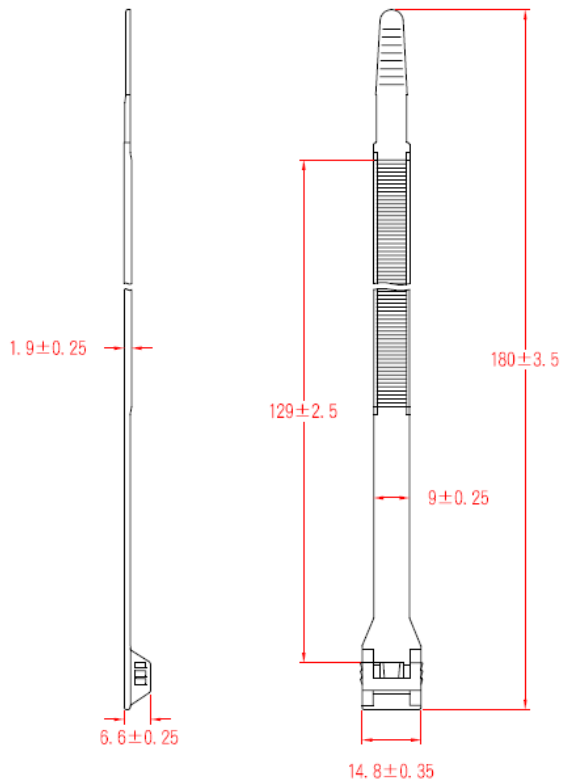

Material: UL 94V-2, Nylon 66

Length: 180 mm

Wide: 9 mm

Max. Bundle Dia.: 40 mm

Min. Loop Tensile Strength: 36 kgs