

Cyclon®



CYCLON®

CYCLON® BATTERY SELECTION GUIDE

TABLE OF CONTENTS

Company background

EnerSys®	3
Services and applications	3
Features and benefits	5

Technical information

Capacity as a function of temperature	7
State of charge.....	7
Storage time as a function of temperature.....	7
Charging recommendations.....	7

CYCLON® Battery Single Cells

CYCLON® product family.....	8
CYCLON® battery alternate configurations	9
CYCLON® battery standard descriptions	9
CYCLON® battery Single Cell performance specifications	10
CYCLON® battery Single Cell standard assemblies	11
CYCLON® battery BC Single Cell performance specifications.....	12
CYCLON® battery Single Cell mechanical specifications	13
CYCLON® battery BC Single Cell mechanical specifications	13

CYCLON® Battery Monobloc

4V/6V Monobloc performance specifications	14
4V/6V Monobloc standard assemblies.....	15
4V/6V Monobloc mechanical specifications.....	16

Quick reference list

Standard product listing.....	17
-------------------------------	----



EnerSys® Value-Added Services

In addition to our manufacturing capability, EnerSys® is proud to provide its customers with the following services:

- Customised manufacturing design
- Battery recycling
- Online technical information
- Charging support
- Product testing
- On-site technical seminars
- Battery samples
- Application engineering
- Technical documentation
- Charger evaluation to determine compatibility with CYCLON® batteries

Applications

Batteries from the EnerSys “pure lead” family are used in a wide variety of standby and portable/ cyclic applications including those in:

- Telecommunications
- Electronics
- Uninterruptible power supplies
- Defence installations
- Aviation (may require appropriate agency certification/approval for installation in aircraft)
- Computer back-up
- Electric vehicles
- Medical equipment
- Solar power
- Rail
- Lawn and garden equipment
- Extreme temperature environments (-65°C to +80°C) for single cells

CYCLON battery Single Cells and Monoblocs should be handled with care. Batteries are shipped without individual cell terminal protection and there is a risk of short circuit if not handled correctly.

Cyclon®

**Wherever the world
needs stored energy,
EnerSys® is there.**

Powered by more than 100 years of expertise, EnerSys® is the world's largest industrial battery manufacturer, operating 21 facilities worldwide. Along with manufacturing and distributing a wide range of reserve power and motive power batteries, chargers, power equipment, and battery accessories, EnerSys provides unmatched aftermarket and customer support to its customers in over 100 countries worldwide.



The EnerSys® plant in Warrensburg, Missouri covers 32,000 square feet and is situated on 33 acres.

Powerful design

Resealable safety valve

A 50-PSI vent lets gases escape, then automatically reseals, so there's no risk of excessive gas accumulation within the battery, or "dry out" failure from repeated recharges.

Pure lead plates

Made from 99.99% pure lead, CYCLON® battery plates are extremely thin, so they offer more surface area than conventional batteries – and far more power.

AGM plate separator

High-purity acid is absorbed right into the Absorbed Glass Mat (AGM) plate separators, so the CYCLON battery provides leak-proof operation in any position.

Steel can enclosure

The CYCLON battery's metal outer jacket offers extreme shock, vibration, temperature, and flammability protection.

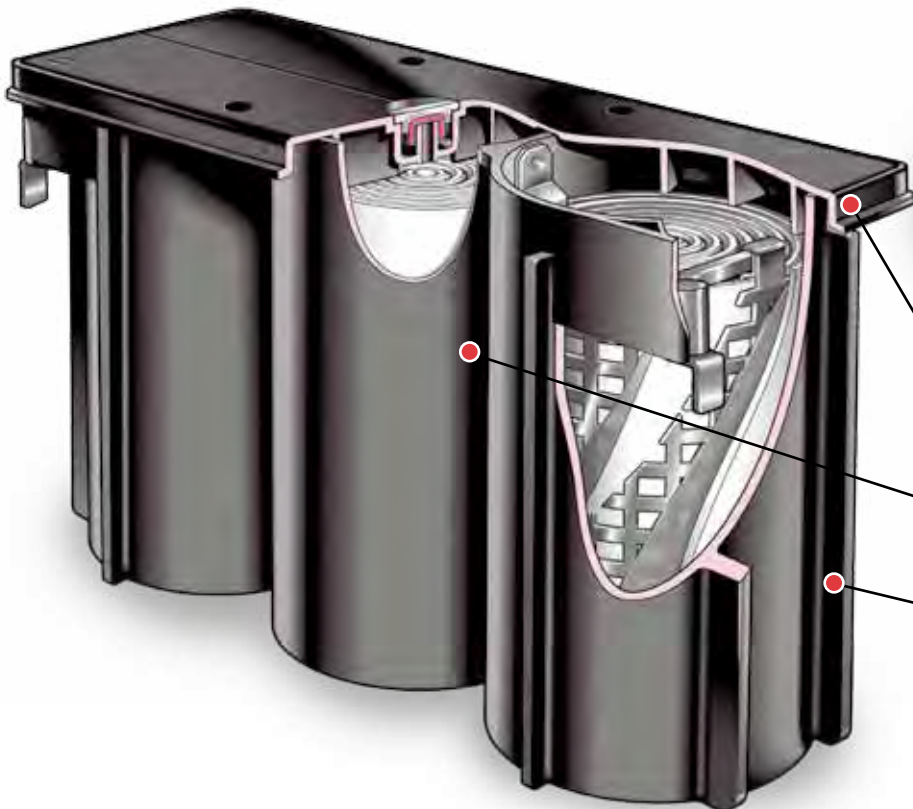
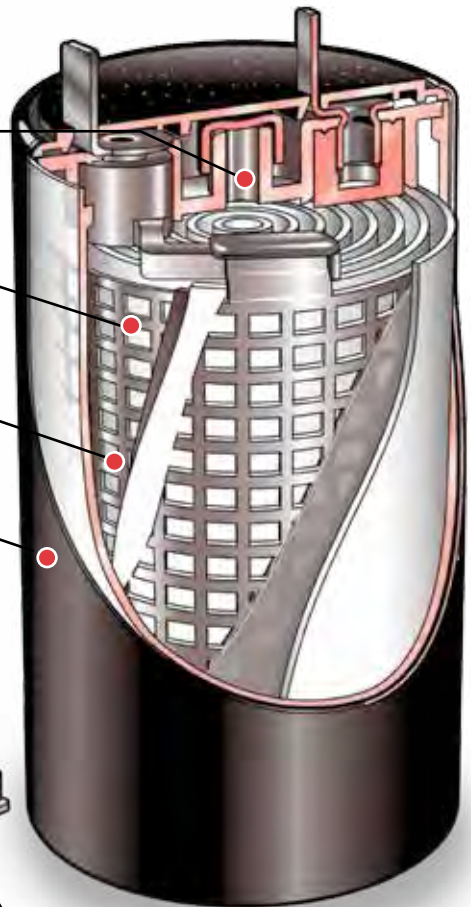

One-piece plastic cover

Direct through-the-wall intercell connections

One-piece plastic case

Features and Benefits

Sealed pure-lead cells were invented by the Gates Corporation in 1973. The purity of the materials used is key to supporting the CYCLON® battery's performance benefits. A longer service life, meaning fewer replacements and the cost associated with it, combined with higher reliability and fewer system failures, result in a lower long-term cost of ownership to the end user or equipment owner.

What are the advantages of EnerSys® technology?

1. Power density - Per unit weight, the power provided by pure lead products offers the greatest high-rate power density for your energy budget. CYCLON® battery's greater volumetric power allows engineers to consider more energy-supporting features or design smaller, lighter packages.

At high-rate and pulse discharges, EnerSys® CYCLON® batteries offer the best performance value when compared with competitive product in applications at less than 100 minutes of discharge.

2. Cycle life - Compared to competitive lead products (offering up to 200 full cycles), pure lead batteries provide 50% to 200% greater full cycle capability. CYCLON® batteries will deliver up to 300 cycles (100% DOD, C/5). And, because CYCLON® batteries incorporate a high vent-pressure design, EnerSys products experience no "dry out" failure mode from repeated recharges.

3. Float life - Conventional sealed-lead batteries vary greatly in specified standby life: from three to six years at 20°C, C/20. CYCLON® battery Single Cells, however, offer a ten-year design life at 25°C, C/5, to 80% of rated capacity. At 20°C, CYCLON® battery Single Cells offer a fifteen-year design life.

4. High stable voltage delivery - The high stable voltage delivery of a pure lead battery results from its low internal resistance. The flat discharge voltage profile of our batteries, similar to nickel cadmium, combined with our products' low internal resistance, means our batteries are able to discharge and recharge their power more quickly and efficiently and offer greater application flexibility. The pure lead construction also gives more watts-per-unit weight at high discharge rates.

5. Safety - Since CYCLON® battery Single Cells and Monoblocs emit minimal to no gassing under normal charging conditions they are safe for installation in offices, aircraft cabins, hospitals or any other environment occupied by human beings. Underwriters Laboratories (UL) recognises all CYCLON® cells and batteries as components.

6. Widest temperature range - Due to the products' strong construction and high vent pressures, these cells will maintain their performance and physical parameters in extreme conditions. At high temperatures, the chemical reaction in a battery that causes aging is accelerated. Pure lead technology resists that chemical reaction more effectively than alloyed lead, thus allowing a battery to have a longer service life. At high temperatures, when conventional lead batteries experience internal moisture loss from venting and case side wall distention, the CYCLON® Single Cell battery, with its steel can (jacket) and 50psi vent, does not experience these life-robbing conditions. CYCLON® batteries have twice the delivered capacity of conventional sealed-lead batteries at temperatures below -20°C, offering unparalleled low-temperature performance.

Our batteries have thinner plates, and therefore greater plate surface area than conventional sealed-lead, thick plate batteries. As a result our batteries can reach a high state of charge in fast-charging applications in one-fourth the time of conventional, sealed-lead, thick-plate batteries. This is 50% to 100% overall better performance for your energy dollar.

7. Rugged construction - Due to their strong external packaging and internal pure lead composition, EnerSys® products can withstand not only extreme temperatures but also harsh usage.

CYCLON® battery Single Cells are available housed in cases constructed of UL 94V-0 flame retardant rated material. The CYCLON® battery Single Cell itself is in a metal jacket giving added flammability protection. CYCLON® batteries are shock and vibration resistant, designed to offer higher tolerance levels to meet demanding applications, including those in commercial and outdoor applications. The company's focus on battery-case integrity and high vent pressure, coupled with pure lead's low grid-corrosion rate, means CYCLON® battery cells and Monoblocs provide the longest service life possible.

CYCLON® Battery Single Cell/Monobloc comparison chart

	Design	Construction	Operating range	Voltages
Single Cells	3 atm venting pressure	Metal outer case & spiral construction	-65°C to +80°C	2 volt cells
Monobloc	0.5 atm venting pressure	Plastic outer case & spiral construction	-40°C to +40°C	4 & 6 volt units

The pure lead advantage

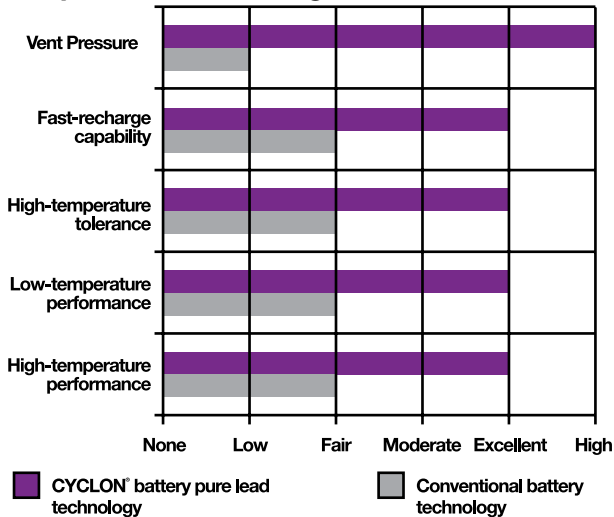

Each plastic Monobloc consists of Single Cell elements, internally connected to provide a 4 or 6 volt unit. Monoblocs or Single Cells can be connected in series or parallel to achieve the required voltage or capacity. Monoblocs and Single Cells are supplied with spade terminals making electrical connections quick and easy. Additionally, EnerSys® products offer the highest vent pressure in the market. As a result, our batteries are more resistant to venting and dryout from continuous overcharge in standby applications.

- 8. Fastest recharge** - EnerSys® pure lead chemistry allows our batteries and cells to offer the highest recharge efficiency of any sealed-lead battery on the market. With pure lead, you can achieve a 95% state of recharge in less than one hour - without loss of capacity or electrolyte using conventional constant-voltage charging techniques.

Flexible charging options are possible with CYCLON® battery Single Cells and Monoblocs, as no current limit is required when using a constant voltage charger.

- 9. Orientation/placement/transport** - Due to the products' mechanical design, CYCLON® batteries can be mounted and operated in any position, an attractive feature for less accessible areas.

CYCLON® battery Single Cells offer UL 94V-0 flame-retardant packaging, thus allowing the mounting of systems in sensitive areas and human environments. Plus, the unique and flexible 2-volt CYCLON® battery Single Cell allows you to design your system using an almost infinite number of packaging/design configurations.

CYCLON® single cells and monoblocs are classified as “non spillable batteries” and are exempted from comprehensive hazardous packaging requirements. When shipped from the point of manufacture the product complies with the relevant requirements of IATA and 49 CFR 173.159(d), specifically CYCLON® product has been tested and found to comply with IATA Packing instruction 806 and Special Provision A67. As such CYCLON® product does not have an assigned UN number and is not required to be shipped under a proper shipping name.

When shipping CYCLON® product, all cells **must** be protected against short circuit and the outer packaging should be plainly and durably marked as “**Non Spillable or Non Spillable Battery**”. This applies when product is repackaged at other locations. It is recommended that short circuit protection is continued to be applied when storing and handling CYCLON® product.

CYCLON® battery Single Cells and Monoblocs have been tested and determined to be in compliance with the vibration and pressure differential tests contained in 49 CFR § 173.159(d).

Because CYCLON® battery Single Cells and Monoblocs are classified as “Nonspillable” and meet the conditions above, [from § 173.159(d)] they do not have an assigned UN number nor do they require additional DOT hazard labeling.

The regulation change effective September 1995, was to clarify and distinguish to shippers and transporters, all batteries that have been tested and determined to be in compliance with the DOT Hazardous Material Regulations, the International Civil Aeronautics Organisation (ICAO), and the International Air Transport Association (IATA) Packaging Instruction 806 and Special Provision A67, and therefore exempted from all other requirements of these regulations and classified as a “nonspillable battery”.

- 10. Shelf life** - Pure lead batteries have an extremely low self-discharge rate, thus providing extended storage capability while maintaining high state-of-charge levels for dependable operation.

CYCLON® battery Single Cells and Monoblocs have a shelf life more than two times that of conventional lead batteries. To assure maximum reliability, EnerSys recommends that all stored cells/batteries be recharged (boost charged) once every 24 months or when the open circuit voltage drops to 2.00 volts per cell, whichever occurs earlier. Inventory should be checked more frequently if storage temperature regularly exceeds 25°C.

Capacity as a function of temperature for CYCLON® Battery Single Cells & Monoblocs (use graph up to 40°C for Monoblocs)

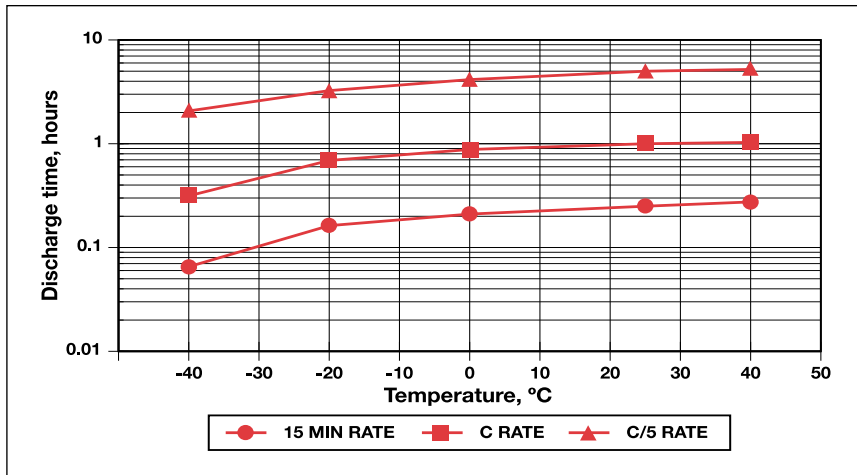

State of charge for CYCLON® Battery Single Cells & Monoblocs

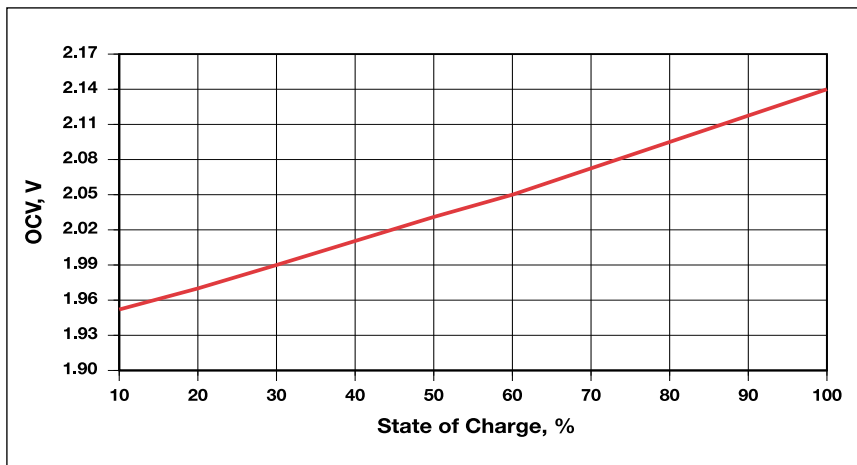
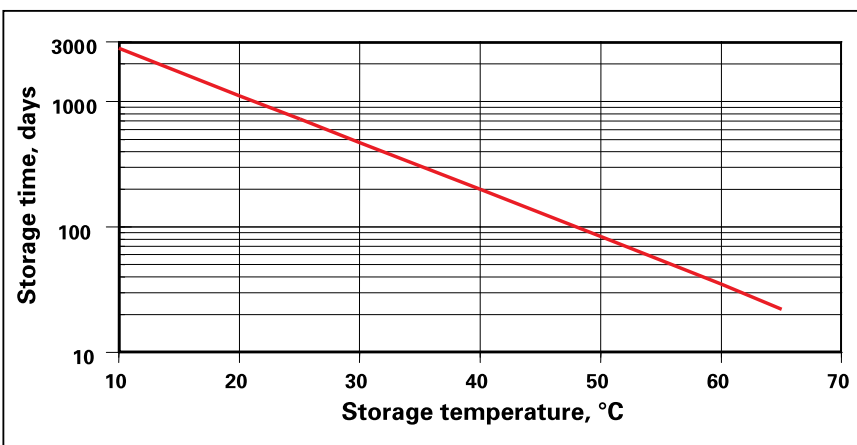

Figure 5-2: CYCLON® Battery Storage Time Vs. Temperature



Charging recommendations:

Broadly speaking, a battery may be recharged using either a constant voltage (CV) charger or a constant current (CC) charger, or a modification of either or both of these.

The exact regime chosen generally depends upon the time and economic constraints imposed by the system. Constant current charging is widely used in cyclic applications where a recharge must be accomplished in a relatively short time period. Constant voltage charging, where a single voltage level is applied across the battery terminals, is the most suitable method to recharge CYCLON® batteries. Depending on the CV charger's current limit, it is possible to recharge these batteries from a 100% discharged condition to better than 95% state of charge in less than one hour, using only the cyclic charge voltage.

Constant voltage charging

Constant voltage (CV) charging should be within the following ranges:

Fast Chargers, Per cell:

2.40 to 2.45 volts @ 25°C

12 volts:

14.40 to 14.70 volts @ 25°C

(for a maximum of 16-20 hours)

In cyclic applications, where the battery is being significantly discharged at a frequency greater than once per week, the charge voltage should be a nominal value of 2.40 Volts per cell (VPC), but can range between 2.35 VPC and 2.45 VPC to maximise cycle life.

Float Chargers, Per cell:

2.27 to 2.35 volts @ 25°C

12 volts:

13.62 to 14.10 volts @ 25°C

Nominal float voltage is 2.27 VPC at 25°C, but float voltage can range between 2.25 VPC (@25°C) and 2.35 VPC (@25°C) depending on the details of the application. Voltages nearer 2.35 VPC would be used in applications which are float in nature, but could have frequent discharges of significant Depth of Discharge (DOD).

To avoid thermal runaway in warmer temperatures, and to improve charge acceptance in colder temperatures, the charger voltage should be compensated by approximately 3 millivolts per cell per degree Centigrade variance from 25°C. This is a negative coefficient, with the voltage being lowered as the temperature increases, and vice versa.

There is no need to limit the inrush current to the battery during constant voltage charging. The low internal resistance of EnerSys® CYCLON® battery Single Cells and Monoblocs allows for large inrush current without damage.

Since not all of the charge returned is accepted to replenish the electro-chemical potential, a good rule of thumb to use is that the charge returned should be 105% to 110% of the capacity delivered on the previous discharge.

Most current waveforms are not pure DC nor are they pure sine waves. Therefore, consult the EnerSys® Application Support Department for assistance when evaluating the charger current waveforms for your specific application.

A three-step 6-8 hour charge profile optimised for CYCLON® cells and batteries is available on request from the Technical Support Department of EnerSys®.

CYCLON® Battery Product Family (All capacities at 10 hr. rate 25°C to 1.67Vpc)

CYCLON® Battery 2V Single Cell:

Products	Capacity	Part Number	Internal res. of fully charged Monobloc mΩ @ 25°C	Nominal short circuit current for charged cell	DIMENSIONS				
					Length mm	Width mm	Height mm	Weight g	Tabs mm
D cell	2.5Ah	0810-0004	5.0	400A	34.3	61.2	68.1	178.0	4.75x0.64
DT cell	4.5Ah	0860-0004	5.0	400A	34.3	96.0	102.9	274.4	4.75x0.64
X cell	5.0Ah	0800-0004	3.5	570A	2.87	3.21	12.77	362.0	6.35x0.64
E cell	8.0Ah	0850-0004	3.0	665A	44.5	100.1	108.7	489.9	6.35x0.64
J cell	12.0Ah	0840-0004	2.5	800A	51.8	123.2	135.6	839.2	92x0.81
BC cell	25Ah	0820-0004	1.5	1335A	65.3	158.8	173.2	1669.2	M6 (-) and M8 (+) terminals

CYCLON® Battery 4V Monoblocs:

Products	Capacity	Part Number	Internal res. of fully charged Monobloc mΩ @ 25°C	Nominal short circuit current for charged cell	DIMENSIONS				
					Length mm	Width mm	Height mm	Weight kg	Tabs mm
D cell	2.5Ah	0819-0010	10.0	400A	79.5	46.0	69.9	.80	4.75x0.64
X cell	5.0Ah	0809-0010	7.0	570A	96.5	53.8	76.7	1.62	6.35x0.64
E cell	8.0Ah	0859-0010	6.0	665A	96.8	54.1	101.6	2.11	6.35x0.64

CYCLON® Battery 6V Monoblocs:

Products	Capacity	Part Number	Internal res. of fully charged Monobloc mΩ @ 25°C	Nominal short circuit current for charged cell	DIMENSIONS				
					Length mm	Width mm	Height mm	Weight kg	Tabs mm
D cell	2.5Ah	0819-0012	15.0	400A	113.8	46.0	69.9	.52	4.75x0.64
X cell	5.0Ah	0809-0012	10.0	570A	139.2	53.8	76.7	.98	6.35x0.64
E cell	8.0Ah	0859-0012	8.0	665A	139.2	54.1	101.6	1.43	6.35x0.64

CYCLON® Battery Single Cell

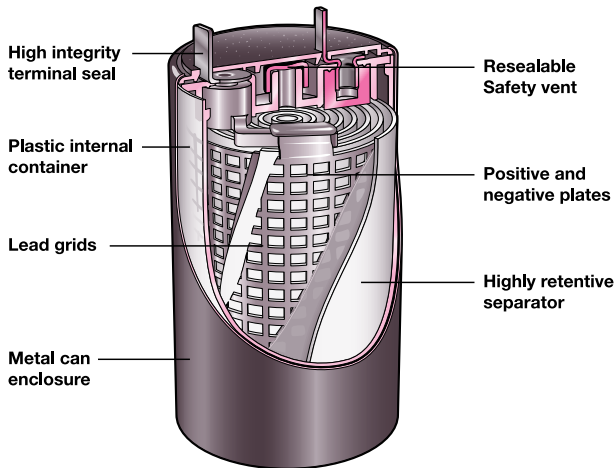

Alternative battery configurations

Standard battery configurations are rectangular in overall shape. A sample of other possible configurations are illustrated below. These can be held together with tape (offering the lowest cost and minimum electrical and mechanical protection) or by shrink wrapping. The CYCLON® battery Single Cell can be custom configured in virtually an infinite number of designs.

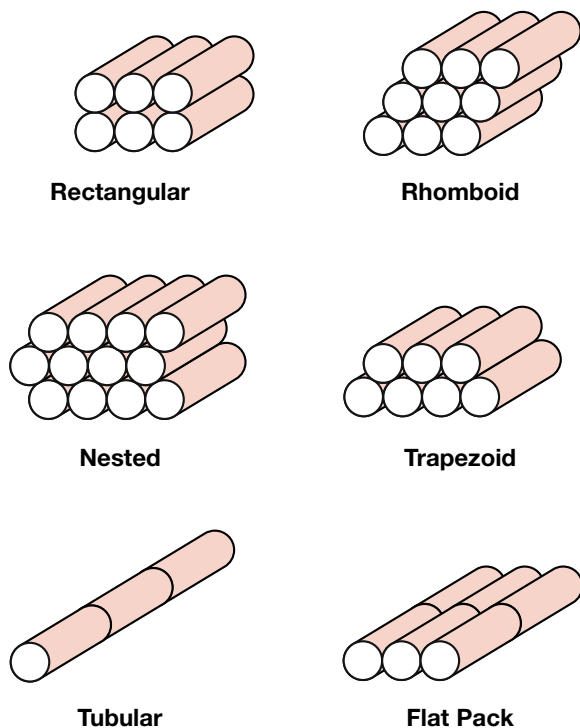

CYCLON® battery standard descriptions

CYCLON® battery cells are ideal for small ampere-hour applications up to 25Ah. The sealed-lead construction uses a starved-electrolyte system and a patented grid-alloy providing numerous advantages.

Standard batteries are offered based on combinations of the previously described CYCLON® battery cells and are available in 6 and 12 volt configurations with capacities ranging from 2.5Ah to 25Ah.

Battery Packages

Rigid plastic cases or shrink wrap packaging are available.

Rigid Plastic

Cases are available for most designs in either flame-retardant ABS material, meeting UL 94V-0 flammability rating, or Styrene (available only in 2X3 D and X battery configurations). Some cases have mounting holes. Rigid plastic cases are recommended for applications in which the battery must withstand vibration, movement or extreme weather conditions.

Shrink Wrap

Shrink wrap packaging is less expensive and smaller in size and weight. A plastic extrusion insulates the battery top and keeps the cells in line. A heavy duty shrink sleeve holds the cells firmly in place. Shrink wrap packaging is recommended for applications in which the battery remains stationary.

Battery Terminations for Single Cell and Monoblocs

Tab/Stud

Cell size	Dimensions
D	4.75mm x 0.64mm
DT	4.75mm x 0.64mm
X	6.35mm x 0.64mm
E	6.35mm x 0.64mm
J	7.92mm x 0.81mm
BC	6mm post (negative) 8mm post (positive)

Tab Adapters (D, DT, X, and E)

Available to convert 4.75mm tabs to 6.35mm tabs, 0.81mm thick, and vice-versa.

BC Quick Disconnect Terminals

AMP series 250 Faston terminals are available for BC batteries.

Connection Terminations

A wide variety of terminations are offered. For recommendations or to specify; contact your EnerSys® Territory Manager or battery assembler.

Fusible Links

Specify your requirement.

Lead Wires

Stranded copper wire with insulation meeting UL1015 specifications (Red +, Black -). Standard leads extend 9 inches outside the battery pack. Ends are stripped and dipped in wax, which must be removed before use.

Standard wire gauges are:

D batteries	18AWG, UL1015
DT batteries	16AWG, UL1015
X batteries	16AWG, UL1015
E batteries	14AWG, UL1015
J batteries	14AWG, UL1015
BC batteries	12AWG, UL1015

UL - Underwriters Laboratories
AWG - American Wire Gauge

Varying lead lengths and gauges are also available; please specify to your EnerSys® Territory Manager or battery assembler.

Intercell Connections

Standard

D, DT, X and E batteries—welded tin-plated steel connector

J batteries—soldered, stranded wire

BC batteries—solid copper

For vibration-prone applications

D, DT, X, E and J batteries—soldered, stranded wire

BC batteries—braided copper straps

CYCLON® Battery Single Cell performance specifications

Constant current discharge/amps to 1.67Vpc @ 25°C

Products	DURATION									
	5 min	10 min	15 min	30 min	60 min	90 min	5 hr	8 hr	10 hr	20 hr
D cell (2.5Ah)	14.8	8.1	5.9	3.4	1.9	1.4	.48	.32	.26	.13
DT cell (4.5Ah)	25.2	15.0	11.2	6.6	3.7	2.6	.85	.55	.45	.24
X cell (5.0Ah)	27.3	17.8	13.2	7.0	3.9	2.8	.96	.61	.50	.26
E cell (8.0Ah)	41.7	26.4	19.0	11.0	6.2	4.4	1.6	1.0	.81	.42
J cell (12.0Ah)	51.7	38.1	29.4	18.0	9.2	6.5	2.3	1.5	1.20	.66

Constant power discharge/watts per cell to 1.67Vpc @ 25°C

Products	DURATION									
	5 min	10 min	15 min	30 min	60 min	90 min	5 hr	8 hr	10 hr	20 hr
D cell (2.5Ah)	26.4	16.1	11.6	6.7	3.8	2.7	.94	.61	.50	.25
DT cell (4.5Ah)	45.0	28.1	21.0	12.5	7.1	5.1	1.7	1.1	.90	.46
X cell (5.0Ah)	45.4	31.9	23.9	13.9	7.8	5.6	1.9	1.2	1.0	.51
E cell (8.0Ah)	77.8	51.0	35.5	21.1	12.4	8.9	3.1	2.0	1.6	.85
J cell (12.0Ah)	90.4	68.4	53.4	31.6	18.3	13.2	4.7	3.0	2.3	1.3

Charging/Temperature/Life:

Products	CHARGING PER CELL		TEMPERATURE RANGE		LIFE EXPECTANCY	
	Cyclic	Float	Storage & discharge	Charge	C/5 Cycle life 100% DOD	Float life at 25°C (20°C)
D, DT, X, E & J cell	CV 2.40 - 2.45 CC*	CV 2.27-2.35 CC*	-65°C to +80°C	-40°C to -80°C	300	10 years (15 years)

Maximum recommended storage time before recharge - 24 months @ 25°C or 2.0Vpc, whichever is earlier

Atmospheric pressure range - Vacuum to 8 atmospheres

*Users planning to use CC should consult the EnerSys® Application Support Department.

UL Recognised Component. Meets UL 1989

Caution: Batteries contain toxic materials (Pb and H2SO4) • Avoid short circuit • Do not charge in gas-tight container

Sealed-lead rechargeable battery must be recycled or disposed of properly. Contact your local EnerSys® Customer Service Department for details.



CYCLON® Battery Single Cell standard assemblies

CYCLON® Battery 6 Volt 1x3 Shrink Wrap

Product Number	Description	Length mm	Width mm	Height mm	Weight kg	Leads
0810-0102	2.5Ah D Dbl. Slot	102.9	37.6	67.6	.56	No
0810-0103	2.5Ah D	102.9	37.6	67.6	.57	Yes
0860-0102	4.5Ah DT Dbl. Slot	102.9	37.6	102.4	.94	No
0860-0103	4.5Ah DT	102.9	37.6	102.4	.95	Yes
0800-0102	5.0Ah X Dbl. Slot	133.4	47.5	79.2	1.13	No
0800-0103	5.0Ah X	133.4	47.5	79.2	1.14	Yes
0850-0102	8.0Ah E Dbl. Slot	133.4	47.5	106.4	1.58	No
0850-0103	8.0Ah E	133.4	47.5	106.4	1.60	Yes



CYCLON® Battery 6 Volt 1x3 ABS Case

Product Number	Description	Length mm	Width mm	Height mm	Weight kg	Leads
0810-0011	2.5Ah D Dbl. Slot	107.4	39.4	69.9	.60	No
0810-0077	2.5Ah D Sing. Slot	107.4	39.4	69.9	.62	Yes
0800-0011	5.0Ah X Dbl. Slot	138.2	49.8	80.3	1.23	No
0800-0071	5.0Ah X Sing. Slot	138.2	49.8	80.3	1.24	Yes



CYCLON® Battery 12 Volt 2x3 Shrink Wrap

Product Number	Description	Length mm	Width mm	Height mm	Weight kg	Leads
0810-0114	2.5Ah D Dbl. Slot	102.9	71.6	67.8	1.13	No
0810-0115	2.5Ah D	102.9	71.6	67.8	1.14	Yes
0860-0114	4.5Ah DT Dbl. Slot	102.9	71.6	102.4	1.76	No
0860-0115	4.5Ah DT	102.9	71.6	102.4	1.77	Yes
0800-0114	5.0Ah X Dbl. Slot	133.4	93.5	79.5	2.24	No
0800-0115	5.0Ah X	133.4	93.5	79.5	2.26	Yes
0850-0114	8.0Ah E Dbl. Slot	133.4	93.5	106.4	3.05	No
0850-0115	8.0Ah E	133.4	93.5	106.4	3.07	Yes



CYCLON® Battery 12 Volt 2x3 ABS and Styrene Cases

Product Number	Description	Length mm	Width mm	Height mm	Weight kg	Leads
0810-0008	2.5Ah D Dbl. Slot	107.4	73.2	69.1	1.22	No
0810-0067*	2.5Ah D (Styrene)	107.4	75.4	69.3	1.19	Yes
0800-0008	5.0Ah X Dbl. Slot	138.2	94.0	79.8	2.42	No
0800-0047*	5.0Ah X (Styrene)	138.2	94.0	81.0	2.37	Yes



CYCLON® Battery 12 Volt 1x6 Shrink Wrap

Product Number	Description	Length mm	Width mm	Height mm	Weight kg	Leads
0810-0108	2.5Ah D Dbl. Slot	205.2	37.6	67.6	1.13	No
0810-0109	2.5Ah D	205.2	37.6	67.6	1.14	Yes
0860-0108	4.5Ah DT Dbl. Slot	205.2	37.6	102.4	1.76	No
0860-0109	4.5Ah DT	205.2	37.6	102.4	1.77	Yes
0800-0108	5.0Ah X Dbl. Slot	266.2	47.5	79.2	2.27	No
0800-0109	5.0Ah X	266.2	47.5	79.2	2.28	Yes
0850-0108	8.0Ah E Dbl. Slot	266.2	47.5	106.4	3.05	No
0850-0109	8.0Ah E	266.2	47.5	106.4	3.07	Yes



CYCLON® Battery 12 Volt 1x6 ABS Case

Product Number	Description	Length mm	Width mm	Height mm	Weight kg	Leads
0810-0016	2.5Ah D Dbl. Slot	209.6	39.4	69.6	1.24	No
0810-0075	2.5Ah D Sing. Slot	209.6	39.4	69.6	1.25	Yes
0800-0016	5.0Ah X Dbl. Slot	270.8	49.8	80.0	2.36	No
0800-0072	5.0Ah X Sing. Slot	270.8	49.8	80.0	2.38	Yes

All dimensions, excluding weight, are maximum

*Due to special assembly, consult your local EnerSys® Customer Service Department for availability.

CYCLON® Battery BC Single Cell performance specifications

Constant current discharge/amps to 1.67Vpc @ 25°C

Products	DURATION									
	5 min	10 min	15 min	30 min	60 min	90 min	5 hr	8 hr	10 hr	20 hr
BC cell (2.5Ah)	118.3	72.8	54.3	32.2	19.3	14.0	4.85	3.14	2.55	1.33

Constant current discharge/watts per cell to 1.67Vpc @ 25°C

Products	DURATION									
	5 min	10 min	15 min	30 min	60 min	90 min	5 hr	8 hr	10 hr	20 hr
BC cell (2.5Ah)	197.3	142.4	105.5	63.5	36.8	25.6	9.20	6.04	4.95	2.60

Charging/Temperature/Life:

Products	CHARGING PER CELL		TEMPERATURE RANGE		LIFE EXPECTANCY	
	Cyclic	Float	Storage & discharge	Charge	C/5 Cycle life 100% DOD	Float life at 25°C (20°C)
BC cell (2.5Ah)	CV 2.40 - 2.45 CC*	CV 2.27-2.35 CC*	-65°C to +80°C	-40°C to +80°C	300	10 years (15 years)

Maximum recommended storage time before recharge - 24 months @ 25°C or 2.0Vpc, whichever is earlier

Atmospheric pressure range - Vacuum to 8 atmospheres

Mounting - Terminal torque must not exceed 3.95 Nm

*Users planning to use CC should consult the EnerSys® Application Support Department



CYCLON® Battery 12 Volt 2x3 25.0Ah Case

Product Number	Description	Length mm	Width mm	Height mm	Weight kg	Leads
0820-2018	BC Double Slot, Copper Straps	204.5	138.4	184.2	10.4	Yes
0820-0020	BC Double Slot, Copper Straps	204.5	138.4	184.2	10.4	No

All dimensions, excluding weight, are maximum

UL Recognised Component. Meets UL 1989

Caution: Batteries contain toxic materials (Pb and H₂SO₄) • Avoid short circuit • Do not charge in gas-tight container

Sealed-lead rechargeable battery must be recycled or disposed of properly. Contact your local EnerSys® Customer Service Department for details.

CYCLON® Battery Single Cell mechanical specifications (E, G, H & J - Maximum)

Products	DIMENSIONS										Weight gm
	A mm	B mm	C mm	D	E mm	F mm	G mm	H mm	I mm	J mm	
D cell	6.9	13.0	4.75	22°	6.9	0.64	61.2	1.3	3.3	34.3	178.0
DT cell	6.9	13.0	4.75	22°	6.9	0.64	96.0	1.3	3.3	34.3	274.4
X cell	7.4	15.5	6.35	22°	8.6	0.64	72.9	1.5	3.6	44.5	362.0
E cell	7.4	15.5	6.35	22°	8.6	0.64	100.1	1.5	3.6	44.5	489.9
J cell	8.1	18.8	7.92	22°	12.4	0.81	123.2	1.3	3.8	51.8	839.2

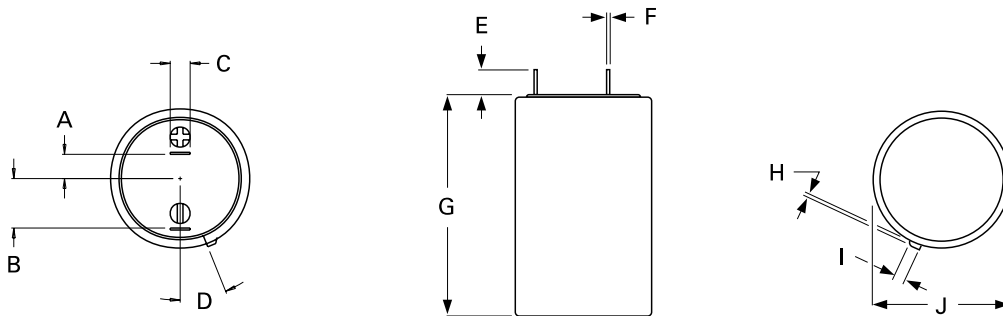

CYCLON® Battery BC Single Cell mechanical specifications (F, G & I - Maximum)

Products	DIMENSIONS									Weight kg
	A mm	B mm	C	D mm	E mm	F mm	G mm	H mm	I mm	
BC cell	16.5	33.0	22	14.5	5.6	158.8	1.5	3.3	65.3	1.67

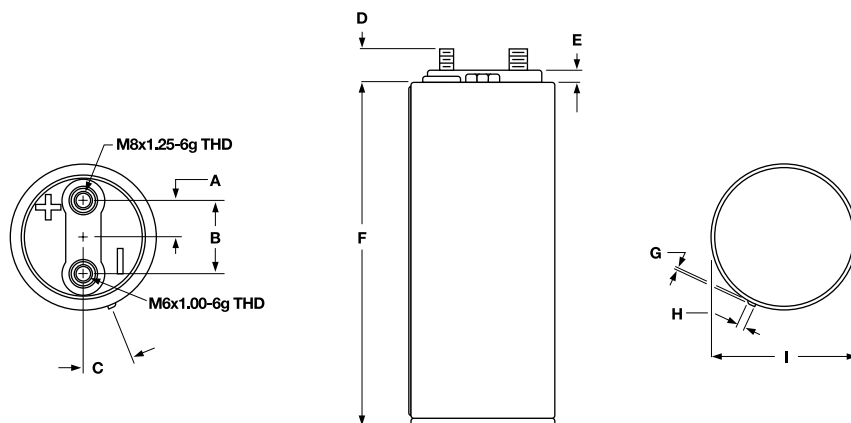

For CYCLON® Battery Single Cell constant current (CC) discharge and constant power (CP) discharge information, please refer to the CYCLON® Application Manual - Appendix A, Figure A-1 and Figure A-2, respectively.

CYCLON® Battery 4V/6V Monobloc performance specifications

4V & 6V Constant current discharge/amps to 1.67Vpc @ 25°C

Products	DURATION									
	5 min	10 min	15 min	30 min	60 min	90 min	5 hr	8 hr	10 hr	20 hr
D cell (2.5Ah)	14.3	8.1	5.9	3.4	1.9	1.4	.48	.32	.26	.13
X cell (5.0Ah)	28.9	18.1	13.5	7.1	4.0	2.8	1.0	.61	.52	.26
E cell (8.0Ah)	41.7	26.4	19.0	11.0	6.2	4.4	1.6	1.0	.81	.42

4V & 6V Constant power discharge/watts per cell to 1.67Vpc @ 25°C

Products	DURATION									
	5 min	10 min	15 min	30 min	60 min	90 min	5 hr	8 hr	10 hr	20 hr
D cell (2.5Ah)	25.3	15.9	11.7	6.8	3.8	2.7	.93	.60	.49	.25
X cell (5.0Ah)	48.8	32.3	24.2	13.8	7.8	5.6	2.0	1.2	1.0	.52
E cell (8.0Ah)	77.8	51.0	35.5	21.1	12.4	8.9	3.1	2.0	1.7	.85

Charging/Temperature/Life

Products	CHARGING PER CELL		TEMPERATURE RANGE		LIFE EXPECTANCY	
	Cyclic	Float	Storage, discharge & charge	Safety pressure relief valve	C/5 Cycle life 100% DOD	Float life at 25°C (20°C)
4V D, X, & E Monobloc	CV 4.80 - 4.90 CC*	CV 4.54-4.70 CC*	-40°C to +40°C	8 psi	300	Up to 8 yrs (Up to 8 yrs)
6V D, X, & E Monobloc	CV 7.20 - 7.35 CC*	CV 6.81-7.05 CC*	-40°C to +40°C	8 psi	300	Up to 8 yrs (Up to 8 yrs)

Maximum recommended storage time before recharge - 24 months @ 25°C or 2.0Vpc, whichever is earlier

Atmospheric pressure range - Vacuum to 2 atmospheres

Mounting - Each Monobloc is equipped with mounting holes in the cover. The tightening torque for mounting the Monobloc is 2.83 Nm. When using 4 mounting bolts, small spacers (washers) 1 to 3 mm thick should be placed between the battery and the mounting surface to prevent bowing or stressing the battery case.

*Users planning to use CC should consult the EnerSys® Application Support Department.

UL Recognised Component. Meets UL 1989

Caution: Batteries contain toxic materials (Pb and H₂SO₄) • Avoid short circuit • Do not charge in gas-tight container Sealed-lead rechargeable battery must be recycled or disposed of properly. Contact your local EnerSys® Customer Service Department for details."



CYCLON® Battery 4V/6V Monobloc standard assemblies

CYCLON® Battery 4 Volt Monoblocs

Product Number	Description	Length mm	Width mm	Height mm	Weight kg
0819-0010	4V, 2.5Ah Monobloc	79.5	46.0	69.9	.36
0809-0010	4V, 5.0Ah Monobloc	96.5	53.8	76.7	.74
0859-0010	4V, 8.0Ah Monobloc	96.8	54.1	101.6	.96



CYCLON® Battery 6 Volt Monoblocs

Product Number	Description	Length mm	Width mm	Height mm	Weight kg
0819-0012	6V, 2.5Ah Monobloc	113.8	46.0	69.9	.52
0809-0012	6V, 5.0Ah Monobloc	139.2	53.8	76.7	.98
0859-0012	6V, 8.0Ah Monobloc	139.2	54.1	101.6	1.43



CYCLON® Battery 12 Volt 2x3 Monoblocs

Product Number	Description	Length mm	Width mm	Height mm	Weight kg
0819-0020	12V, 2.5Ah, 2x3	113.8	89.4	70.4	1.04
0809-0020	12V, 5.0Ah, 2x3	139.2	106.2	77.2	1.96
0859-0020	12V, 8.0Ah, 2x3	139.2	106.2	102.1	2.86



CYCLON® Battery 12 Volt 1x6 Monoblocs

Product Number	Description	Length mm	Width mm	Height mm	Weight kg
0819-0016	12V, 2.5Ah, 1x6	224.5	46.0	70.4	1.04
0809-0016	12V, 5.0Ah, 1x6	276.4	53.8	77.2	1.96
0859-0016	12V, 8.0Ah, 1x6	276.4	54.1	102.1	2.86

All dimensions, excluding weight, are maximums

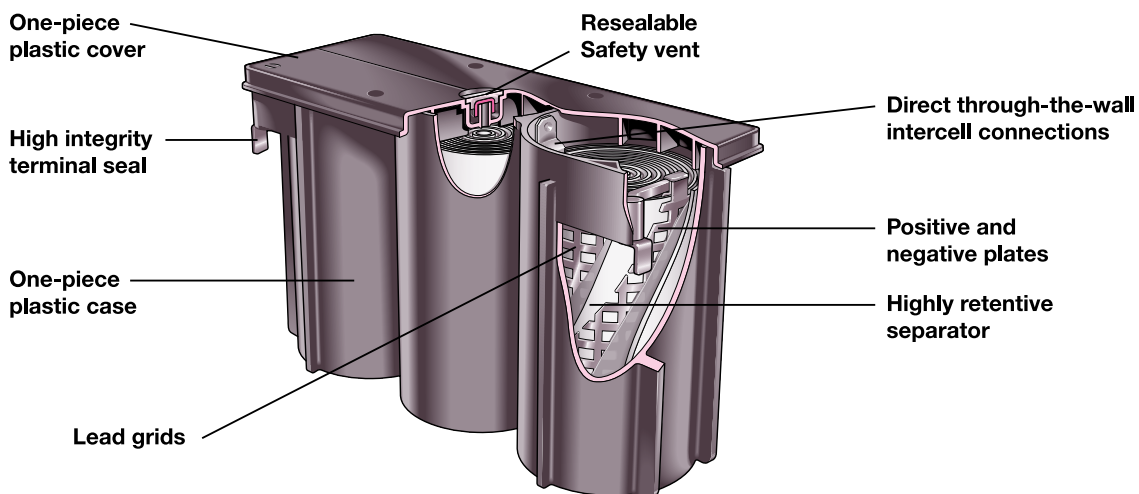

CYCLON® Battery 4V Monobloc mechanical specifications (A, B & C - maximum)

Products	DIMENSIONS					Weight kg	Tabs mm
	A mm	B mm	C mm	D mm	E mm		
D Monobloc	69.9	79.5	46.0	15.5	31.2	.36	4.75x0.64
X Monobloc	76.7	96.5	53.8	18.5	36.8	.74	6.35x0.64
E Monobloc	101.6	96.8	54.1	18.5	36.8	.96	6.35x0.64

CYCLON® Battery 6V Monobloc mechanical specifications (A, B & C - maximum)

Products	DIMENSIONS							Weight kg	Tabs mm
	A mm	B mm	C mm	D mm	E mm	F mm	G mm		
D Monobloc	69.9	113.8	46.0	15.5	31.2	33.8	17.0	.52.187x.025	4.75x0.64
X Monobloc	76.7	139.2	53.8	18.5	36.8	43.4	21.8	.98.250x.025	6.35x0.64
E Monobloc	101.6	139.2	54.1	18.5	36.8	43.4	21.8	1.43.25x.025	6.35x0.64

D Monobloc

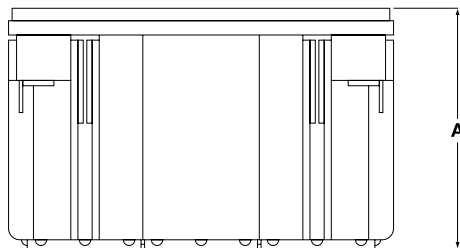

X & E Monobloc

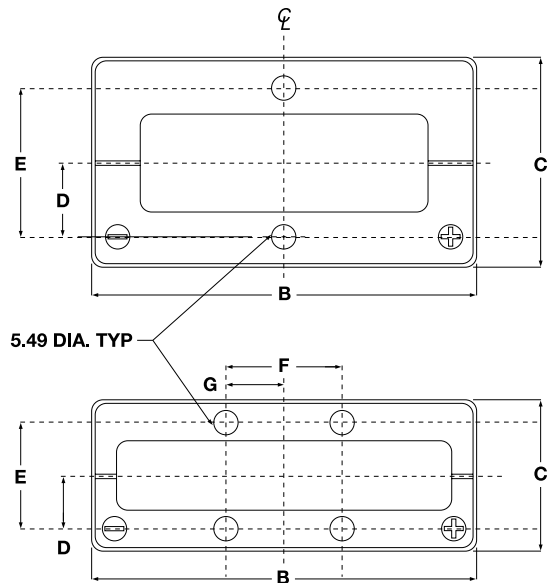
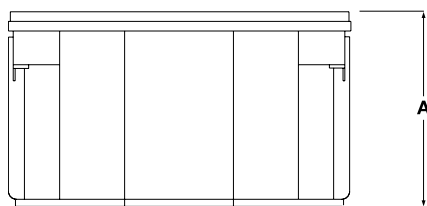

For CYCLON® Battery 4V/6V Monobloc constant current (CC) discharge and constant power (CP) discharge information, please refer to the CYCLON® Application Manual - Appendix A, Figure A-3 and Figure A-4, respectively.

ENERSYS® STANDARD PRODUCT LIST

SINGLE CELL (sc)

PART NUMBER	DESCRIPTION	VOLTAGE	10 Hr RATE	PERFORMANCE SPECIFICATIONS	MECHANICAL SPECIFICATIONS
0810-0004	D Single Cell (Dsc)	2V	2.5Ah	Page 10	Page 13
0860-0004	DT Single Cell (DTsc)	2V	4.5Ah	Page 10	Page 13
0800-0004	X Single Cell (Xsc)	2V	5.0Ah	Page 10	Page 13
0850-0004	E Single Cell (Esc)	2V	8.0Ah	Page 10	Page 13
0840-0004	J Single Cell (Jsc)	2V	12.0Ah	Page 10	Page 13
0820-0004	BC Single Cell (BCsc)	2V	25.0Ah	Page 12	Page 13

SINGLE CELL STANDARD BATTERY DESIGNS

PART NUMBER	DESCRIPTION	VOLTAGE	10 Hr RATE	PERFORMANCE SPECIFICATIONS	MECHANICAL SPECIFICATIONS
0810-0102	1x3 Dsc, double slot, shrink wrap	6V	2.5Ah	Page 10	Page 11
0810-0103	1x3 Dsc, shrink wrap, leads	6V	2.5Ah	Page 10	Page 11
0810-0011	1x3 Dsc, double slot, ABS case	6V	2.5Ah	Page 10	Page 11
0810-0077	1x3 Dsc, single slot, ABS case, leads	6V	2.5Ah	Page 10	Page 11
0860-0102	1x3 DTsc, double slot, shrink wrap	6V	4.5Ah	Page 10	Page 11
0860-0103	1x3 DTsc, shrink wrap, leads	6V	4.5Ah	Page 10	Page 11
0800-0102	1x3 Xsc, double slot, shrink wrap	6V	5.0Ah	Page 10	Page 11
0800-0103	1x3 Xsc, shrink wrap, leads	6V	5.0Ah	Page 10	Page 11
0800-0011	1x3 Xsc, double slot, ABS case	6V	5.0Ah	Page 10	Page 11
0800-0071	1x3 Xsc, single slot, ABS case, leads	6V	5.0Ah	Page 10	Page 11
0850-0102	1x3 Esc, double slot, shrink wrap	6V	8.0Ah	Page 10	Page 11
0850-0103	1x3 Esc, shrink wrap, leads	6V	8.0Ah	Page 10	Page 11
0810-0108	1x6 Dsc, double slot, shrink wrap	12V	2.5Ah	Page 10	Page 11
0810-0109	1x6 Dsc, shrink wrap, leads	12V	2.5Ah	Page 10	Page 11
0810-0016	1x6 Dsc, double slot, ABS case	12V	2.5Ah	Page 10	Page 11
0810-0075	1x6 Dsc, single slot, ABS case, leads	12V	2.5Ah	Page 10	Page 11
0810-0114	2x3 Dsc, double slot, shrink wrap	12V	2.5Ah	Page 10	Page 11
0810-0115	2x3 Dsc, shrink wrap, leads	12V	2.5Ah	Page 10	Page 11
0810-0008	2x3 Dsc, double slot, ABS case	12V	2.5Ah	Page 10	Page 11
0810-0067*	2x3 Dsc, Styrene case, leads	12V	2.5Ah	Page 10	Page 11
0860-0108	1x6 DTsc, double slot, shrink wrap	12V	4.5Ah	Page 10	Page 11
0860-0109	1x6 DTsc, shrink wrap, leads	12V	4.5Ah	Page 10	Page 11
0860-0114	2x3 DTsc, double slot, shrink wrap	12V	4.5Ah	Page 10	Page 11
0860-0115	2x3 DTsc, shrink wrap, leads	12V	4.5Ah	Page 10	Page 11
0800-0108	1x6 Xsc, double slot, shrink wrap	12V	5.0Ah	Page 10	Page 11
0800-0109	1x6 Xsc, shrink wrap, leads	12V	5.0Ah	Page 10	Page 11
0800-0016	1x6 Xsc, double slot, ABS case	12V	5.0Ah	Page 10	Page 11
0800-0072	1x6 Xsc, single slot, ABS case, leads	12V	5.0Ah	Page 10	Page 11
0800-0114	2x3 Xsc, double slot, shrink wrap	12V	5.0Ah	Page 10	Page 11
0800-0115	2x3 Xsc, shrink wrap, leads	12V	5.0Ah	Page 10	Page 11

SINGLE CELL STANDARD BATTERY DESIGNS (continued)

PART NUMBER	DESCRIPTION	VOLTAGE	10 Hr RATE SPECIFICATIONS	PERFORMANCE SPECIFICATIONS	MECHANICAL SPECIFICATIONS
0800-0008	2x3 Xsc, double slot, ABS case	12V	5.0Ah	Page 10	Page 11
0800-0047*	2x3 Xsc, Styrene case, leads	12V	5.0Ah	Page 10	Page 11
0850-0108	1x6 Esc, double slot, shrink wrap	12V	8.0Ah	Page 10	Page 11
0850-0109	1x6 Esc, shrink wrap, leads	12V	8.0Ah	Page 10	Page 11
0850-0114	2x3 Esc, double slot, shrink wrap	12V	8.0Ah	Page 10	Page 11
0850-0115	2x3 Esc, shrink wrap, leads	12V	8.0Ah	Page 10	Page 11
0820-0030	2x3 BCsc, double slot, copper strap	12V	25.0Ah	Page 12	Page 12

MONOBLOC (mb)

PART NUMBER	DESCRIPTION	VOLTAGE	10 Hr RATE	PERFORMANCE SPECIFICATIONS	MECHANICAL SPECIFICATIONS
0819-0010	D Monobloc (Dmb)	4V	2.5Ah	Page 14	Page 16
0809-0010	X Monobloc (Xmb)	4V	5.0Ah	Page 14	Page 16
0859-0010	E Monobloc (Emb)	4V	8.0Ah	Page 14	Page 16
0819-0012	D Monobloc (Dmb)	6V	2.5Ah	Page 14	Page 16
0809-0012	X Monobloc (Xmb)	6V	5.0Ah	Page 14	Page 16
0859-0012	E Monobloc (Emb)	6V	8.0Ah	Page 14	Page 16

MONOBLOC STANDARD BATTERY DESIGNS

PART NUMBER	DESCRIPTION	VOLTAGE	10 Hr RATE	PERFORMANCE SPECIFICATIONS	MECHANICAL SPECIFICATIONS
0819-0016	1x6 Dmb	12V	2.5Ah	Page 14	Page 15
0819-0030	2x3 Dmb	12V	2.5Ah	Page 14	Page 15
0809-0016	1x6 Xmb	12V	5.0Ah	Page 14	Page 15
0809-0030	2x3 Xmb	12V	5.0Ah	Page 14	Page 15
0859-0016	1x6 Emb	12V	8.0Ah	Page 14	Page 15
0859-0030	2x3 Emb	12V	8.0Ah	Page 14	Page 15

CAPACITY RATINGS BASED ON END OF DISCHARGE VOLTAGE OF 1.67 VOLTS/CELL AT 25°C

*Due to special assembly, consult your local EnerSys® Customer Service Department for availability



www.enersys-emea.com

EnerSys
World Headquarters
2366 Bernville Road
Reading, PA 19605
USA
Tel: +1 610 208 1991
+1 800 538 3627
Fax: +1 610 372 8613

EnerSys EMEA
EH Europe GmbH
Löwenstrasse 32
8001 Zürich
Switzerland

EnerSys Asia
152 Beach Road
Gateway East Building
Level 11
189721 Singapore
Tel: +65 6508 1780

Distributed by:

© 2014 EnerSys. All rights reserved.
Trademarks and logos are the property of
EnerSys and its affiliates unless otherwise noted.



Cyclon®

The building blocs providing optimum reliability for customised and specialist battery applications

- Wide temperature operating range (-65°C to +80°C)
- Extremely low self-discharge rate providing up to 2 years shelf-life
- Pure lead design offers highest recharge efficiency
- Very high cycle life delivers up to 300 cycles (100% Depth of Discharge)
- Greatest high-rate power density, per unit weight
- Up to 10-year design life at 25°C*
- Proven in-the-field technology and UL recognised components

*C₅ rate, to 80% of rated capacity



CYCLON® Battery Product Family (All capacities at 10 hr. rate 25°C to 1.67Vpc)

CYCLON® Battery 2V Single Cell:

Products	Capacity	Internal res. of fully charged cell mΩ @ 25°C	Nominal short circuit current for charged cell	DIMENSIONS				
				Diameter mm	Height mm	Height with terminals mm	Weight g	Tabs mm
D cell	2.5Ah	5.0	400A	34.3	61.2	68.1	178.0	4.75x0.64
DT cell	4.5Ah	5.0	400A	34.3	96.0	102.9	274.4	4.75x0.64
X cell	5.0Ah	3.5	570A	44.5	72.9	81.5	362.0	6.35x0.64
E cell	8.0Ah	3.0	665A	44.5	100.1	108.7	489.9	6.35x0.64
J cell	12.0Ah	2.5	800A	51.8	123.2	135.6	839.2	7.92x0.81

CYCLON® Battery 4V Monoblocs:

Products	Capacity	Internal res. of fully charged Monobloc mΩ @ 25°C	Nominal short circuit current for charged cell	DIMENSIONS				
				Diameter mm	Height mm	Height with terminals mm	Weight g	Tabs mm
D cell	2.5Ah	10.0	400A	79.5	46.0	69.9	.36	4.75x0.64
X cell	5.0Ah	7.0	570A	96.5	53.8	76.7	.74	6.35x0.64
E cell	8.0Ah	6.0	665A	96.8	54.1	101.6	.96	6.35x0.64

CYCLON® Battery 6V Monoblocs:

Products	Capacity	Internal res. of fully charged Monobloc mΩ @ 25°C	Nominal short circuit current for charged cell	DIMENSIONS				
				Length mm	Width mm	Height mm	Weight k	Tabs mm
D cell	2.5Ah	15.0	400A	113.8	46.0	69.9	.52	4.75x0.64
X cell	5.0Ah	10.0	570A	139.2	53.8	76.7	.98	6.35x0.64
E cell	8.0Ah	8.0	665A	139.2	54.1	101.6	1.43	6.35x0.64

For the entire range of products available, please see the CYCLON® Selection Guide that is available at www.enersys-emea.com

Alternative battery configurations

Standard battery configurations are rectangular in overall shape.

A sample of other possible configurations are illustrated.

These can be held together with tape (offering the lowest cost and minimum electrical and mechanical protection) or by shrink wrapping. The CYCLON battery Single Cell can be custom configured in virtually an infinite number of designs.

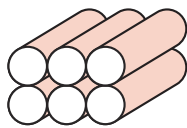

Rectangular

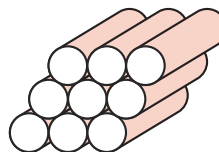

Rhomboid

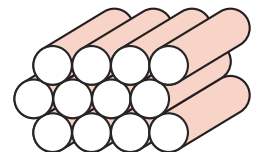

Nested

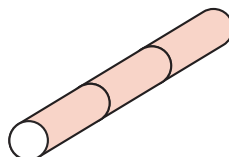

Tubular

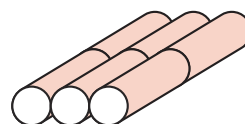

Flat Pack

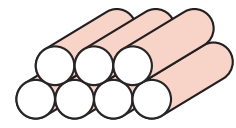

Trapezoid



www.enersys-emea.com

EnerSys
World Headquarters
 2366 Bernville Road
 Reading, PA 19605
 USA
 Tel: +1 610 208 1991
 +1 800 538 3627
 Fax: +1 610 372 8613

EnerSys EMEA
 EH Europe GmbH
 Löwenstrasse 32
 8001 Zürich
 Switzerland

EnerSys Asia
 152 Beach Road
 Gateway East Building
 Level 11
 189721 Singapore
 Tel: +65 6508 1780

Distributed by:

© 2014 EnerSys. All rights reserved.
 Trademarks and logos are the property of EnerSys and its affiliates unless otherwise noted.