

EDLC 2.7V 220F



FEATURES

- Electric double layer capacitor
- Higher power density with ultra low ESR
- Semi-permanent, quick charge and discharge than batteries
- Suitable for short-term peak power assistance application
- UL and ISO/TS certificated, RoHS compliant
- Radial design with 2-pin snap-in terminal type



DIMENSIONS

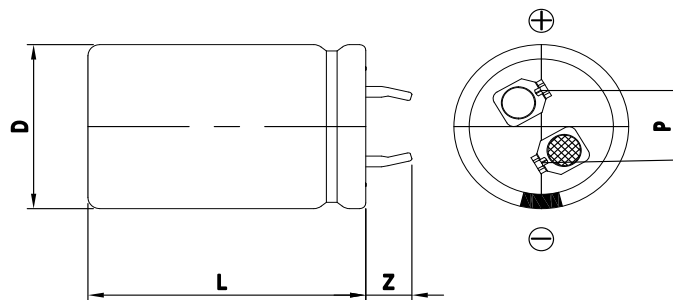

Dimensions in mm			
D +1.5 Max	L ± 2.0	Z ± 1.0	P ± 0.2
Φ25.0	70.0	6.0	10.0

This drawing is not to be scaled.

SPECIFICATIONS

Part Number	Rated Voltage, V_R (V)	Rated Capacitance (F)	AC ESR 1kHz (mΩ)	DC IR (mΩ)	Maximum Current (A)	Leakage Current (mA)	Stored Energy (J)	Dimension D x L (mm)	Weight (g)
VEC 2R7 227 QG	2.7	220.	4.50	7.00	115.	0.440	801.9	25.0 x 70.0	38.0

* Maximum Current: 1 second discharge to $\frac{1}{2} \cdot V_R$

* Leakage Current: After 72hours at V_R and 25 °C

Item	Characteristics	Remarks
Rated Voltage(V_R)	2.7V	
Capacitance Tolerance	-10 ~ 30%	
Operating Temperature ($T_{min} \sim T_{max}$)	-40 ~ +65 °C	$ \Delta cap \leq 30\%$ of initial value at 25 °C $ \Delta ESR \leq 100\%$ of specified value at 25 °C After 1,000 hours application of V_R at T_{max}
Storage Temperature	-40 ~ 70 °C	
Cycle Life	500,000 cycles	$ \Delta cap \leq 30\%$ of initial value at 25 °C $ \Delta ESR \leq 100\%$ of specified value at 25 °C Cycles from V_R to $\frac{1}{2} \cdot V_R$ under constant current at 25 °C
Shelf Life	2 years	$ \Delta cap \leq 10\%$ of initial value at 25 °C $ \Delta ESR \leq 50\%$ of specified value at 25 °C Without electrical charge under T_{max}