



# Dell P2418HT User's Guide

Model: P2418HT  
Regulatory model: P2418HTt



-  **NOTE:** A NOTE indicates important information that helps you make better use of your computer.
-  **CAUTION:** A CAUTION indicates potential damage to hardware or loss of data if instructions are not followed.
-  **WARNING:** A WARNING indicates a potential for property damage, personal injury, or death.

**Copyright © 2017-2019 Dell Inc. All rights reserved.** This product is protected by U.S. and international copyright and intellectual property laws.

Dell™ and the Dell logo are trademarks of Dell Inc. in the United States and/or other jurisdictions. All other marks and names mentioned herein may be trademarks of their respective companies.

# Contents

<b>About Your Monitor</b> .....	<b>5</b>
Package Contents .....	5
Product Features .....	6
Identifying Parts and Controls .....	7
Monitor Specifications .....	10
Plug-and-Play .....	20
LCD Monitor Quality and Pixel Policy .....	20
<b>Setting Up the Monitor</b> .....	<b>21</b>
Routing the Cables .....	21
Attaching the Cable Cover .....	22
Attaching the Stand .....	23
Using the Tilt and Swivel .....	26
Connecting Your Monitor .....	27
Organizing Your Cables .....	28
Removing the Monitor Stand .....	29
Wall Mounting (Optional) .....	30
<b>Operating the Monitor</b> .....	<b>31</b>
Turning on the Monitor .....	31
Using the Front Panel Controls .....	31
Using the On-Screen Display (OSD) Menu .....	34

<b>Troubleshooting</b> . . . . .	<b>47</b>
Self-Test . . . . .	47
Built-in Diagnostics . . . . .	48
Common Problems. . . . .	49
Product Specific Problems . . . . .	51
Touchscreen Problems . . . . .	52
Universal Serial Bus (USB) Specific Problems . . . . .	52
<b>Appendix</b> . . . . .	<b>54</b>
Safety Instructions . . . . .	54
FCC Notices (U.S. only) and Other Regulatory Information . . . . .	54
Contacting Dell . . . . .	54
Setting Up Your Monitor . . . . .	55
Maintenance Guidelines. . . . .	57





# About Your Monitor





---

## Package Contents

Your monitor ships with the components shown below. Make sure that you have received all the components and [contact Dell](#) if something is missing.

 **NOTE:** Some items may be optional and may not ship with your monitor. Some features or media may not be available in certain countries.

	Monitor
	Stand riser
	Stand base
	Cable cover
	Power cable (varies by country)

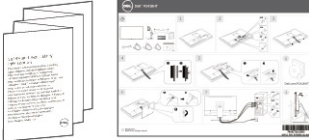
	USB 3.0 upstream cable (enables the USB ports on the monitor)
	DP cable (DP to DP)
	VGA cable
	Cable sleeve
	<ul style="list-style-type: none"> <li>• Quick Setup Guide</li> <li>• Safety, Environmental, and Regulatory Information</li> </ul>

## Product Features

The **Dell P2418HT** monitor has an active matrix, thin film transistor (TFT), liquid crystal display (LCD), and LED backlight. The monitor features include:

- 60.47 cm (23.8-inch) active area display (Measured diagonally) 1920 x 1080 (16:9 aspect ratio) resolution, plus full-screen support for lower resolutions.
- Tilt and swivel adjustment capability.
- Removable pedestal and Video Electronics Standards Association (VESA™) 100 mm mounting holes for flexible mounting solutions.
- Extensive digital connectivity with DP, VGA, HDMI, and USB 3.0 helps future-proof your monitor.
- Plug and play capability if supported by your system.
- Optimize eye comfort with a flicker-free screen and ComfortView feature which minimizes blue light emission.
- On-Screen Display (OSD) adjustments for ease of set-up and screen optimization.
- Security lock slot.
- Supports Asset Management Capability.
- Arsenic-Free glass and Mercury-Free for Panel only.
- Energy Gauge shows the energy level being consumed by the monitor in real time.
- 0.3 W standby power when in the sleep mode.

# Identifying Parts and Controls

## Front view



Label	Description
1	Function buttons (For more information, see <a href="#">Operating the Monitor</a> )
2	Power on/off button (with LED indicator)

## Back View



Label	Description	Use
1	VESA mounting holes (100 mm x 100 mm-behind attached VESA cover)	Wall mount monitor using VESA-compatible wall mount kit (100 mm x 100 mm).
2	Regulatory label	Lists the regulatory approvals.
3	Security lock slot	Secures monitor with security cable lock (sold separately).
4	Stand release button	Release stand from monitor.
5	Barcode, serial number, and Service Tag label	Refer to this label if you need to contact Dell for technical support.
6	Cable hook	Use to route cables.
7	Cable routing label	Shows how to route cables.
8	Cable management slot	Use to organize cables by placing them through the slot.

## Side View





## Bottom View

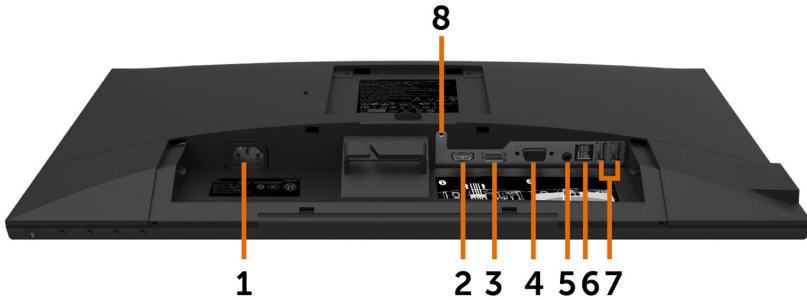

Label	Description	Use
1	AC power connector	To connect the monitor power cable.
2	HDMI connector	Connect your computer with HDMI cable (optional purchase).
3	DP connector	Connect your computer with DP cable.
4	VGA connector	Connect your computer with VGA cable.
5	Audio line-out port	<p>Connect speakers to playback audio coming through HDMI or DP audio channels. Only supports 2-channel audio.</p> <p><b>NOTE:</b> The audio line-out port does not support headphones.</p> <p><b>⚠ WARNING: Excessive sound pressure from earphones or headphones can cause hearing damage or loss.</b></p>
6	USB 3.0 upstream port	Connect the USB cable that comes with your monitor to the computer. Once this cable is connected, you can use the USB downstream connectors on the monitor and the touch screen function on the monitor.
7	USB 2.0 downstream ports	<p>Connect your USB device.</p> <p>You can only use this connector after you have connected the USB cable to the computer and USB upstream connector on the monitor.</p>
8	Stand lock	Lock the stand to the monitor using a M3 x 6 mm screw (screw not included).

# Monitor Specifications

Screen type	Active matrix - TFT LCD
Panel Type	In-plane switching Technology
Aspect ratio	16:9
Viewable image dimensions	
Diagonal	60.47 cm (23.8 inches)
Active Area	
Horizontal	527.04 mm (20.75 inches)
Vertical	296.46 mm (11.67 inches)
Area	156246.2 mm <sup>2</sup> (242.15 inches <sup>2</sup> )
Pixel pitch	0.2745 mm x 0.2745 mm
Pixel per inch (PPI)	93
Viewing angle	
Horizontal	178° (typical)
Vertical	178° (typical)
Brightness	250 cd/m <sup>2</sup> (typical)
Contrast ratio	1000 to 1 (typical)
Dynamic contrast ratio	8,000,000:1
Display screen coating	Anti-glare treatment of the front polarizer (3H) hard coating
Backlight	White LED, EDGELIGHT system
Response Time	6 ms typical (G to G)
Color depth	16.7 million colors
Color gamut	CIE 1976 (84%), CIE 1931 (72%) <b>NOTE:</b> Color gamut is based on CIE 1976 (84%) and CIE 1931 (72%) test standards.
Connectivity	<ul style="list-style-type: none"> <li>• 1 x DP 1.2 (HDCP 1.4)</li> <li>• 1 x VGA</li> <li>• 1 x HDMI 1.4 (HDCP 1.4)</li> <li>• 2 x USB 2.0 downstream port</li> <li>• 1 x USB 3.0 downstream port</li> <li>• 1 x USB 3.0 with BC 1.2 charging capability at 2A (max)</li> <li>• 1 x USB 3.0 upstream port</li> <li>• 1 x Analog 2.0 audio line out (3.5 mm jack)</li> </ul>
Border width (edge of monitor to active area)	5.4 mm (Top) 5.4 mm (Left/Right) 19.51 mm (Bottom)
Adjustability	

Height adjustable stand	0 to 90 mm
Tilt	-5° to 60°
Swivel	-30° to 30°
Pivot	NA
Cable management	Yes
Dell Display Manager (DDM) Compatibility	Easy Arrange and other key features
Security	Security lock slot (cable lock sold separately) Anti-theft stand lock slot (to panel)

## Touch

Type	Projected Capacitive System
Panel Diagonal	23.8 inch
Active Area	
Horizontal	527.04 mm (20.75 inches)
Vertical	296.46 mm (11.67 inches)
Area	156246.2 mm <sup>2</sup> (242.15 inches <sup>2</sup> )
Input Method	Bare finger
Touch point	10 touch-points
Touch response time	35 ms
Touch resolution	4096 x 4096
Touch method	Fingers
Operating system	Windows 10 Certified

## Resolution Specifications

Horizontal scan range	30 kHz to 83 kHz (DP/HDMI/VGA)
Vertical scan range	50 Hz to 76 Hz (DP/HDMI/VGA)
Maximum preset resolution	1920 x 1080 at 60 Hz
Video display capabilities (DP & HDMI & VGA playback)	480i, 480p, 576i, 576p, 720p, 1080i, 1080p

## Preset Display Modes

Display Mode	Horizontal Frequency (kHz)	Vertical Frequency (Hz)	Pixel Clock (MHz)	Sync Polarity (Horizontal/Vertical)
720 x 400	31.5	70.0	28.3	-/+
640 x 480	31.5	60.0	25.2	-/-
640 x 480	37.5	75.0	31.5	-/-
800 x 600	37.9	60.0	40.0	+/+
800 x 600	46.9	75.0	49.5	+/+
1024 x 768	48.4	60.0	65.0	-/-
1024 x 768	60.0	75.0	78.8	+/+
1152 x 864	67.5	75.0	108.0	+/+
1280 x 1024	64.0	60.0	108.0	+/+
1280 x 1024	80.0	75.0	135.0	+/+
1600 x 900	60.0	60.0	108.0	+/-
1920 x 1080	67.5	60.0	148.5	+/+

## Electrical Specifications

Video input signals	<ul style="list-style-type: none"> <li>• Digital video signal for each differential line Per differential line at 100 ohm impedance</li> <li>• DP/HDMI/VGA signal input support</li> </ul>
Input voltage/ frequency/current	100-240 VAC / 50 or 60 Hz $\pm$ 3 Hz / 1.5 A (maximum)
Inrush current	120 V: 40 A (Max.) at 0 °C (cold start) 240 V: 80 A (Max.) at 0 °C (cold start)

## Physical Characteristics

Connector type	<ul style="list-style-type: none"> <li>• DP connector</li> <li>• VGA connector</li> <li>• HDMI connector</li> <li>• Audio line-out</li> <li>• USB 3.0 connector (Port with  battery icon supports BC 1.2.)</li> <li>• USB 2.0 connector</li> </ul>
Signal cable type (in-box)	DP to DP, 1.8 M cable VGA, 1.8 M cable USB 3.0, 1.8 M cable
Dimensions (with stand)	
Height (extended)	419.6 mm (16.52 inches)
Height (compressed)	323.2 mm (12.72 inches)
Width	537.8 mm (21.17 inches)
Depth	234.8 mm (9.24 inches)
Dimensions (without stand)	
Height	321.4 mm (12.65 inches)
Width	537.8 mm (21.17 inches)
Depth	54.1 mm (2.13 inches)
Stand dimensions	
Height (extended)	335.0 mm (13.19 inches)
Height (compressed)	242.7 mm (9.56 inches)
Width	292.0 mm (11.50 inches)
Depth	234.8 mm (9.24 inches)
Weight	
Weight with packaging	9.50 kg (20.94 lb)
Weight with stand assembly and cables	7.42 kg (16.35 lb)
Weight without stand assembly (For wall mount or VESA mount considerations - no cables)	3.12 kg (6.88 lb)
Weight of stand assembly	3.78 kg (8.33 lb)
Front frame gloss	2~4 GU

## Environmental Characteristics

Compliant Standards	
ENERGY STAR certified Monitor	yes
EPEAT	EPEAT registered where applicable. EPEAT registration varies by country. See <a href="http://www.epeat.net">www.epeat.net</a> for registration status by country.
TCO Certified Display	yes
RoHS Compliant	yes
BFR/PVC Free monitor (excluding external cables)	yes
Temperature	
Operating	0 °C to 40 °C (32 °F to 104 °F)
Non-operating	-20 °C to 60 °C (-4 °F to 140 °F)
Humidity	
Operating	10% to 80% (non-condensing)
Non-operating	5% to 90% (non-condensing)
Altitude	
Operating	5,000 m (16,404 ft) (maximum)
Non-operating	12,192 m (40,000 ft) (maximum)
Thermal dissipation	174.02 BTU/hour (maximum) 58.35 BTU/hour (typical)

## Power Management Modes

If you have VESA's DPM-compliant video card or software installed in your PC, the monitor can automatically reduce its power consumption when not in use. This is referred to as power save mode\*. If the computer detects input from the keyboard, mouse, or other input devices, the monitor automatically resumes functioning. The following table shows the power consumption and signaling of this automatic power saving feature.

VESA Modes	Horizontal Sync	Vertical Sync	Video	Power Indicator	Power Consumption
Normal operation	Active	Active	Active	White	51 W (maximum)** 17.1 W (typical)
Active-off mode	Inactive	Inactive	Off	White (Glowing)	Less than 0.3 W
Switch off	-	-	-	Off	Less than 0.3 W

Power Consumption P <sub>on</sub>	13.9 W
Total Energy Consumption (TEC)	50.8 kWh

The OSD operates only in the normal operation mode. If you press any button in the active-off mode, the following message is displayed:

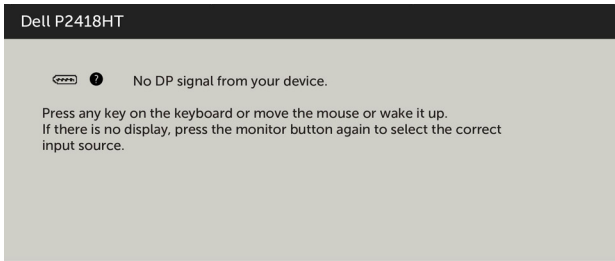

\*Zero power consumption in OFF mode can only be achieved by disconnecting the AC mains cable from the monitor.

\*\*Maximum power consumption with maximum luminance, and USB active.

This document is informational only and reflects laboratory performance. Your product may perform differently, depending on the software, components and peripherals you ordered and shall have no obligation to update such information. Accordingly, the customer should not rely upon this information in making decisions about electrical tolerances or otherwise. No warranty as to accuracy or completeness is expressed or implied.

Activate the computer and the monitor to gain access to the OSD.

 **NOTE:** This monitor is **ENERGY STAR** -certified.



This product qualifies for ENERGY STAR in the factory default settings which can be restored by "Factory Reset" function in the OSD menu. Changing the factory default settings or enabling other features may increase power consumption that could exceed the ENERGY STAR specified limit.

 **NOTE:**

**P<sub>on</sub>**: Power consumption of On Mode as defined in Energy Star 8.0 version.

**TEC**: Total energy consumption in kWh as defined in Energy Star 8.0 version.

# Pin Assignments

## DP connector

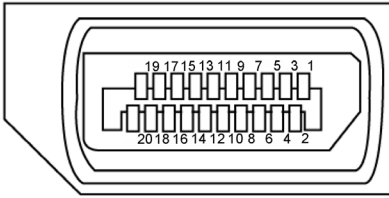

Pin number	20-pin side of the connected signal cable
1	ML3(n)
2	GND
3	ML3(p)
4	ML2(n)
5	GND
6	ML2(p)
7	ML1(u)
8	GND
9	ML1(p)
10	ML0(n)
11	GND
12	ML0(p)
13	CONFIG1
14	CONFIG2
15	AUX CH (p)
16	DP_Cable Detect
17	AUX CH (n)
18	Hot Plug Detect
19	GND
20	+3.3V DP_PWR



## VGA connector

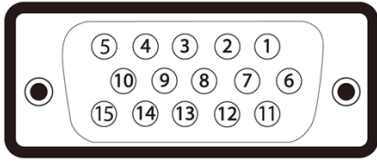

Pin number	15-pin side of the connected signal cable
1	Video-Red
2	Video-Green
3	Video-Blue
4	GND
5	Self-test
6	GND-R
7	GND-G
8	GND-B
9	Computer 5 V / 3.3 V
10	GND-sync
11	GND
12	DDC data
13	H-sync
14	V-sync
15	DDC clock

## HDMI connector

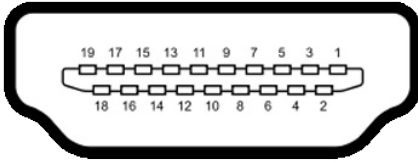

Pin number	19-pin side of the connected signal cable
1	TMDS DATA 2+
2	TMDS DATA 2 SHIELD
3	TMDS DATA 2-
4	TMDS DATA 1+
5	TMDS DATA 1 SHIELD
6	TMDS DATA 1-
7	TMDS DATA 0+
8	TMDS DATA 0 SHIELD
9	TMDS DATA 0-
10	TMDS CLOCK+
11	TMDS CLOCK SHIELD
12	TMDS CLOCK-
13	CEC
14	Reserved (N.C. on device)
15	DDC CLOCK (SCL)
16	DDC DATA (SDA)
17	DDC/CEC Ground
18	+5 V POWER
19	HOT PLUG DETECT

## Universal Serial Bus (USB)

This section gives you information about the USB ports available on your monitor.

**NOTE:** Up to 2 A on USB downstream port (port with  battery icon) with BC 1.2 compliance devices; up to 0.9 A on the other 2 USB downstream ports.

Your computer has the following USB ports:

- 1 USB 3.0 upstream - bottom
- 2 USB 2.0 downstream - bottom
- 2 USB 3.0 downstream - left side

Power Charging Port - the ports with  battery icon supports fast current charging capability if the device is BC 1.2 compatible.

**NOTE:** The monitor's USB ports work only when the monitor is on or in the power save mode. If you turn off the monitor and then turn it on, the attached peripherals may take a few seconds to resume normal functionality.

Transfer speed	Data rate	Power consumption
SuperSpeed	5 Gbps	4.5 W (Max., each port)
Hi-Speed	480 Mbps	2.5 W (Max., each port)
Full speed	12 Mbps	2.5 W (Max., each port)

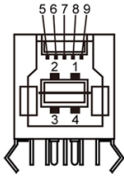
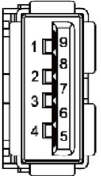
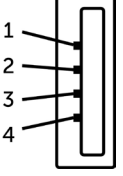
USB 3.0 upstream port		USB 3.0 downstream port		USB 2.0 downstream port	
					
Pin number	Signal name	Pin number	Signal name	Pin number	Signal name
1	VBUS	1	VBUS	1	VCC
2	D-	2	D-	2	DMD
3	D+	3	D+	3	DPD
4	GND	4	GND	4	GND
5	StdB_SSTX-	5	StdA_SSRX-		
6	StdB_SSTX+	6	StdA_SSRX+		
7	GND_DRAIN	7	GND_DRAIN		
8	StdB_SSRX-	8	StdA_SSTX-		
9	StdB_SSRX+	9	StdA_SSTX+		
Shell	Shield	Shell	Shield		

## Plug-and-Play

You can install the monitor in any Plug-and-Play-compatible system. The monitor automatically provides the computer system with its extended display identification data (EDID) using display data channel (DDC) protocols so the computer can configure itself and optimize the monitor settings. Most monitor installations are automatic; you can select different settings if desired. For more information about changing the monitor settings, see [Operating the Monitor](#).

## LCD Monitor Quality and Pixel Policy

During the LCD monitor manufacturing process, it is not uncommon for one or more pixels to become fixed in an unchanging state which are hard to see and do not affect the display quality or usability. For more information on LCD Monitor Pixel Policy, see Dell support site at: <http://www.dell.com/support/monitors>.

# Setting Up the Monitor

---

## Routing the Cables

⚠ CAUTION: Place monitor on a flat, clean, and soft surface to avoid scratching the display panel.

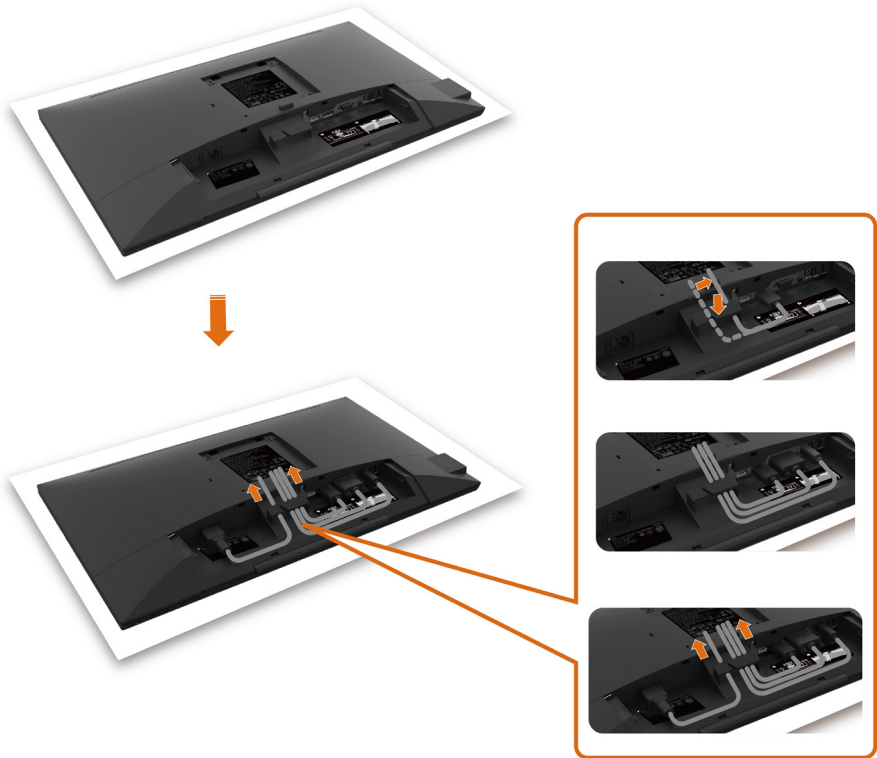

- Remove the monitor protective cover and place the monitor with its front facing downward on it.
- To routing the cables:
  1. Insert DP cable into DP connector (see [Connecting Your Monitor](#)), press the long side of cable hook and push cable to it from top to down.
  2. Repeat step 1 to insert VGA/USB cables into corresponding connector and organize the cables.
  3. Finally, insert and organize the power cable and tighten all the cables as shown above.

## Attaching the Cable Cover

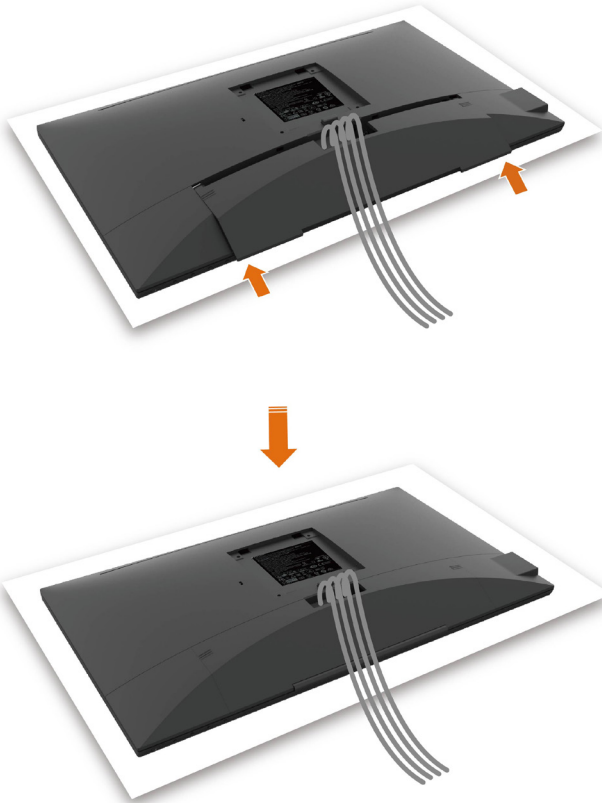

To attach the cable cover:

- Place the cable cover on card slot.
- Follow the direction of arrow and push the cable cover till it snaps into place.

## Attaching the Stand



**NOTE:** The stand riser and stand base are detached when the monitor is shipped from the factory.



**NOTE:** The procedure below is applicable for the default stand. If you purchased any other stand, see the documentation shipped with the stand to set it up.



**CAUTION:** Place monitor on a flat, clean, and soft surface to avoid scratching the display panel.

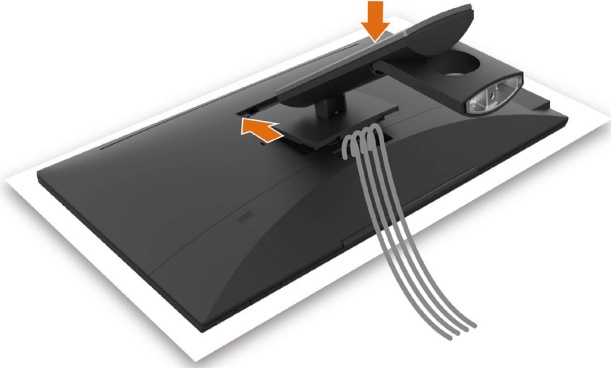

To attach the monitor stand:

- Insert the two tabs on the upper part of the stand to the groove on the back of the monitor.
- Press the stand down till it snaps into its place.



- Hold the stand base with the triangle mark ▲ facing upward.



- Align the stand base protruded blocks to the matching slot on the stand.
- Insert the stand base blocks fully into the stand slot.





- Lift the screw handle and turn the screw clockwise.
- After fully tightening the screw, fold the screw handle flat within the recess.

# Using the Tilt and Swivel

**NOTE:** This is applicable for a monitor with a stand. If you purchased any other stand, refer to the respective stand setup guide for set up instructions.

## Tilt

With the stand attached to the monitor, you can tilt the monitor for the most comfortable viewing angle.

Tilt angle between  $-5^{\circ}$ ~  $+60^{\circ}$ .

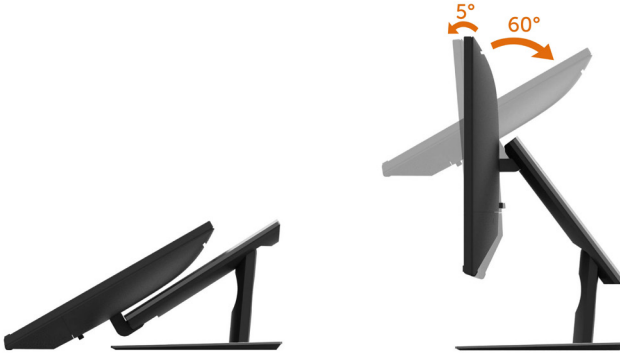

## Swivel

Swivel angle between  $+30^{\circ}$ ~  $-30^{\circ}$ .



**NOTE:** The stand is detached when the monitor is shipped from the factory.

# Connecting Your Monitor

**⚠ WARNING:** Before you begin any of the procedures in this section, follow the [Safety Instructions](#).

To connect your monitor to the computer:

- 1 Turn off your computer.
- 2 Connect the HDMI/DP-DP/VGA/USB cable from your monitor to the computer.
- 3 Switch on your monitor.
- 4 Select the correct input source at Monitor OSD Menu and turn on your computer.

## Single monitor connection

### Connecting the HDMI cable (Optional Purchase)

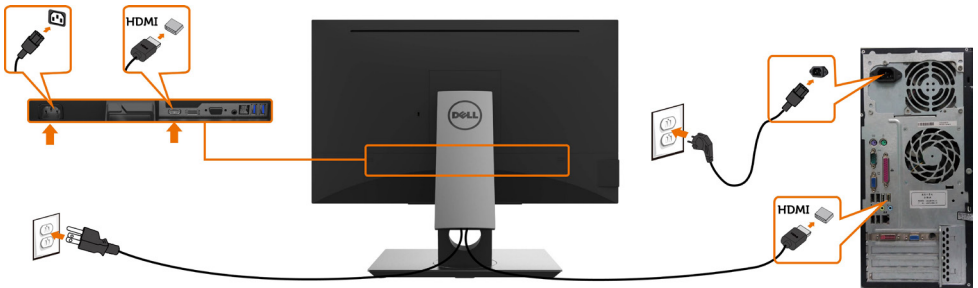

### Connecting the DP (DP to DP) cable

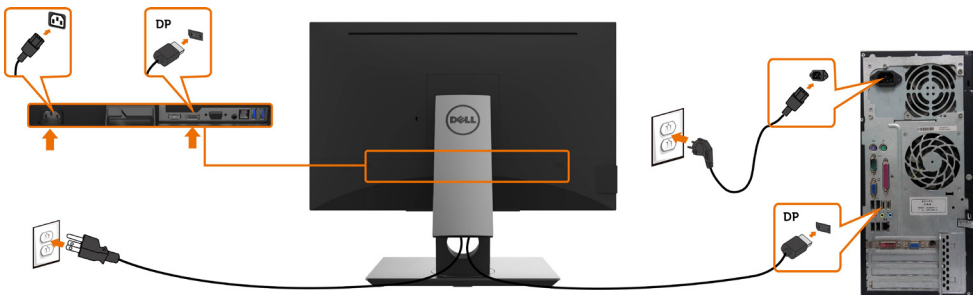

## Connecting the VGA cable

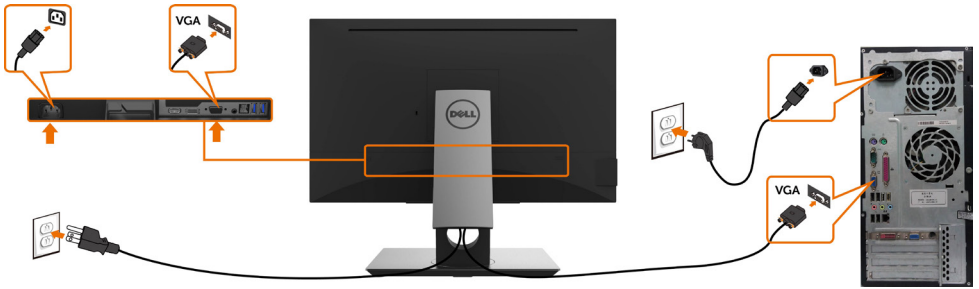

## Connecting the USB cable



## Organizing Your Cables



After attaching all necessary cables to your monitor and computer, (see [Connecting Your Monitor](#) for cable attachment) organize all cables as shown above.

## Removing the Monitor Stand



**CAUTION:** To prevent scratches on the LCD screen while removing the stand, make sure that the monitor is placed on a soft, clean surface.



**NOTE:** The procedure below is applicable for the default stand. If you purchased any other stand, see the documentation shipped with the stand to set it up.

To remove the stand:

- 1 Place the monitor on a soft cloth or cushion.
- 2 Press and hold the stand-release button.
- 3 Lift the stand up and away from the monitor.



## Wall Mounting (Optional)



 **NOTE:** Use M4 x 10 mm screws to connect the monitor to the wall-mounting kit. Refer to the instructions that come with the VESA-compatible wall mounting kit.

- 1 Place the monitor on a soft cloth or cushion on a stable, flat table.
- 2 Remove the stand.
- 3 Use a Phillips crosshead screwdriver to remove the four screws securing the plastic cover.
- 4 Attach the mounting bracket from the wall mounting kit to the monitor.
- 5 Mount the monitor on the wall by following the instructions that comes with the wall mounting kit.

 **NOTE:** For use only with UL or CSA or GS-listed wall mount bracket with minimum weight/load bearing capacity of 3.12 kg (6.88 lb).

# Operating the Monitor

---

## Turning on the Monitor

Press the  button to turn on the monitor.





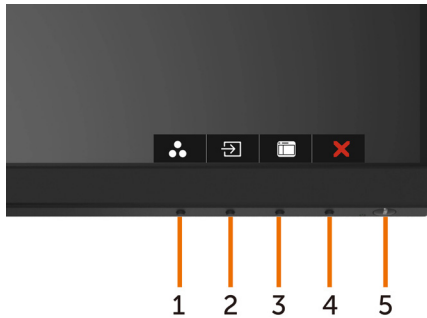

## Using the Front Panel Controls

Use the control buttons on the front of the monitor to adjust the characteristics of the image being displayed. As you use these buttons to adjust the controls, an OSD shows the numeric values of the characteristics as they change.



The following table describes the front panel buttons:





Front-Panel Button	Description
1  Shortcut key: Preset Modes	Use this button to choose from a list of preset color modes.
2  Shortcut key: Input Source	Use this button to choose from a list of Input Source.
3  Menu	Use this menu button to launch the on-screen display (OSD) and select the OSD menu. See <a href="#">Accessing the Menu System</a> .
4  Exit	Use this button to go back to the main menu or exit the OSD main menu.
5  Power (with power light indicator)	Use the <b>Power</b> button to turn the monitor On and Off. The white LED indicates the monitor is On and fully functional. A glowing white LED indicates DPMS Power Save Mode.



# Front-Panel Button

Use the buttons on the front of the monitor to adjust the image settings.



Front Panel Button	Description
1   Up Down	Use the <b>Up</b> (increase) and <b>Down</b> (decrease) keys to adjust items in the OSD menu.
2  OK	Use the <b>OK</b> button to confirm your selection.
3  Back	Use the <b>Back</b> button to go back to the previous menu.









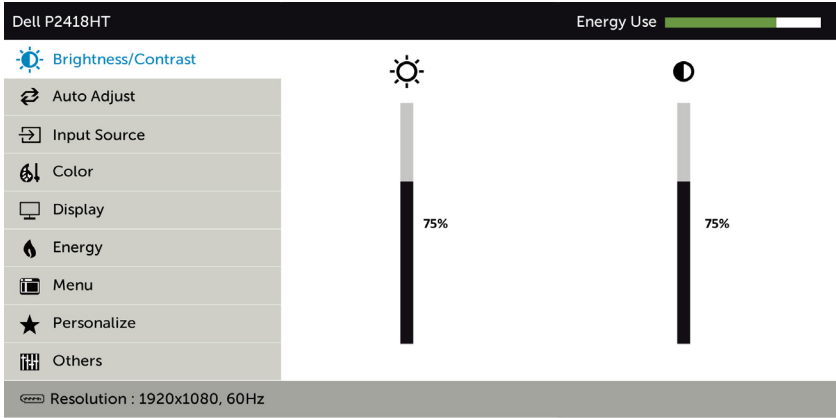



# Using the On-Screen Display (OSD) Menu

## Accessing the Menu System



 **NOTE:** Any changes you make using the OSD menu are automatically saved if you move to another OSD menu, exit the OSD menu, or wait for the OSD menu to disappear.



- 1 Press the  button to launch the OSD menu and display the main menu.

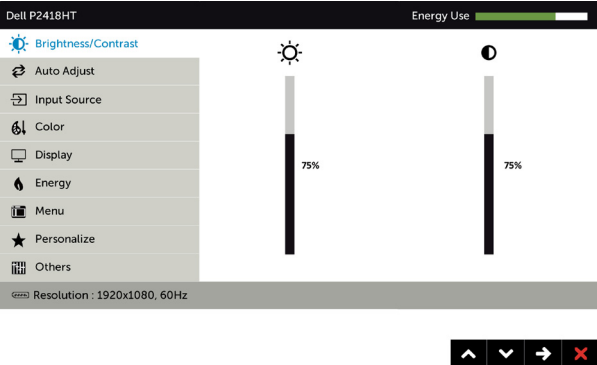



- 2 Press the  and  buttons to move between options. As you move from one icon to another, the option name is highlighted.
- 3 Press the , , or  button once to activate the highlighted option.
- 4 Press the  and  buttons to select the desired parameter.
- 5 Press  to enter the slide bar and then use the  or  button, according to the indicators on the menu, to make your changes.
- 6 Select the  to return to previous menu or  to accept and return to previous menu.

Icon	Menu and Submenus	Description
	<b>Brightness/Contrast</b>	Use this menu to activate <b>Brightness/Contrast</b> adjustment.
		

**Brightness**      **Brightness** adjusts the luminance of the backlight (minimum 0; maximum 100).  
 Press the  button to increase brightness.  
 Press the  button to decrease brightness.  
**NOTE:** Manual adjustment of **Brightness** is disabled when **Dynamic Contrast** is switched on.

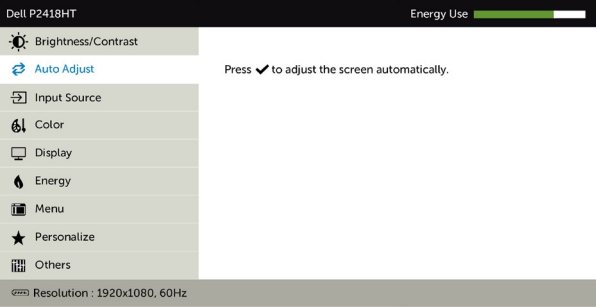
**Contrast**      Adjust the **Brightness** first, and then adjust **Contrast** only if further adjustment is necessary.  
 Press the  button to increase contrast and press the  button to decrease contrast (between 0 and 100).  
 Contrast adjusts the difference between darkness and lightness on the monitor.

Icon	Menu and Submenus	Description
	<b>Auto Adjust</b>	<p>Even though your computer recognizes your monitor on startup, the <b>Auto Adjustment</b> function optimizes the display settings for use with your particular setup.</p> <p><b>Auto Adjustment</b> allows the monitor to self-adjust to the incoming video signal. After using <b>Auto Adjustment</b>, you can further tune your monitor by using the <b>Pixel Clock</b> (Coarse) and <b>Phase</b> (Fine) controls under <b>Display</b> menu.</p>
		
		
<p>The following dialog appears on a black screen as the monitor automatically adjusts to the current input:</p>		
		
<p><b>NOTE:</b> In most cases, <b>Auto Adjust</b> produces the best image for your configuration.</p>		
<p><b>NOTE:</b> <b>Auto Adjust</b> feature option is only available when your monitor is connected using the VGA cable.</p>		

Icon	Menu and Submenus	Description
------	-------------------	-------------



### Input Source

Use the **Input Source** menu to select between different video inputs that are be connected to your monitor.

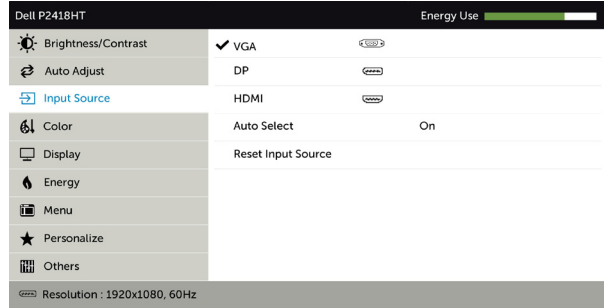

**VGA** Select **VGA** input when you are using the VGA connector. Use to select the VGA input source.

**DP** Select **DP** input when you are using the DP (DisplayPort) connector. Use to select the DP input source.

**HDMI** Select the **HDMI** input when you are using the HDMI connector. Use to select the HDMI input source.

**Auto Select** Use to select **Auto Select**, the monitor scans for available input sources.

**Reset Input Source** Resets your monitor's Input Source settings to the factory defaults.



### Color

Use the **Color** menu to adjust the color setting mode.

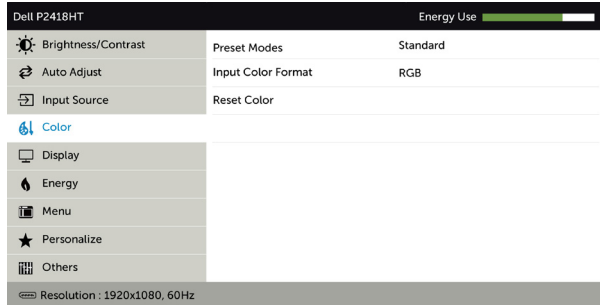

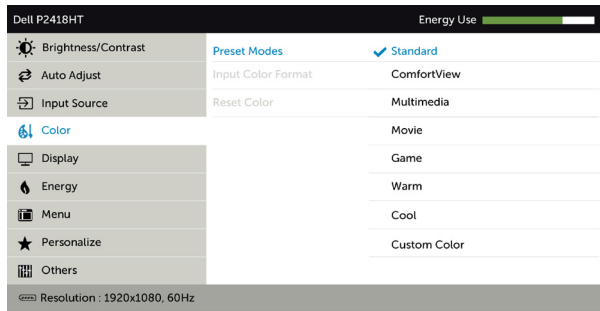

Icon	Menu and Submenus	Description
------	-------------------	-------------

**Preset Modes** When you select **Preset Modes**, you can choose **Standard, ComfortView, Multimedia, Movie, Game, Warm, Cool, or Custom Color** from the list.



- **Standard:** Default color settings. This is the default preset mode.
- **ComfortView:** Decreases the level of blue light emitted from the screen to make viewing more comfortable for your eyes.
- **Multimedia:** Ideal for multimedia applications.
- **Movie:** Ideal for movies.
- **Game:** Ideal for most gaming applications.
- **Warm:** Increases the color temperature. The screen appears warmer with a red/yellow tint.
- **Cool:** Decreases the color temperature. The screen appears cooler with a blue tint.
- **Custom Color:** Allows you to manually adjust the color settings.

Press the  and  buttons to adjust the Red, Green, and Blue values and create your own preset color mode.



Icon	Menu and Submenus	Description
------	-------------------	-------------

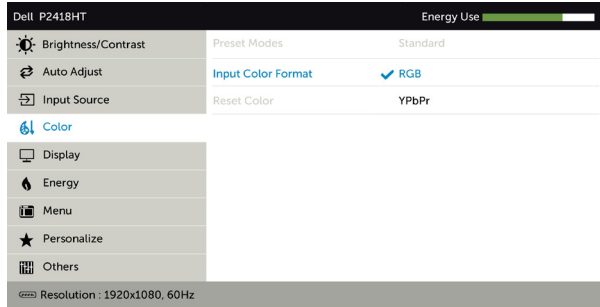

**Input Color Format**

Allows you to set the video input mode to:

- **RGB:** Select this option if your monitor is connected to a computer (or DVD player) using the HDMI, DP-DP or VGA cable.
- **YPbPr:** Select this option if your DVD player supports only YPbPr output.



**Hue** Use  or  to adjust the hue from 0 to 100.  
**NOTE:** Hue adjustment is available only for Movie and Game mode.

**Saturation** Use  or  to adjust the saturation from 0 to 100.  
**NOTE:** Saturation adjustment is available only for Movie and Game mode.

**Reset Color** Resets your monitor's color settings to the factory defaults.

Icon	Menu and Submenus	Description
------	-------------------	-------------



## Display

Use the **Display** menu to adjust image.

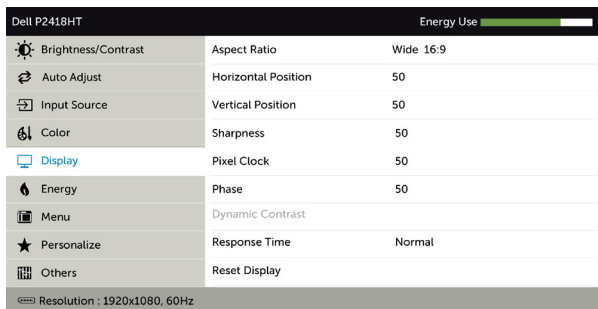

<b>Aspect Ratio</b>	Adjust the image ratio to <b>Wide 16:9</b> , <b>Auto Resize</b> , <b>4:3</b> , or <b>5:4</b> .
<b>Horizontal Position</b>	Use  or  to adjust the image left or right. Minimum is '0' (-). Maximum is '100' (+).
<b>Vertical Position</b>	Use  or  to adjust the image up or down. Minimum is '0' (-). Maximum is '100' (+). <b>NOTE: Horizontal Position and Vertical Position</b> adjustments are only available for "VGA" input.
<b>Sharpness</b>	Makes the image look sharper or softer. Use  or  to adjust the sharpness from '0' to '100'.
<b>Pixel Clock</b>	The <b>Phase</b> and <b>Pixel Clock</b> adjustments allow you to adjust your monitor to your preference. Use the  or  buttons to adjust for best image quality.
<b>Phase</b>	If satisfactory results are not obtained using the <b>Phase</b> adjustment, use the <b>Pixel Clock</b> (coarse) adjustment and then use <b>Phase</b> (fine) again. <b>NOTE: Pixel Clock and Phase</b> adjustments are only available when your monitor is connected using the VGA cable.
<b>Dynamic Contrast</b>	Allows you to increase the level of contrast to provide sharper and more detailed image quality. Push the  button to select the <b>Dynamic Contrast</b> "On" or "Off". <b>NOTE: For Game and Movie</b> preset mode only. <b>NOTE: Dynamic Contrast</b> provides higher contrast if you select <b>Game</b> or <b>Movie</b> preset mode.



Icon	Menu and Submenus	Description
	<b>Response Time</b>	Allows you to set the <b>Response Time</b> to <b>Normal</b> or <b>Fast</b> .
	<b>Reset Display</b>	Restores the display settings to factory defaults.



## Energy

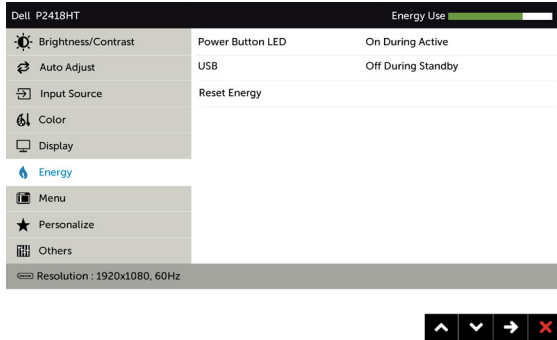

### Power Button LED

Allows you to set the state of the power light to save energy.

### USB

Allows you to enable or disable USB function during monitor standby mode.

**NOTE:** USB ON/OFF under standby mode is only available when the USB upstream cable is unplugged. This option will be greyed out when the USB upstream cable plugs in.

### Reset Energy







Select this option to restore default **Energy** settings.

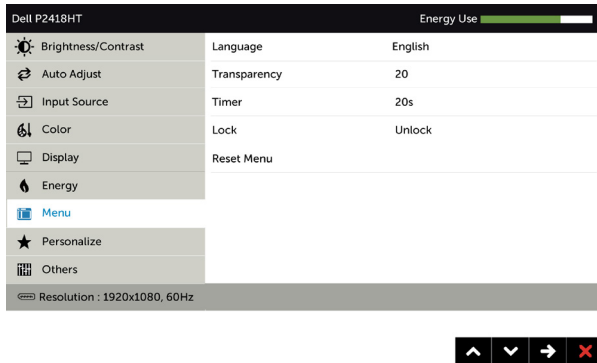

## Menu

Select this option to adjust the settings of the OSD, such as, the languages of the OSD, the amount of time the menu remains on screen, and so on.

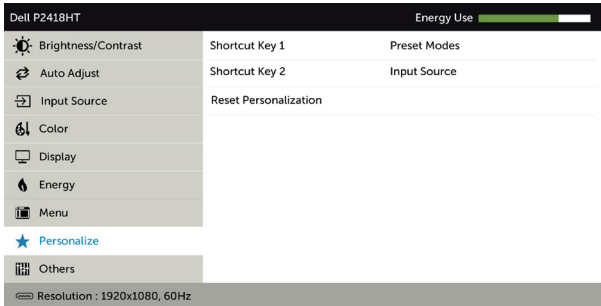

Icon	Menu and Submenus	Description
	<b>Language</b>	Set the OSD display to one of eight languages. (English, Spanish, French, German, Brazilian Portuguese, Russian, Simplified Chinese, or Japanese).
	<b>Transparency</b>	Select this option to change the menu transparency by using  and  (min. 0 / max. 100).
	<b>Timer</b>	<b>OSD Hold Time:</b> Sets the length of time the OSD remains active after you press a button. Use the  and  buttons to adjust the slider in 1-second increments, from 5 to 60 seconds.
	<b>Lock</b>	Controls user access to adjustments. When <b>Lock</b> is selected, no user adjustments are allowed. All buttons are locked. <b>NOTE:</b> <b>Lock</b> function – Either soft lock (through OSD menu) or hard lock (Press and hold the exit button 6 sec) <b>Unlock</b> function – Only hard unlock (Press and hold the exit button 6 sec)
	<b>Reset Menu</b>	Restore the menu settings to factory defaults.
	<b>Personalize</b>	Select from <b>Preset Modes, Brightness/Contrast, Auto Adjust, Input Source</b> or <b>Aspect Ratio</b> and set as shortcut key.  
	<b>Reset Personalization</b>	Restores shortcut keys to factory defaults.

Icon Menu and Submenus

Description



Other

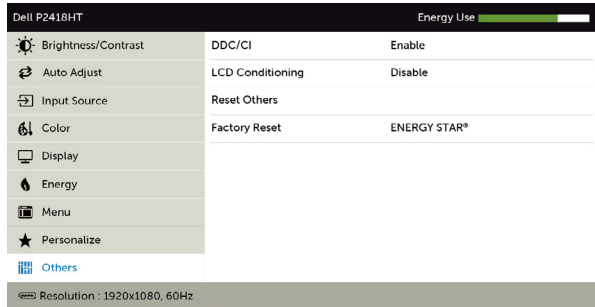

Select this option to adjust the OSD settings, such as the **DDC/CI**, **LCD conditioning**, and so on.

DDC/CI

**DDC/CI** (Display Data Channel/Command Interface) allows you to adjust the monitor settings using software on your computer.

Select **Disable** to turn off this feature.

Enable this feature for best user experience and optimum performance of your monitor.

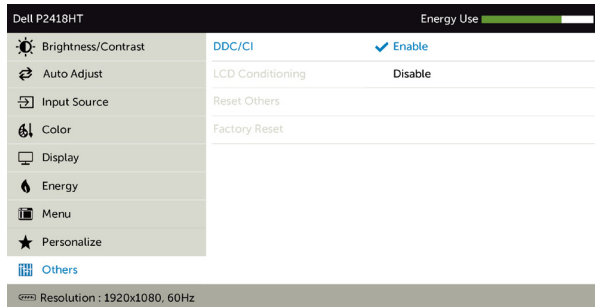

Icon	Menu and Submenus	Description
------	-------------------	-------------

**LCD Conditioning**

Helps reduce minor cases of image retention. Depending on the degree of image retention, the program may take some time to run. Select **Enable** to start the process.

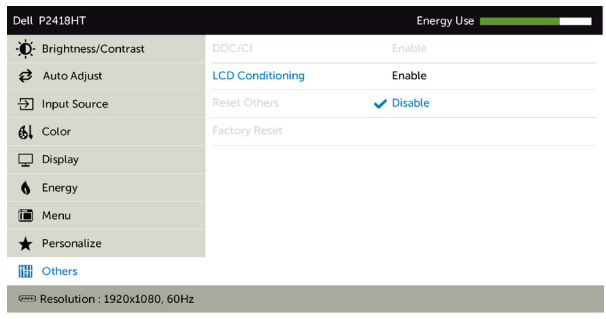

**Reset Others** Restores other settings, such as **DDC/CI**, to factory defaults.

**Factory Reset** Restores all preset values to the factory default settings. These are also the settings for ENERGY STAR® tests.

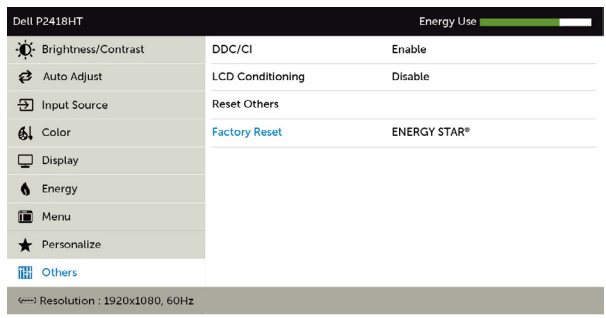

# OSD Warning Messages

When the **Dynamic Contrast** feature is enabled (in these preset modes: **Game** or **Movie**), manual brightness adjustment is disabled.



When the monitor does not support a particular resolution mode, you can see the following message:

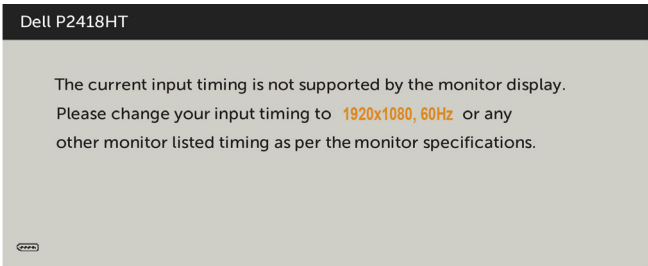

This means that the monitor cannot synchronize with the signal that it is receiving from the computer. See [Monitor Specifications](#) for the Horizontal and Vertical frequency ranges addressable by this monitor. Recommended mode is 1920 x 1080.

You can see the following message before the DDC/CI function is disabled:

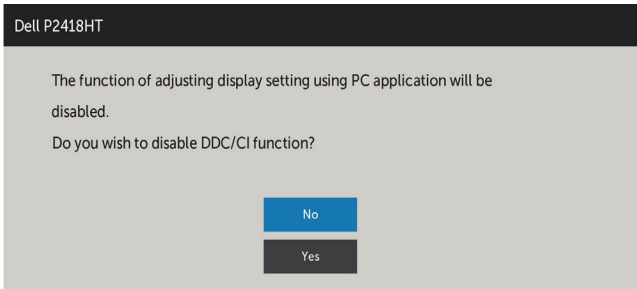

When the monitor enters the **Power Save** mode, the following message appears:



Activate the computer and wake up the monitor to gain access to the [OSD](#).

If you press any button other than the power button, the following messages will appear depending on the selected input:

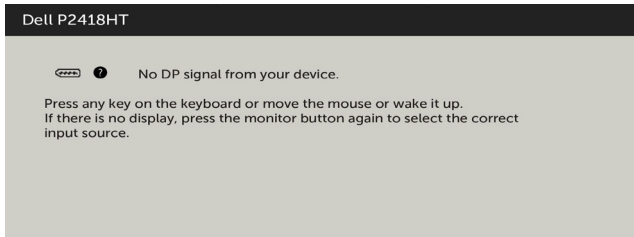

If either DP, VGA, HDMI input is selected and the corresponding cable is not connected, a floating dialog box as shown below appears.

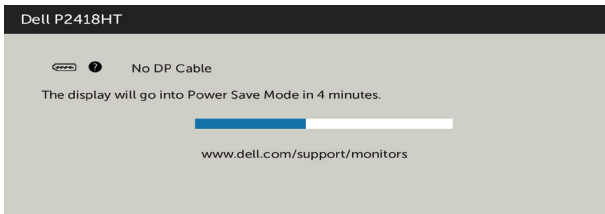

OR

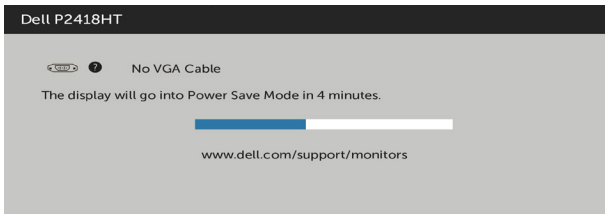

OR

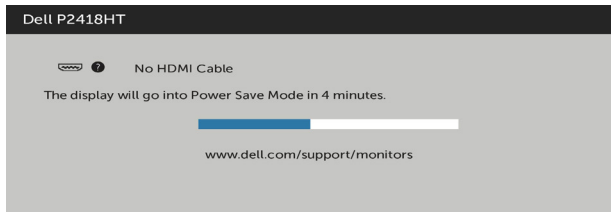

See [Troubleshooting](#) for more information.

# Troubleshooting

---

**⚠ WARNING:** Before you begin any of the procedures in this section, follow the [Safety Instructions](#).

## Self-Test

Your monitor provides a self-test feature that allows you to check whether your monitor is functioning properly. If your monitor and computer are properly connected but the monitor screen remains dark, run the monitor self-test by performing the following steps:

- 1 Turn off both your computer and the monitor.
- 2 Unplug the video cable from the back of the computer. To ensure proper Self-Test operation, remove all digital and the analog cables from the back of computer.
- 3 Turn on the monitor.

The floating dialog box should appear on-screen (against a black background), if the monitor cannot sense a video signal and is working correctly. While in self-test mode, the power LED remains white. Also, depending upon the selected input, one of the dialogs shown below will continuously scroll through the screen.

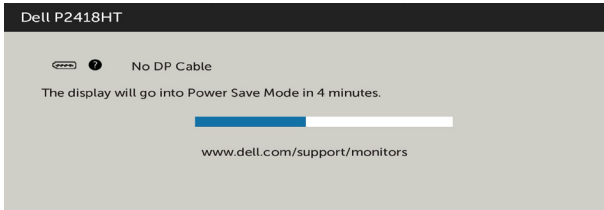

OR

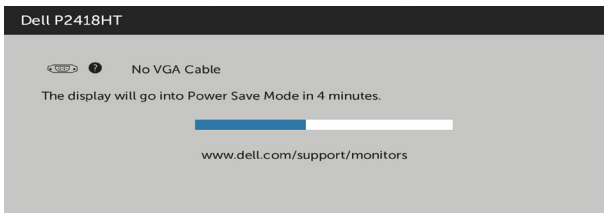

OR

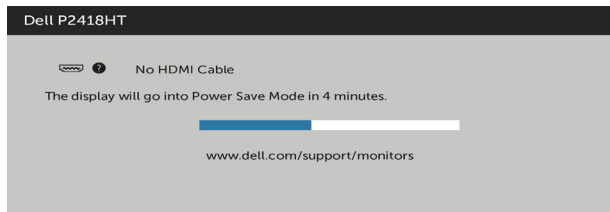

- 4 This box also appears during normal system operation, if the video cable becomes disconnected or damaged.
- 5 Turn off your monitor and reconnect the video cable; then turn on both your computer and the monitor.

If your monitor screen remains blank after you use the previous procedure, check your video controller and computer, because your monitor is functioning properly.

## Built-in Diagnostics

Your monitor has a built-in diagnostic tool that helps you determine if the screen abnormality you are experiencing is an inherent problem with your monitor, or with your computer and video card.

 **NOTE:** You can run the built-in diagnostics only when the video cable is unplugged and the monitor is in self-test mode.



To run the built-in diagnostics:

- 1 Make sure that the screen is clean (no dust particles on the surface of the screen).
- 2 Unplug the video cable(s) from the back of the computer or monitor. The monitor then goes into the self-test mode.
- 3 Press and hold **Button 1** for 5 seconds. A gray screen appears.
- 4 Carefully inspect the screen for abnormalities.
- 5 Press **Button 1** on the front panel again. The color of the screen changes to red.
- 6 Inspect the display for any abnormalities.
- 7 Repeat steps 5 and 6 to inspect the display in green, blue, black, white, and text screens.

The test is complete when the text screen appears. To exit, press **Button 1** again. If you do not detect any screen abnormalities upon using the built-in diagnostic tool, the monitor is functioning properly. Check the video card and computer.



# Common Problems

The following table contains general information about common monitor problems you might encounter and the possible solutions:

Common Symptoms	What You Experience	Possible Solutions
No Video/Power LED off	No picture	<ul style="list-style-type: none"> <li>• Ensure that the video cable connecting the monitor and the computer is properly connected and secure.</li> <li>• Verify that the power outlet is functioning properly using any other electrical equipment.</li> <li>• Ensure that the power button is depressed fully.</li> <li>• Ensure that the correct input source is selected in the <a href="#">Input Source</a> menu.</li> </ul>
No Video/Power LED on	No picture or no brightness	<ul style="list-style-type: none"> <li>• Increase brightness &amp; contrast controls via OSD.</li> <li>• Perform monitor self-test feature check.</li> <li>• Check for bent or broken pins in the video cable connector.</li> <li>• Run the built-in diagnostics.</li> <li>• Ensure that the correct input source is selected in the <a href="#">Input Source</a> menu.</li> </ul>
Poor Focus	Picture is fuzzy, blurry, or ghosting	<ul style="list-style-type: none"> <li>• Perform <b>Auto Adjust</b> via OSD.</li> <li>• Adjust the <b>Phase</b> and <b>Pixel Clock</b> controls via OSD.</li> <li>• Eliminate video extension cables.</li> <li>• Reset the monitor to factory settings.</li> <li>• Change the video resolution to the correct aspect ratio.</li> </ul>
Shaky/Jittery Video	Wavy picture or fine movement	<ul style="list-style-type: none"> <li>• Perform <b>Auto Adjust</b> via OSD.</li> <li>• Adjust the <b>Phase</b> and <b>Pixel Clock</b> controls via OSD.</li> <li>• Reset the monitor to factory settings.</li> <li>• Check environmental factors.</li> <li>• Relocate the monitor and test in another room.</li> </ul>
Missing Pixels	LCD screen has spots	<ul style="list-style-type: none"> <li>• Cycle power on-off.</li> <li>• Pixel that is permanently off is a natural defect that can occur in LCD technology.</li> <li>• For more information on Dell Monitor Quality and Pixel Policy, see Dell Support site at: <a href="http://www.dell.com/support/monitors">http://www.dell.com/support/monitors</a>.</li> </ul>
Stuck-on Pixels	LCD screen has bright spots	<ul style="list-style-type: none"> <li>• Cycle power On-Off.</li> <li>• Pixel that is permanently off is a natural defect that can occur in LCD technology.</li> <li>• For more information on Dell Monitor Quality and Pixel Policy, see Dell Support site at: <a href="http://www.dell.com/support/monitors">http://www.dell.com/support/monitors</a>.</li> </ul>
Brightness Problems	Picture too dim or too bright	<ul style="list-style-type: none"> <li>• Reset the monitor to factory settings.</li> <li>• <b>Auto Adjust</b> via OSD.</li> <li>• Adjust brightness &amp; contrast controls via OSD.</li> </ul>

Common Symptoms	What You Experience	Possible Solutions
Geometric Distortion	Screen not centered correctly	<ul style="list-style-type: none"> <li>Reset the monitor to factory settings.</li> <li>• <b>Auto Adjust</b> via OSD.</li> <li>• Adjust horizontal &amp; vertical controls via OSD.</li> </ul>
Horizontal/ Vertical Lines	Screen has one or more lines	<ul style="list-style-type: none"> <li>Reset the monitor to factory settings.</li> <li>• Perform <b>Auto Adjust</b> via OSD.</li> <li>• Adjust <b>Phase</b> and <b>Pixel Clock</b> controls via OSD.</li> <li>• Perform monitor self-test feature check and determine if these lines are also in self-test mode.</li> <li>• Check for bent or broken pins in the video cable connector.</li> <li>• Run the built-in diagnostics.</li> </ul>
Synchronization Problems	Screen is scrambled or appears torn	<ul style="list-style-type: none"> <li>Reset the monitor to factory settings.</li> <li>• Perform <b>Auto Adjust</b> via OSD.</li> <li>• Adjust <b>Phase</b> and <b>Pixel Clock</b> controls via OSD.</li> <li>• Perform monitor self-test feature check to determine if the scrambled screen appears in self-test mode.</li> <li>• Check for bent or broken pins in the video cable connector.</li> <li>• Restart the computer in safe mode.</li> </ul>
Safety Related Issues	Visible signs of smoke or sparks	<ul style="list-style-type: none"> <li>Do not perform any troubleshooting steps.</li> <li>• Contact Dell immediately.</li> </ul>
Intermittent Problems	Monitor malfunctions on & off	<ul style="list-style-type: none"> <li>Ensure that the video cable connecting the monitor to the computer is connected properly and is secure.</li> <li>• Reset the monitor to factory settings.</li> <li>• Perform monitor self-test feature check to determine if the intermittent problem occurs in self-test mode.</li> </ul>
Missing Color	Picture missing color	<ul style="list-style-type: none"> <li>Perform monitor self-test.</li> <li>• Ensure that the video cable connecting the monitor to the computer is connected properly and is secure.</li> <li>• Check for bent or broken pins in the video cable connector.</li> </ul>
Wrong Color	Picture color not good	<ul style="list-style-type: none"> <li>• Change the settings of the <b>Preset Modes</b> in the <b>Color</b> menu OSD depending on the application.</li> <li>• Adjust R/G/B value under <b>Custom. Color</b> in <b>Color</b> menu OSD.</li> <li>• Change the <b>Input Color Format</b> to PC RGB or YPbPr in the <b>Color</b> menu OSD.</li> <li>• Run the built-in diagnostics.</li> </ul>
Image retention from a static image left on the monitor for a long period of time	Faint shadow from the static image displayed appears on the screen	<ul style="list-style-type: none"> <li>• Use the Power Management feature to turn off the monitor at all times when not in use (for more information, see <a href="#">Power Management Modes</a>).</li> <li>• Alternatively, use a dynamically changing screensaver.</li> </ul>

# Product Specific Problems

Specific Symptoms	What You Experience	Possible Solutions
Screen image is too small	Image is centered on screen, but does not fill entire viewing area	<ul style="list-style-type: none"><li>• Check the <b>Aspect Ratio</b> setting in the <b>Display</b> menu OSD.</li><li>• Reset the monitor to factory settings.</li></ul>
Cannot adjust the monitor with the buttons on the front panel	OSD does not appear on the screen	<ul style="list-style-type: none"><li>• Turn off the monitor, unplug the monitor power cable, plug it back, and then turn on the monitor.</li><li>• Check whether the OSD menu is locked. If yes, press and hold the button beside the power button for 6 seconds to unlock (for more information, see <a href="#">Lock</a>).</li></ul>
No Input Signal when user controls are pressed	No picture, the LED light is white	<ul style="list-style-type: none"><li>• Check the signal source. Ensure the computer is not in the power saving mode by moving the mouse or pressing any key on the keyboard.</li><li>• Check whether the signal cable is plugged in properly. Re-plug the signal cable if necessary.</li><li>• Reset the computer or video player.</li></ul>
The picture does not fill the entire screen	The picture cannot fill the height or width of the screen	<ul style="list-style-type: none"><li>• Due to different video formats (aspect ratio) of DVDs, the monitor may display in full screen.</li><li>• Run the built-in diagnostics.</li></ul>

# Touchscreen Problems

Specific Symptoms	What You Experience	Possible Solutions
Touch report error	Touch function miss alignment or no touch function	<ul style="list-style-type: none"><li>• Use the Dell provided USB cable to connect your computer.</li><li>• Make sure the power cable has a ground pin.</li><li>• Unplug and replug the power cable from the power adapter to allow auto-recalibration of the touch module.</li><li>• Make sure computer supports USB 2.0 or later.</li><li>• If the display cannot be detected by the computer, power off/on the monitor or unplug and replug the USB cable.</li></ul>
Touchscreen non-responsive in power-save mode	Cannot wake up monitor and computer by using touch in power-save mode	<ol style="list-style-type: none"><li>1. Access Device Manager, expand HID Interface Device under Human Device.</li><li>2. Right click HID- compliant device, click Properties and select the check-box to allow the device to wake the computer.</li></ol>
Windows 7, Windows 8, Windows 8.1 and Windows 10 Calibration	Cursor does not accurately follow your finger when you touch the screen	<ol style="list-style-type: none"><li>1. Open Control Panel, open Hardware and Sound, and then open Tablet PC Settings.</li><li>2. Select <b>Calibration</b>.</li><li>3. Follow the instructions to recalibrate your screen</li></ol>

# Universal Serial Bus (USB) Specific Problems

Specific Symptoms	What You Experience	Possible Solutions
USB interface is not working	USB peripherals are not working	<ul style="list-style-type: none"><li>• Check that your monitor is turned ON.</li><li>• Reconnect the upstream cable to your computer.</li><li>• Reconnect the USB peripherals (downstream connector).</li><li>• Switch off and then turn on the monitor again.</li><li>• Reboot the computer.</li><li>• Some USB devices like external portable HDD require higher electric current; connect the device directly to the computer system.</li></ul>

<b>Specific Symptoms</b>	<b>What You Experience</b>	<b>Possible Solutions</b>
SupreSpeed USB 3.0 interface is slow.	SuperSpeed USB 3.0 peripherals working slowly or not working at all	<ul style="list-style-type: none"> <li>• Check that your computer is USB 3.0-capable.</li> <li>• Some computers have USB 3.0, USB 2.0, and USB 1.1 ports. Ensure that the correct USB port is used.</li> <li>• Reconnect the upstream cable to your computer.</li> <li>• Reconnect the USB peripherals (downstream connector).</li> <li>• Reboot the computer.</li> </ul>
Wireless USB peripherals stop working when a USB 3.0 device is plugged in	Wireless USB peripherals responding slowly or only working as the distance between itself and its receiver decreases	<ul style="list-style-type: none"> <li>• Increase the distance between the USB 3.0 peripherals and the wireless USB receiver.</li> <li>• Position your wireless USB receiver as close as possible to the wireless USB peripherals.</li> <li>• Use a USB-extender cable to position the wireless USB receiver as far away as possible from the USB 3.0 port.</li> </ul>

# Appendix

---

## Safety Instructions

For displays with glossy bezels the user should consider the placement of the display as the bezel may cause disturbing reflections from surrounding light and bright surfaces.

 **WARNING: Use of controls, adjustments, or procedures other than those specified in this documentation may result in exposure to shock, electrical hazards, and/or mechanical hazards.**

For information on safety instructions, see the Safety, Environmental, and Regulatory Information (SERI).

## FCC Notices (U.S. only) and Other Regulatory Information

For FCC notices and other regulatory information, see the regulatory compliance website located at [www.dell.com/regulatory\\_compliance](http://www.dell.com/regulatory_compliance).

## Contacting Dell

 **NOTE:** If you do not have an active Internet connection, you can find contact information on your purchase invoice, packing slip, bill, or Dell product catalog.

Dell provides several online and telephone-based support and service options. Availability varies by country and product, and some services may not be available in your area.

### To get online Monitor support content:

See [www.dell.com/support/monitors](http://www.dell.com/support/monitors).

### To contact Dell for sales, technical support, or customer service issues:

- 1 Go to [www.dell.com/support](http://www.dell.com/support).
- 2 Verify your country or region in the Choose A Country/Region drop-down menu at the top-left corner of the page.
- 3 Click **Contact Us** next to the country dropdown.
- 4 Select the appropriate service or support link based on your need.
- 5 Choose the method of contacting Dell that is convenient for you.

# Setting Up Your Monitor

## Setting Display Resolution to 1920 x 1080 (maximum)

For best performance, set the display resolution to 1920 x 1080 pixels by performing the following steps:

### In Windows Vista, Windows 7, Windows 8 or Windows 8.1:

- 1 For Windows 8 or Windows 8.1 only, select the Desktop tile to switch to classic desktop.
- 2 Right-click on the desktop and click **Screen Resolution**.
- 3 Click the Dropdown list of the Screen Resolution and select 1920 x 1080.
- 4 Click **OK**.

### In Windows 10:

- 1 Right-click on the desktop and click **Display Settings**.
- 2 Click **Advanced display settings**.
- 3 Click the dropdown list of **Resolution** and select 1920 x 1080.
- 4 Click **Apply**.

If you do not see the recommended resolution as an option, you may need to update your graphics driver. Please choose the scenario below that best describes the computer system you are using, and follow the given steps.

### Dell computer

- 1 Go to [www.dell.com/support](http://www.dell.com/support), enter your service tag, and download the latest driver for your graphics card.
- 2 After installing the drivers for your graphics adapter, attempt to set the resolution to 1920 x 1080 again.



**NOTE:** If you are unable to set the resolution to 1920 x 1080, please contact Dell to inquire about a graphics adapter that supports these resolutions.

# Non-Dell computer

## In Windows Vista, Windows 7, Windows 8 or Windows 8.1:

- 1 For Windows 8 or Windows 8.1 only, select the Desktop tile to switch to classic desktop.
- 2 Right-click on the desktop and click **Personalization**.
- 3 Click **Change Display Settings**.
- 4 Click **Advanced Settings**.
- 5 Identify your graphics controller supplier from the description at the top of the window (e.g. NVIDIA, ATI, Intel etc.).
- 6 Refer to the graphic card provider website for updated driver (for example, <http://www.ATI.com> or <http://www.NVIDIA.com>).
- 7 After installing the drivers for your graphics adapter, attempt to set the resolution to 1920 x 1080 again.

## In Windows 10:

- 1 Right-click on the desktop and click **Display Settings**.
- 2 Click **Advanced display settings**.
- 3 Click **Display adapter properties**.
- 4 Identify your graphics controller supplier from the description at the top of the window (e.g. NVIDIA, ATI, Intel etc.).
- 5 Refer to the graphic card provider website for updated driver (for example, <http://www.ATI.com> or <http://www.NVIDIA.com>).
- 6 After installing the drivers for your graphics adapter, attempt to set the resolution to 1920 x 1080 again.



**NOTE:** If you are unable to set the recommended resolution, please contact the manufacturer of your computer or consider purchasing a graphics adapter that supports the video resolution.



# Maintenance Guidelines

## Cleaning Your Monitor



**WARNING:** Before cleaning the monitor, unplug the monitor power cable from the electrical outlet.



**CAUTION:** Read and follow the [Safety Instructions](#) before cleaning the monitor.

For best practices, follow these instructions in the list below while unpacking, cleaning, or handling your monitor:

- To clean your anti-static screen, lightly dampen a soft, clean cloth with water. If possible, use a special screen-cleaning tissue or solution suitable for the anti-static coating. Do not use benzene, thinner, ammonia, abrasive cleaners, or compressed air.
- Use a lightly-dampened, soft cloth to clean the monitor. Avoid using detergent of any kind as some detergents leave a milky film on the monitor.
- If you notice white powder when you unpack your monitor, wipe it off with a cloth.
- Handle your monitor with care as a darker-colored monitor may get scratched and show white scuff marks more than a lighter-colored monitor.
- To help maintain the best image quality on your monitor, use a dynamically changing screen saver and turn off your monitor when not in use.