



Vision Turbine meter

Turbine Flow Meters

Vision Series 2000 battery powered

DESCRIPTION

The small turbine meter VISION measurement technology is ideal for the accurate measurement of low viscous and non-aggressive fluids. The VISION 2000 series is most suited for the measurement of flow rates from 0.5 to 35 l/min. The turbine meters can be mounted in any position.

MEASURING PRINCIPLE

Turbine meters are indirect volumetric meters. When the fluid passes through, a rotor is activated and the movement is either electronically or mechanically transmitted outside. The rotor is turned by the fluid force, proportional to the flow rate. A coil detects the passage of the rotor and supplies pulses, which can be utilized for digital or analogue signal processing. The generated pulses are specified as the K-factor. The large number of pulses provides high resolution. As the mass of the turbine is very small the response time is very short. It is not necessary to install a straight length of pipeline at the upstream side of the meter.



SPECIFICATIONS

Type	
	VISION 2006 - COIL VISION 2008 - COIL

Performance	
Flow rate	0.5 – 35 l/min
Accuracy	± 3% of reading
Repeatability	< 0.5% under the same operating conditions
Operating temperature	-20°C to 100°C
Operating pressure rate	max. 25 bar
Burst pressure	200 bar

Pick up					
Pulse sensor	COIL (battery powered)				
Input power	2 – 5.5 V				
Output signal	Push-Pull				
Power consumption	approx. 2.2 µA @ 2V				
K-factor	Version	Material	Nominal size	Flow range	K-factor
	VISION 2008 4F17-COIL	Trogamid CX7323	8 mm	2 – 35 l/min	750 pulse/liter
	VISION 2008 4F22-COIL	Trogamid CX7323	8 mm	1 – 25 l/min	1000 pulse/liter
	VISION 2008 4F44-COIL	Trogamid CX7323	8 mm	1 – 15 l/min	2200 pulse/liter
	VISION 2006 4F44-COIL	Trogamid CX7323	6 mm	1 – 10 l/min	3300 pulse/liter
	VISION 2008 2F66-COIL	Trogamid CX7323	8 mm	0.5 – 7.5 l/min	4700 pulse/liter
	VISION 2006 2F66-COIL	Trogamid CX7323	6 mm	0.5 – 5 l/min	6900 pulse/liter



Material	
Housing	Trogamid CX7323
Rotor	PPS Ferrite bound
Bearings	2 PTFE / Graphite bearings

Fluids	
Viscosity	0.8 – 16 mm ² /sec (mPas/cST)
Fluid type	Liquids
Filter	20 to 40 micron recommended

Installation	
Nominal size DN	6 mm, 8 mm
Mounting position	In any orientation
Electrical connection	3 Pin (2.8 x 0.5) for MINI DIN Connector, EN 60529
IP Protection class (DIN Connector)	IP67
Mechanical connection	Trogamid: G 3/8", NPT 3/8", O-ring, Hose nipple
Tightening torque for screwed connection	approx. 6 Nm

Weight			
	Housing	Connector	Weight
	Trogamid CX7323	DIN	20 g

Approvals		
	Housing	Approvals
	Trogamid CX7323	KTW, NSF/ANSI 61, WRAS, ROHS, CE

PRESSURE DROP

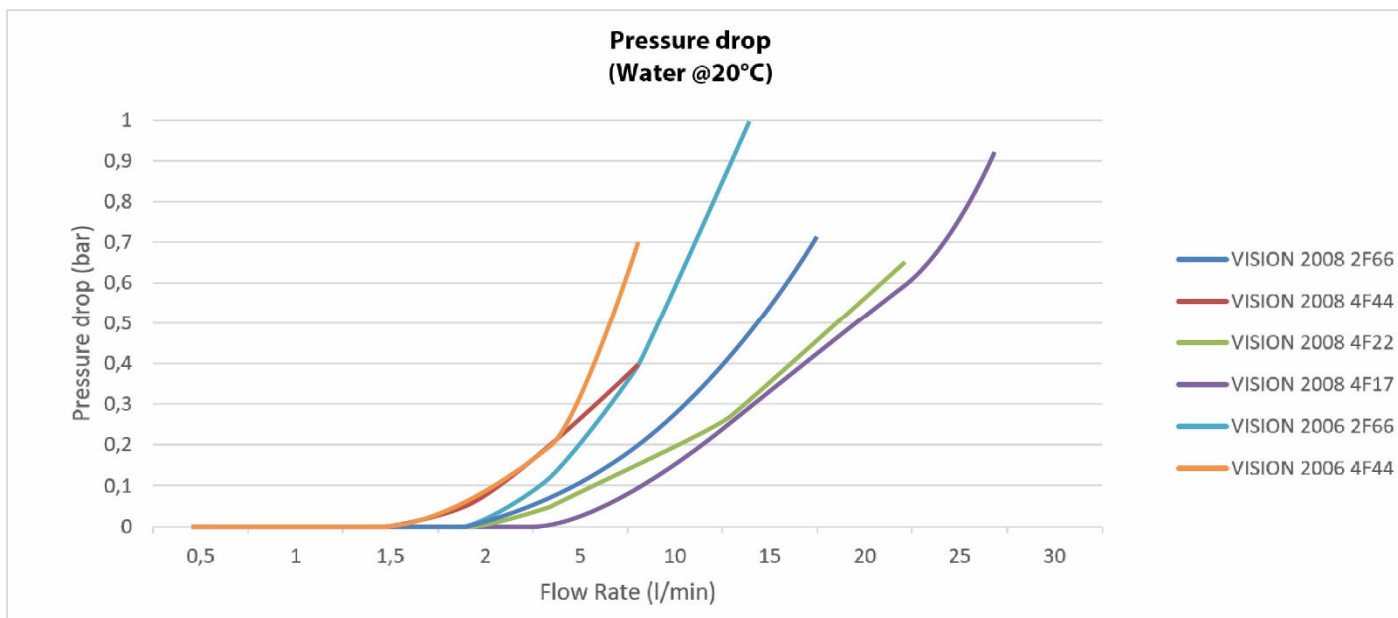

DRAWINGS

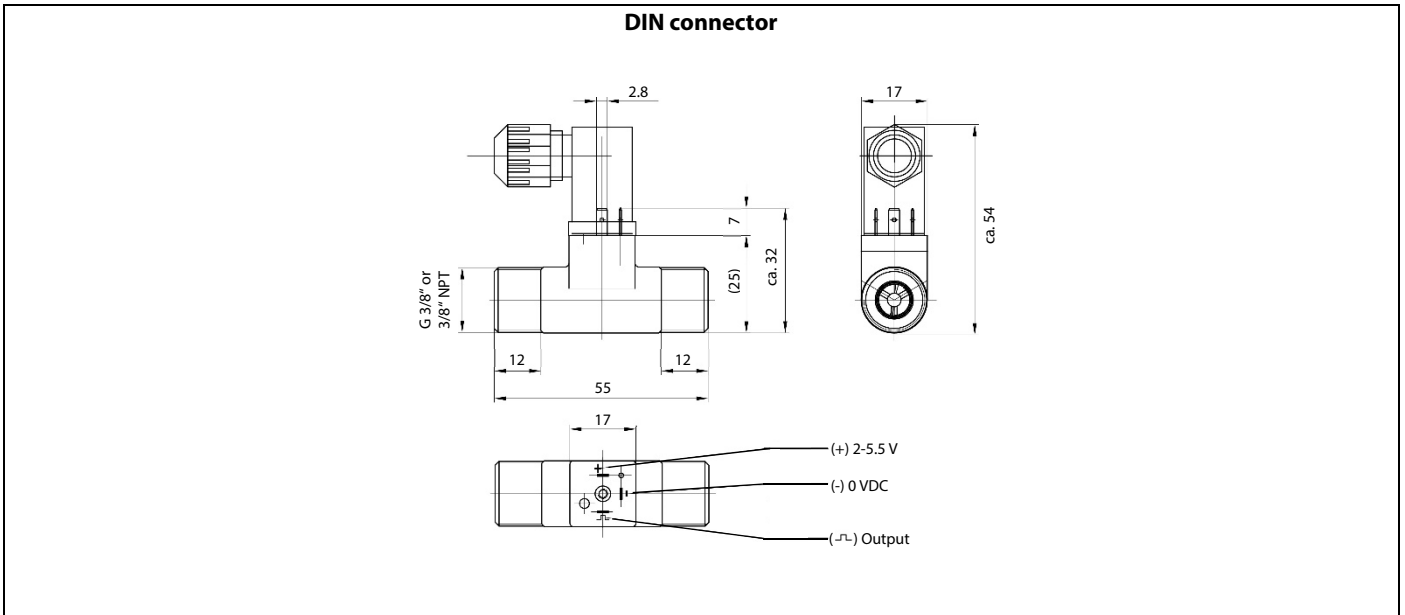



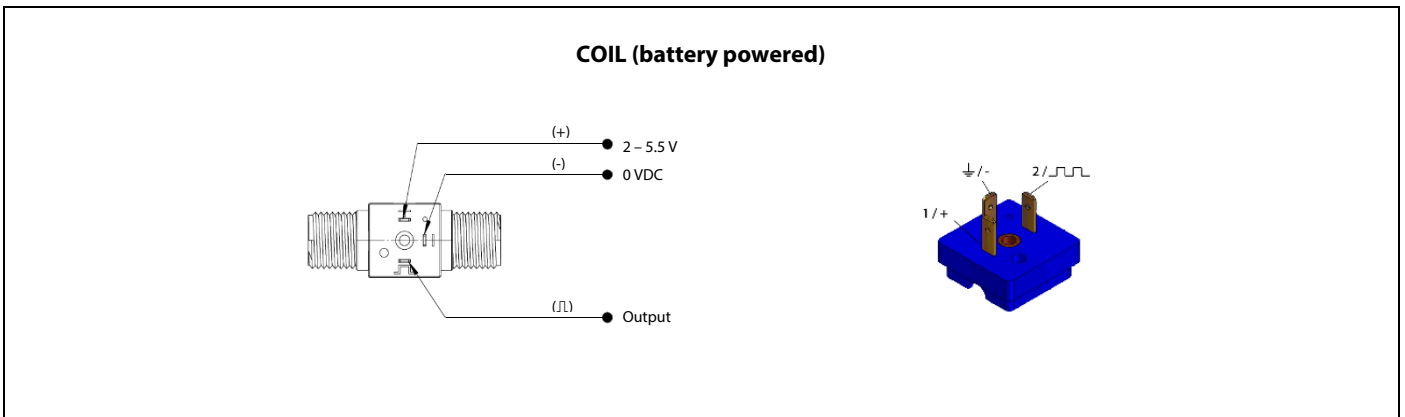



ELECTRICAL WIRING



ORDERING MATRIX - VISION 2000 – COIL + DISPLAY

Select process and electrical connection	Code	
Mechanical connector:		
VISION 2008, G 3/8"	56500	
VISION 2008, NPT 3/8"	56502	
VISION 2008, O-Ring	56520	
VISION 2008, Hose nipple	56138	
VISION 2006, G 3/8"	56510	
VISION 2006, NPT 3/8"	56512	
VISION 2006, O-Ring	56521	
VISION 2006, Hose nipple	56138	
Electrical connection:		
COIL and DIN connector	-166	
Turbine model:		
VISION 2008		-4F17
VISION 2008		-4F22
VISION 2008		-4F44
VISION 2008		-2F66
VISION 2006		-4F44
VISION 2006		-2F66
Available displays see below		Display option

Ordering code displays:		Code
Remote mounted ILR-701T display (3 m cable) / Total / Flow rate <u>Example</u> shows display with turbine meter		-56703
Remote mounted ILR-750T display (3 m cable) / Total / Flow rate / 4-20 mA output <u>Example</u> shows display with turbine meter		-56704
RF-Display ILR 701T (transmitter + receiver) / Total	 Receiver  Transmitter	-56700

Meter mounted ILR-701T display / Total / Flow rate (Display including bracket)		-56707
Meter mounted ILR-750T display / Total / Flow rate / 4.20mA output (Display including bracket)		-56705

Examples:	Code			
VISION 2008 2F66 - COIL G3/8"	56500	-166	-2F66	
VISION 2008 4F17 - COIL G3/8" with ILR701T remote (3m cable)	56500	-166	-4F17	-56703
VISION 2008 4F22 - COIL O-ring with ILR750T metermount	56520	-166	-4F22	-56705
VISION 2006 2F66 - COIL G3/8"	56510	-166	-2F66	
VISION 2006 4F44 - COIL G3/8" with ILR701T remote (3m cable)	56510	-166	-4F44	-56703
VISION 2006 4F44 - COIL O-Ring with ILR750T metermount	56521	-166	-4F44	-56705

DISPLAYS

Technical Data ILR 701T	
Display flow	Actual flow: 6 digits
	Total flow: 11 digits, non-resettable 6 digits, resettable
Output	Analog output: /
	Pulse output: /
Display units	Liter, Pints, Quarts, Gallons
Input	Coil
Pulse input scale	0,5000 – 2,0000
Temperature	-20 °C to + 80 °C
Linearization (Optional)	9 points
Protection class	IP 67
Internal power supply	Battery CR123A Lithium, 3 VDC
Remote mount	Installation: Available with 3 m cable or as RF Display
	Weight: 230 g
Meter mount	Installation: Including bracket for the VISION turbine meter
	Weight: 155 g

Technical Data ILR 750T	
Display flow	Actual flow: 6 digits
	Total flow: 11 digits, non-resettable 6 digits, resettable
Output	Analog output: 4-20 mA
	Pulse output: Scalable
Display units	Liter, Pints, Quarts, Gallons
Input	Coil
Pulse input scale	0.5000 – 2.0000
Temperature	-20 °C to + 80 °C
Linearization (Optional)	9 points
Protection class	IP 67
Internal power supply	Battery CR123A Lithium, 3 VDC
Remote mount	Installation: Available with 3 m cable
	Weight: 340 g
Meter mount	Installation: Including bracket for the VISION turbine meter
	Weight: 275 g

Technical Data RF ILR 701T	
Display flow	Actual flow: /
	Total flow: 11 digits, non-resettable 6 digits, resettable
Output	Analog output: /
	Pulse output: /
Display units	Liter, Pints, Quarts, Gallons
Input	Coil
Pulse input scale	0.5000 – 2.0000
Temperature	-20 °C to + 80 °C
Linearization (Optional)	9 points
Protection class	IP 67
Internal power supply	Battery CR123A Lithium, 3 VDC (Transmitter, Receiver/Display)
RF frequency	2.4 GHz ISM
Radio range	5 to 6 m
Receiver / Display	LCD Display with wall mounting bracket
Transmitter	Transmitter: Electronic board, battery powered CR123A Lithium, 3 VDC
	Installation: Will be mounted directly onto the VISION turbine meter
Remote mount	Installation: RF Display
	Weight: 210 g