

Datasheet

Item no. 1619012 / 1618956 / 1618971

0.30" Dual Digit Numeric Displays Common Anode

Package Dimension:

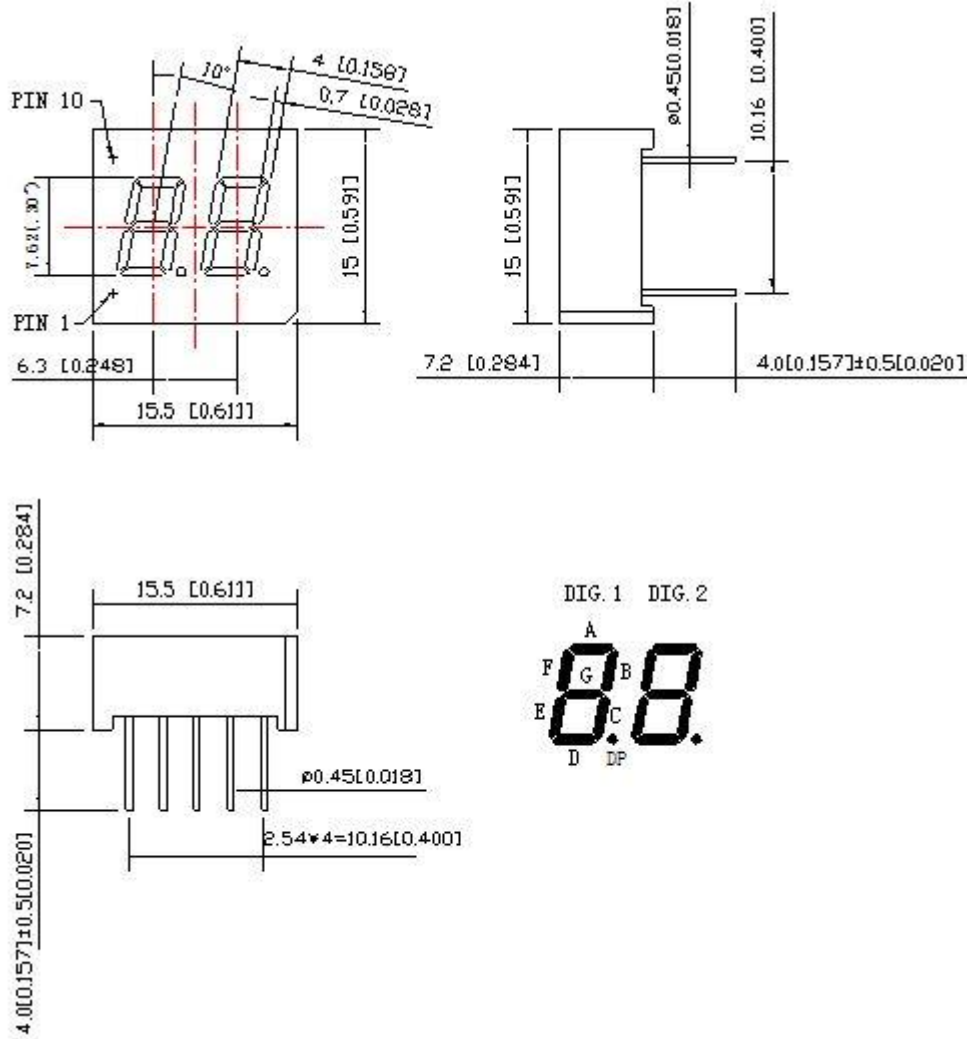

Common Anode

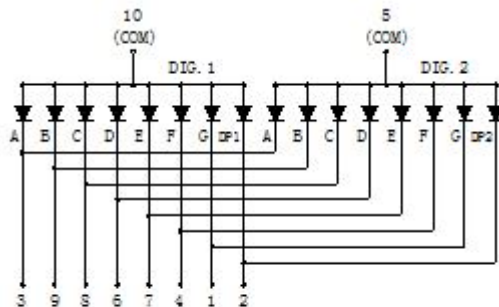

Notes:

All dimensions are in millimeters (inches).
 Tolerance is ± 0.25 mm (.010") unless otherwise noted.
 Specifications are subject to change without notice.

Datasheet

Item no. 1619012 / 1618956 / 1618971

Absolute Maximum Ratings at Ta=25°C

Parameters	Symbol	Max.	Unit
Power Dissipation Per Segment	PD	60	mW
Peak Forward Current Per Segment (1/10 Duty Cycle, 0.1ms Pulse Width)	IFP	100	mA
Forward Current Per Segment	IF	25	mA
Dating Linear From 50°C		0.4	mA/°C
Reverse Voltage	VR	5	V
Operating Temperature Range	Topr	-40°C to +80°C	
Storage Temperature Range	Tstg	-40°C to +85°C	
Soldering Temperature	Tsld	260°C for 5 Seconds	

Electrical Optical Characteristics at Ta=25°C

Source Color	Model No.	VF(V)			IR(μA)			IV(mcd)			λd(nm)		
		Min.	Typ.	Max.				Min.	Typ.	Max.	Min.	Typ.	Max.
		IF=20mA			VR=5V			IF=20mA					
Red	TRU-7S2-30RAG	2.0	2.6	50	5	10	--	640	650	660			
Yellow Green	TRU-7S2-30GAG	2.1	2.7	50	8	16	--	568	572	575			
Blue	TRU-7S2-30BAG	3.2	3.8	50	7.5	15	--	460	467	475			
White		3.2	3.6	50	15	30	--	X=0.30	Y=0.31				

Notes:

Luminous intensity is measured with a light sensor and filter combination that approximates the CIE eye-response curve.

The dominant wavelength (λd) is derived from the CIE chromaticity diagram and represents the single wavelength which defines the color of the device.