



TILTIX Inclinometer

ACS-040-2-SV40-HK2-2W

POSITAL
FRABA



General Specifications

Application	2-Axes Position Monitoring and Leveling
Measurement Range	$\pm 40^\circ$
Absolute Accuracy	0.10°
Resolution	0.01°

Electrical Specifications

Supply Voltage	10 - 30 VDC
Power Consumption (no load)	≤ 0.7 W
EMC: Emitted Interference	DIN EN 61000-6-4
EMC: Noise Immunity	DIN EN 61000-6-2
Reverse Polarity Protection	Yes
Short Circuit Protection	Yes

Environmental Specifications

Operating Temperature	-40 °C (-40 °F) - +80 °C (+176 °F)
Storage Temperature	-40 °C (-40 °F) - +85 °C (+185 °F)
Temperature Gradient	0.004°/ K
Protection Class	IP68/IP69K
Shock Resistance	≤ 100 g (half sine 6 ms, EN 60068-2-27)
Vibration Resistance	1.5 mm (10 Hz - 58 Hz) & ≤ 20 g (58 Hz to 2000 Hz)

Data Sheet

Printed at 27-09-2017 12:09

POSITAL

FRABA



Mechanical Specifications

Housing Material	Die-Cast Aluminum Alloy
Potting Material	PUR (Polyurethane)
Weight	520 g (1.15 lb)

Certificates / Lifetime

MTTF	400 years @ 40 °C
Certificates	CE

Interface

Interface	Analog Voltage 0.5-9.5 V + RS232
Teach In	Zero Positioning, Inverse Direction, Elevation Range Programming
Settling Time	125 ms
Output Type	Voltage 0.5 - 9.5 V
Min Load Resistance	5 kΩ
Transmission Rate	RS232: min. 1200 Baud; max. 115200 Baud
Default Transmission Rate	RS232: 9600 Baud
Linearity	± 0.02%

POSITAL

FRABA

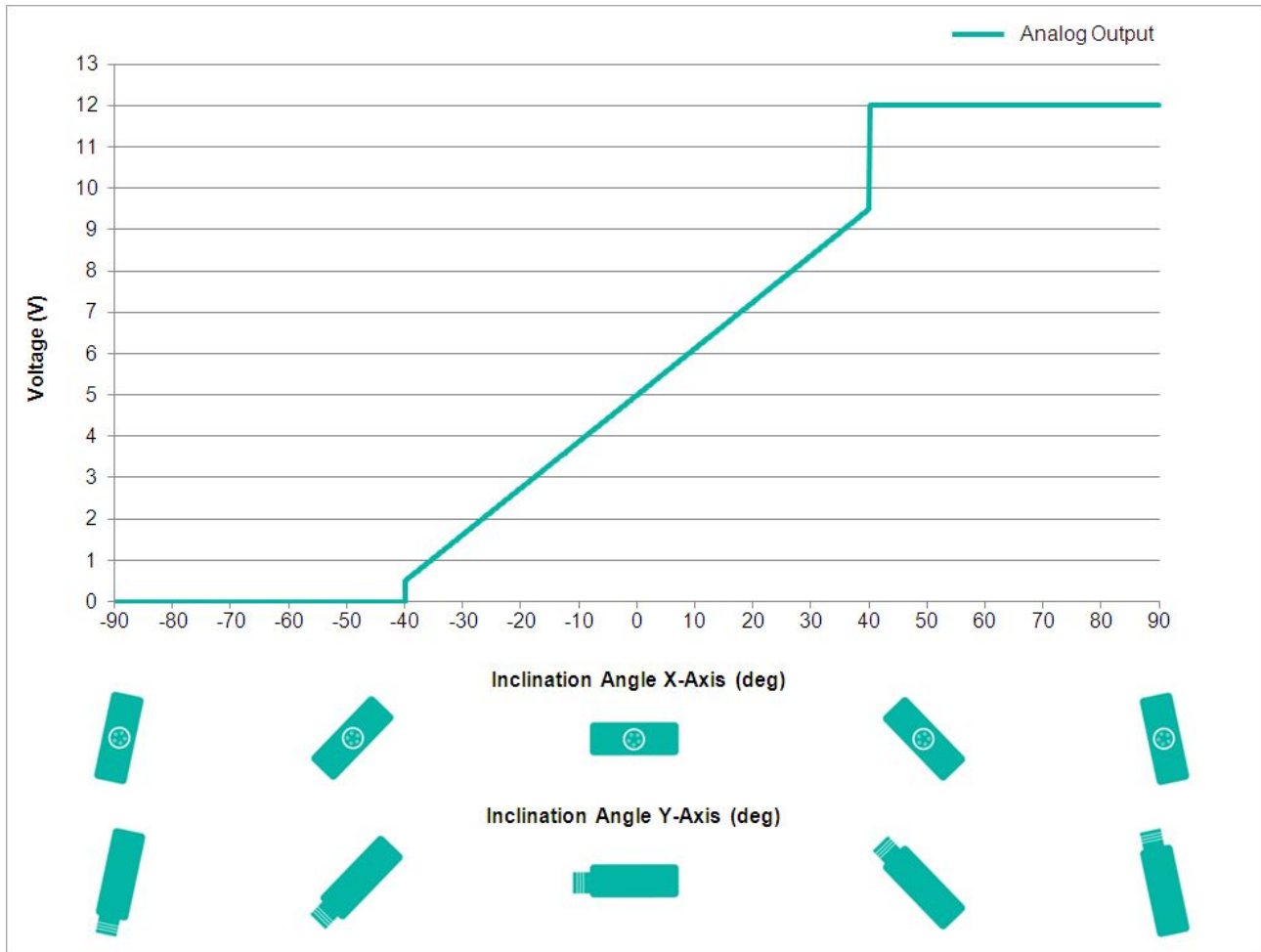

Electrical Connection

Connection Type	Cable 2 m
Cable Length	2 m [79"]
Wire Cross Section	0.34 mm ² / AWG 22
Material / Type	PUR / PU
Cable Diameter	7.5 mm (0.30 in)
Minimum Bend Radius	56 mm (2.2") fixed, 75 mm (3") flexing

Product Life Cycle

Product Life Cycle	Established
--------------------	-------------

Connection Plan

SIGNAL	CABLE COLOR
Power Supply	Red

Data Sheet

Printed at 27-09-2017 12:09

POSITAL

FRABA



GND	Yellow
X-Axis, Voltage Output	Green
Y-Axis, Voltage Output	Blue
RxD	Gray
TxD	Pink
Set1	Brown
Set2	White
Shielding	Shield

Dimensional Drawing

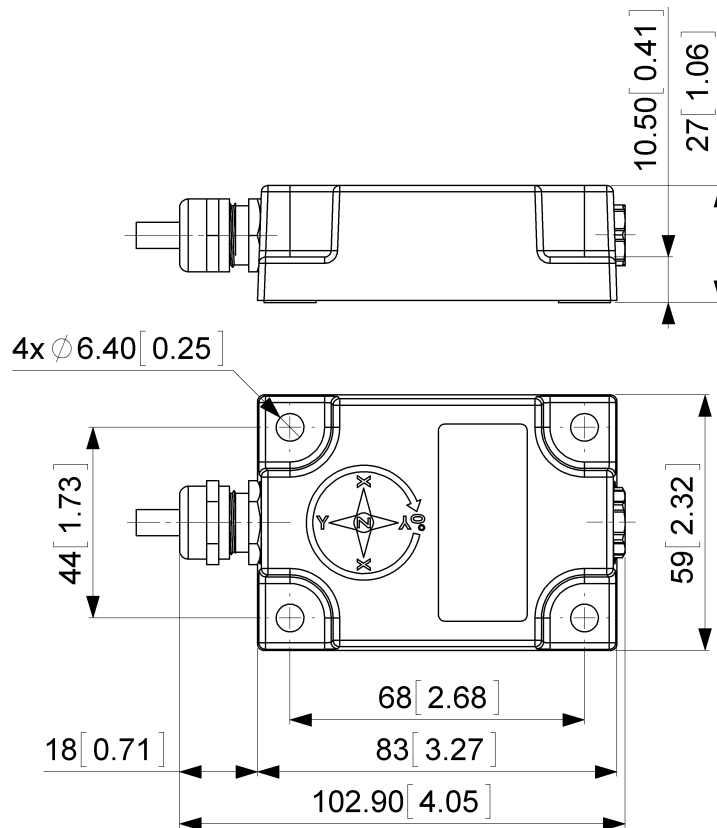

[2D Drawing](#)

Accessories

Contact

Data Sheet
Printed at 27-09-2017 12:09

POSITAL

FRABA



POSITAL
Contact Us

All dimension in [inch] mm. This drawing and the information contained is for general presentation purposes only. Please refer to the "Download" section for detailed technical drawings. © FRABA B.V., All rights reserved. We do not assume responsibility for technical inaccuracies or omissions. Specifications are subject to change without notice.