



TILTIX Inclinometer

ACS-060-2-SC00-HE2-PM

POSITAL
FRABA



General Specifications

Application	2-Axes Position Monitoring and Leveling
Measurement Range	$\pm 60^\circ$
Absolute Accuracy	0.10°
Resolution	0.01°

Electrical Specifications

Supply Voltage	10 - 30 VDC (See also Interface: Max Load Resistance)
Power Consumption (no load)	$\leq 0.7 \text{ W}$
EMC: Emitted Interference	DIN EN 61000-6-4
EMC: Noise Immunity	DIN EN 61000-6-2
Reverse Polarity Protection	Yes
Short Circuit Protection	Yes

Environmental Specifications

Operating Temperature	$-40^\circ\text{C} (-40^\circ\text{F}) - +85^\circ\text{C} (+185^\circ\text{F})$
Storage Temperature	$-40^\circ\text{C} (-40^\circ\text{F}) - +85^\circ\text{C} (+185^\circ\text{F})$
Temperature Gradient	$0.004^\circ/\text{K}$
Protection Class	IP66/IP67
Shock Resistance	$\leq 100 \text{ g}$ (half sine 6 ms, EN 60068-2-27)
Vibration Resistance	1.5 mm (10 Hz - 58 Hz) & $\leq 20 \text{ g}$ (58 Hz to 2000 Hz)

Data Sheet

Printed at 27-09-2017 12:09

POSITAL

FRABA



Mechanical Specifications

Housing Material	Fibre-Reinforced PBT (Polybutylene Terephthalate)
Potting Material	PUR (Polyurethane)
Weight	100 g (0.22 lb)

Certificates / Lifetime

MTTF	350 years @ 40 °C
Certificates	CE

Interface

Interface	Analog Current 4 - 20 mA + RS232
Teach In	Zero Positioning, Inverse Direction, Elevation Range Programming
Settling Time	125 ms
Output Type	Current 4 - 20 mA
Max Load Resistance	270 Ω @ 10 V DC (500 Ω @ 15 V DC)
Transmission Rate	RS232: min. 1200 Baud; max. 115200 Baud
Default Transmission Rate	RS232: 9600 Baud
Linearity	\pm 0.02%

POSITAL

FRABA

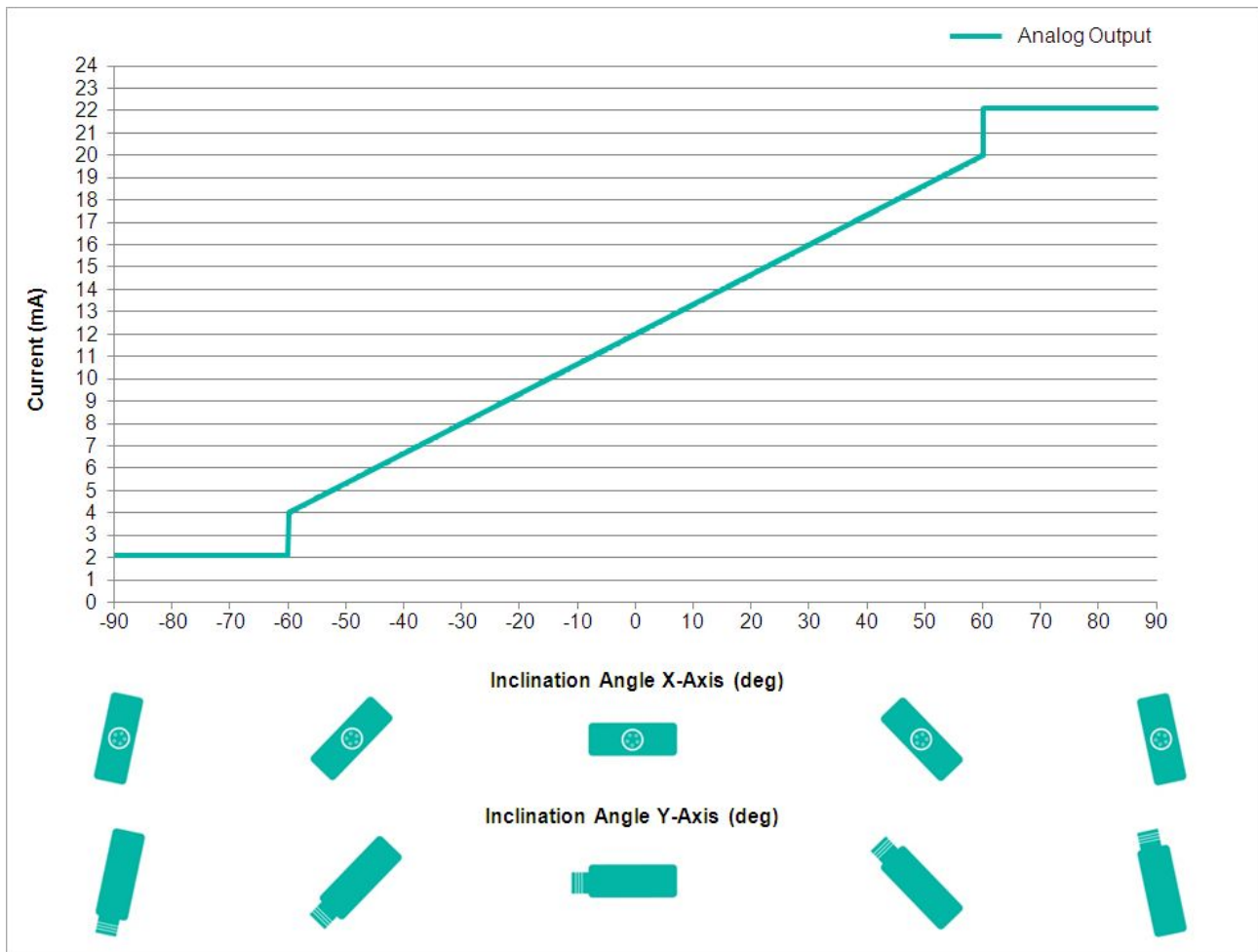

Electrical Connection

Connection Type	Connector M12
Connector	M12, Male, 8 pin, a coded

Product Life Cycle

Product Life Cycle	Established
--------------------	-------------

POSITAL

FRABA



Connection Plan

SIGNAL	PIN NUMBER
Power Supply	1
GND	4
X-Axis, Current Output	5
Y-Axis, Current Output	7
Set1	6
Set2	8
RxD	2
TxD	3

Dimensional Drawing

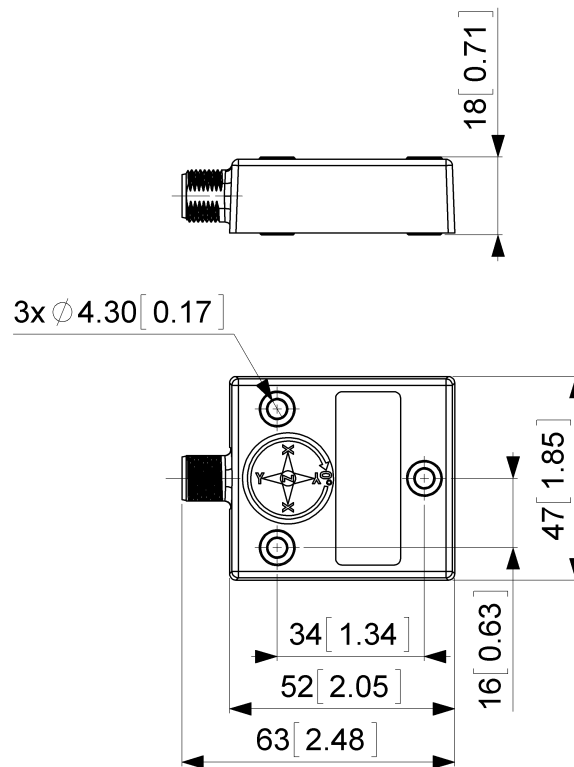

[2D Drawing](#)

Accessories

Cable/Connectors

- 5m PUR Cable, 8pin, A-Coded, f
- 10m PUR Cable, 8pin, A-Coded, f
- 2m PUR Cable, 8pin, A-Coded, f
- 10m PUR Cable, 8pin, A-Coded, f
- M12, 8pin A-Coded, Female
- More

Contact

POSITAL

FRABA



POSITAL
Contact Us

All dimension in [inch] mm. This drawing and the information contained is for general presentation purposes only. Please refer to the "Download" section for detailed technical drawings. © FRABA B.V., All rights reserved. We do not assume responsibility for technical inaccuracies or omissions. Specifications are subject to change without notice.