



## TILTIX Inclinometer

ACS-060-2-SV40-HK2-PM

POSITAL  
FRABA



### General Specifications

Application	2-Axes Position Monitoring and Leveling
Measurement Range	$\pm 60^\circ$
Absolute Accuracy	0.10°
Resolution	0.01°

### Electrical Specifications

Supply Voltage	10 - 30 VDC
Power Consumption (no load)	$\leq 0.7$ W
EMC: Emitted Interference	DIN EN 61000-6-4
EMC: Noise Immunity	DIN EN 61000-6-2
Reverse Polarity Protection	Yes
Short Circuit Protection	Yes

### Environmental Specifications

Operating Temperature	-40 °C (-40 °F) - +85 °C (+185 °F)
Storage Temperature	-40 °C (-40 °F) - +85 °C (+185 °F)
Temperature Gradient	0.004°/ K
Protection Class	IP68/IP69K
Shock Resistance	$\leq 100$ g (half sine 6 ms, EN 60068-2-27)
Vibration Resistance	1.5 mm (10 Hz - 58 Hz) & $\leq 20$ g (58 Hz to 2000 Hz)

Data Sheet

Printed at 27-09-2017 12:09

# POSITAL

---

## FRABA



### Mechanical Specifications

Housing Material	Die-Cast Aluminum Alloy
Potting Material	PUR (Polyurethane)
Weight	220 g (0.49 lb)

### Certificates / Lifetime

MTTF	400 years @ 40 °C
Certificates	CE

### Interface

Interface	Analog Voltage 0.5-9.5 V + RS232
Teach In	Zero Positioning, Inverse Direction, Elevation Range Programming
Settling Time	125 ms
Output Type	Voltage 0.5 - 9.5 V
Min Load Resistance	5 kΩ
Transmission Rate	RS232: min. 1200 Baud; max. 115200 Baud
Default Transmission Rate	RS232: 9600 Baud
Linearity	± 0.02%

# POSITAL

## FRABA

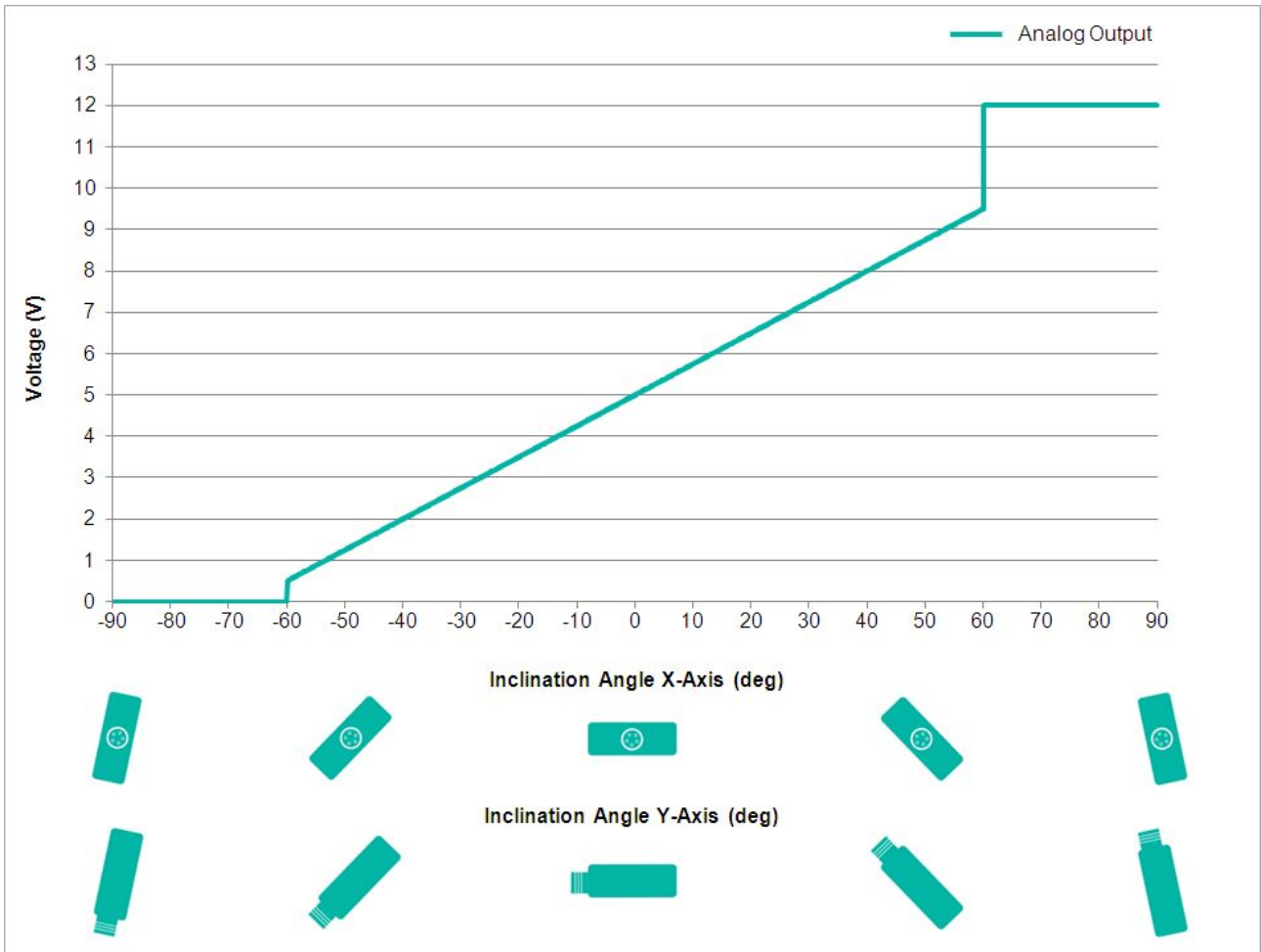

### Electrical Connection

Connection Type	Connector M12
Connector	M12, Male, 8 pin, a coded

### Product Life Cycle

Product Life Cycle	Established
--------------------	-------------

# POSITAL

## FRABA



### Connection Plan

SIGNAL	PIN NUMBER
Power Supply	1
GND	4
X-Axis, Voltage Output	5
Y-Axis, Voltage Output	7
Set1	6
Set2	8
RxD	2
TxD	3

### Dimensional Drawing

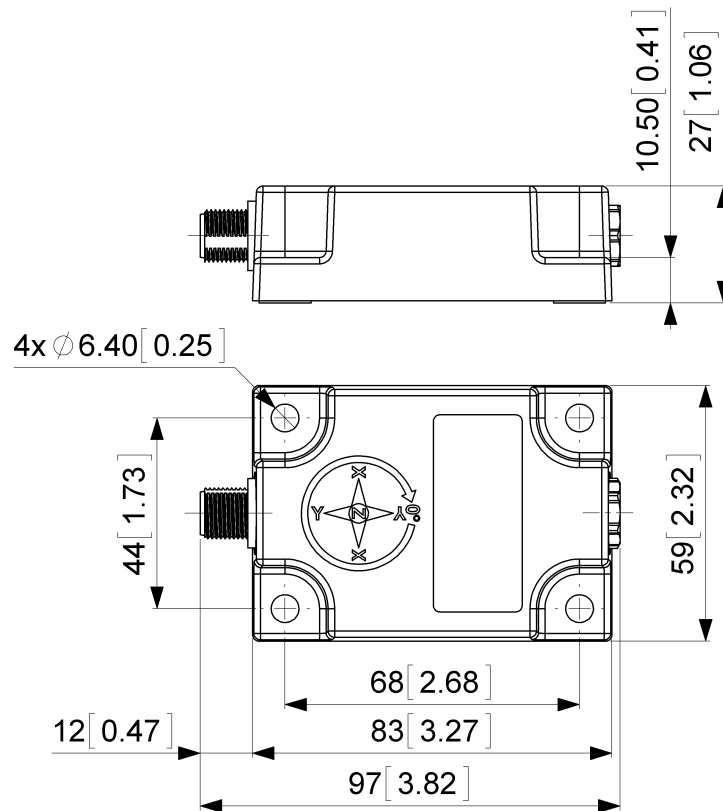

### [2D Drawing](#)

### Accessories

#### Cable/Connectors

- 5m PUR Cable, 8pin, A-Coded, f
- 2m PUR Cable, 8pin, A-Coded, f
- 10m PUR Cable, 8pin, A-Coded, f
- 5m PUR Cable, 8pin, A-Coded, f
- 10m PUR Cable, 8pin, A-Coded, f
- 2m PUR Cable, 8pin, A-Coded, f
- 10m PUR Cable, 8pin, A-Coded, f
- M12, 8pin A-Coded, Female
- More

### Contact

# POSITAL

---

## FRABA



POSITAL  
Contact Us

All dimension in [inch] mm. This drawing and the information contained is for general presentation purposes only. Please refer to the "Download" section for detailed technical drawings. © FRABA B.V., All rights reserved. We do not assume responsibility for technical inaccuracies or omissions. Specifications are subject to change without notice.