



TILTIX Inclinometer

ACS-360-1-S301-VE2-5W

POSITAL
FRABA



General Specifications

Application	1-Axis Position Monitoring and Leveling
Measurement Range	360°
Absolute Accuracy	0.10°
Resolution	0.044°

Electrical Specifications

Supply Voltage	10 - 30 VDC
Current Consumption	≤ 65 mA @ 10 V DC, ≤ 60 mA @ 24 V DC
EMC: Emitted Interference	DIN EN 61000-6-4
EMC: Noise Immunity	DIN EN 61000-6-2
Reverse Polarity Protection	Yes
Short Circuit Protection	Yes

Environmental Specifications

Operating Temperature	-30 °C fixed (-22 °F), -5 °C flexible (+23 °F) - +70 °C (+158 °F)
Storage Temperature	-40 °C (-40 °F) - +85 °C (+185 °F)
Temperature Gradient	0.004°/ K
Protection Class	IP66/IP67
Shock Resistance	≤ 100 g (half sine 6 ms, EN 60068-2-27)
Vibration Resistance	1.5 mm (10 Hz - 58 Hz) & ≤ 20 g (58 Hz to 2000 Hz)

Data Sheet

Printed at 27-09-2017 13:09

POSITAL

FRABA



Mechanical Specifications

Housing Material	Fibre-Reinforced PBT (Polybutylene Terephthalate)
Potting Material	PUR (Polyurethane)
Weight	450 g (0.99 lb)

Certificates / Lifetime

MTTF	300 years @ 40 °C
Certificates	CE

Interface

Interface	SSI Gray
Settling Time	320 ms
Output Driver	Line Driver according to RS422

Electrical Connection

Connection Type	Cable 5 m
Cable Length	5 m [197"]
Wire Cross Section	0.14 mm ² / AWG 26
Material / Type	PVC
Cable Diameter	6 mm (0.24 in)
Minimum Bend Radius	46 mm (1.81") fixed, 61 mm (2.4") flexing

Product Life Cycle

Product Life Cycle	Established
--------------------	-------------

Connection Plan

SIGNAL	CABLE COLOR
Power Supply	Brown
GND	White
Data+	Gray
Data-	Pink
Clock+	Green
Clock-	Yellow
Preset	Blue
DIR	Red
Shielding	Shield



Dimensional Drawing

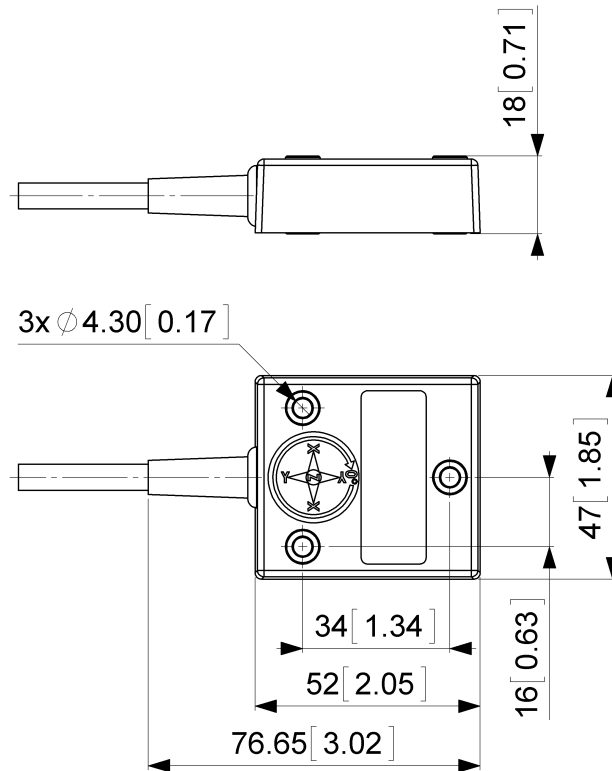

[2D Drawing](#)

Accessories

Contact



POSITAL
Contact Us

All dimension in [inch] mm. This drawing and the information contained is for general presentation purposes only. Please refer to the "Download" section for detailed technical drawings. © FRABA B.V., All rights reserved. We do not assume responsibility for technical

Data Sheet

Printed at 27-09-2017 13:09

POSITAL

FRABA



inaccuracies or omissions. Specifications are subject to change without notice.