



TILTIX Inclinometer

ADS-010-2-AV10-HE2-CW

POSITAL
FRABA



General Specifications

Application	2-Axes Position Monitoring and Leveling
Measurement Range	$\pm 10^\circ$
Absolute Accuracy	0.50°
Resolution	0.01°

Electrical Specifications

Supply Voltage	10 - 30 VDC
Power Consumption (no load)	≤ 0.7 W
EMC: Emitted Interference	DIN EN 61000-6-4
EMC: Noise Immunity	DIN EN 61000-6-2
Reverse Polarity Protection	Yes
Short Circuit Protection	Yes

Environmental Specifications

Operating Temperature	-30 °C fixed (-22 °F), -5 °C flexible (+23 °F) - +70 °C (+158 °F)
Storage Temperature	-40 °C (-40 °F) - +85 °C (+185 °F)
Temperature Gradient	0.004°/ K
Protection Class	IP66/IP67
Shock Resistance	≤ 100 g (half sine 6 ms, EN 60068-2-27)
Vibration Resistance	1.5 mm (10 Hz - 58 Hz) & ≤ 20 g (58 Hz to 2000 Hz)

Data Sheet

Printed at 27-09-2017 13:09

POSITAL

FRABA



Mechanical Specifications

Housing Material	Fibre-Reinforced PBT (Polybutylene Terephthalate)
Potting Material	PUR (Polyurethane)
Weight	170 g (0.37 lb)

Certificates / Lifetime

MTTF	400 years @ 40 °C
Certificates	CE

Interface

Interface	Analog Voltage 0 - 5 V
Settling Time	125 ms
Output Type	Voltage 0 - 5 V
Min Load Resistance	5 k Ω
Linearity	\pm 0.02%

POSITAL

FRABA



Electrical Connection

Connection Type	Cable 1 m
Cable Length	1 m [39"]
Wire Cross Section	0.14 mm ² / AWG 26
Material / Type	PVC
Cable Diameter	6 mm (0.24 in)
Minimum Bend Radius	46 mm (1.81") fixed, 61 mm (2.4") flexing

Product Life Cycle

Product Life Cycle	Established
--------------------	-------------

Connection Plan

SIGNAL	CABLE COLOR
Power Supply	Red

Data Sheet

Printed at 27-09-2017 13:09

POSITAL

FRABA



GND	Yellow
X-Axis, Voltage Output	Green
Y-Axis, Voltage Output	Blue
Set1	Brown
Do Not Connect	Gray
Do Not Connect	Pink
Do Not Connect	White
Shielding	Shield

Dimensional Drawing

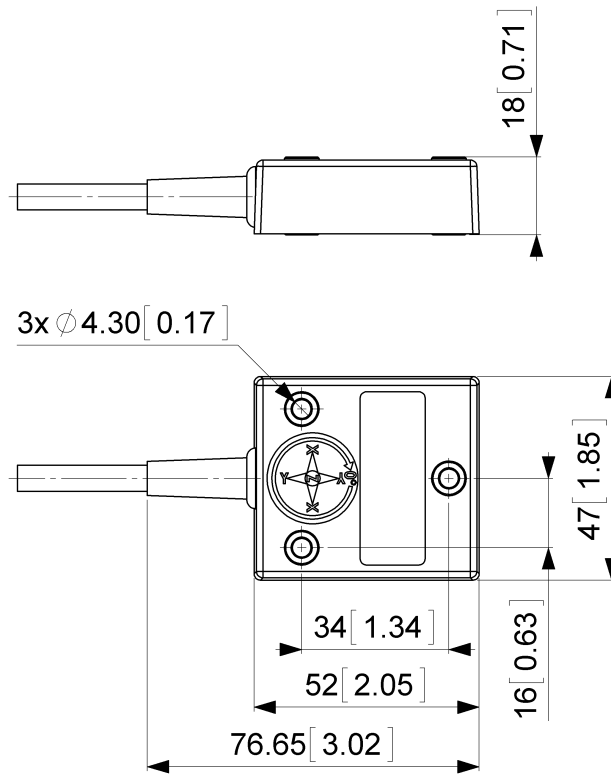

[2D Drawing](#)

Accessories

Contact

Data Sheet
Printed at 27-09-2017 13:09

POSITAL

FRABA



POSITAL
Contact Us

All dimension in [inch] mm. This drawing and the information contained is for general presentation purposes only. Please refer to the "Download" section for detailed technical drawings. © FRABA B.V., All rights reserved. We do not assume responsibility for technical inaccuracies or omissions. Specifications are subject to change without notice.