



TILTIX Inclinometer

ACS-010-2-SV00-HE2-PM

POSITAL
FRABA



General Specifications

Application	2-Axes Position Monitoring and Leveling
Measurement Range	$\pm 10^\circ$
Absolute Accuracy	0.10°
Resolution	0.01°

Electrical Specifications

Supply Voltage	10 - 30 VDC
Power Consumption (no load)	≤ 0.7 W
EMC: Emitted Interference	DIN EN 61000-6-4
EMC: Noise Immunity	DIN EN 61000-6-2
Reverse Polarity Protection	Yes
Short Circuit Protection	Yes

Environmental Specifications

Operating Temperature	-40°C (-40°F) - $+85^\circ\text{C}$ ($+185^\circ\text{F}$)
Storage Temperature	-40°C (-40°F) - $+85^\circ\text{C}$ ($+185^\circ\text{F}$)
Temperature Gradient	$0.004^\circ/\text{K}$
Protection Class	IP66/IP67
Shock Resistance	≤ 100 g (half sine 6 ms, EN 60068-2-27)
Vibration Resistance	1.5 mm (10 Hz - 58 Hz) & ≤ 20 g (58 Hz to 2000 Hz)

POSITAL

FRABA



Mechanical Specifications

Housing Material	Fibre-Reinforced PBT (Polybutylene Terephthalate)
Potting Material	PUR (Polyurethane)
Weight	100 g (0.22 lb)

Certificates / Lifetime

MTTF	400 years @ 40 °C
Certificates	CE

Interface

Interface	Analog Voltage 0.5-4.5 V + RS232
Teach In	Zero Positioning, Inverse Direction, Elevation Range Programming
Settling Time	125 ms
Output Type	Voltage 0.5 - 4.5 V
Min Load Resistance	5 kΩ
Transmission Rate	RS232: min. 1200 Baud; max. 115200 Baud
Default Transmission Rate	RS232: 9600 Baud
Linearity	± 0.02%

POSITAL

FRABA



Electrical Connection

Connection Type	Connector M12
Connector	M12, Male, 8 pin, a coded

Product Life Cycle

Product Life Cycle	Established
--------------------	-------------

POSITAL

FRABA



Connection Plan

SIGNAL	PIN NUMBER
Power Supply	1
GND	4
X-Axis, Voltage Output	5
Y-Axis, Voltage Output	7
Set1	6
Set2	8
RxD	2
TxD	3

Dimensional Drawing

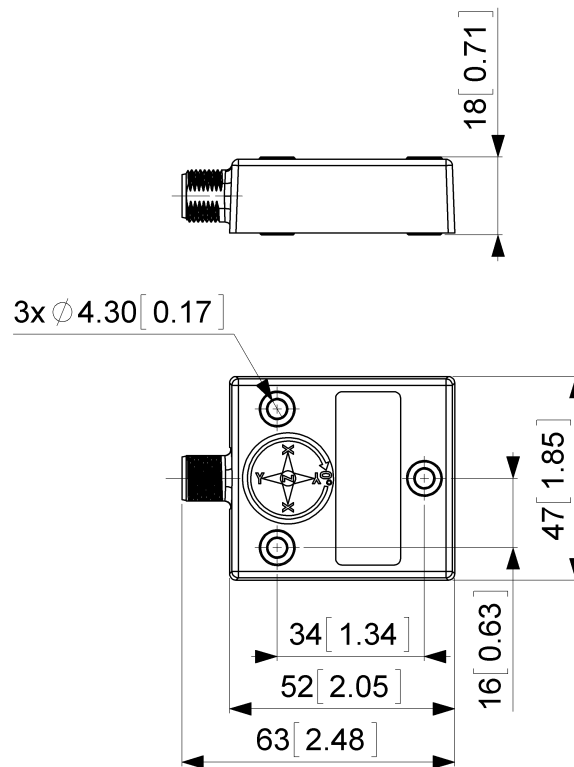

[2D Drawing](#)

Accessories

Cable/Connectors

- 5m PUR Cable, 8pin, A-Coded, f
- 10m PUR Cable, 8pin, A-Coded, f
- 2m PUR Cable, 8pin, A-Coded, f
- 10m PUR Cable, 8pin, A-Coded, f
- M12, 8pin A-Coded, Female
- More

Contact

POSITAL

FRABA



POSITAL
Contact Us

All dimension in [inch] mm. This drawing and the information contained is for general presentation purposes only. Please refer to the "Download" section for detailed technical drawings. © FRABA B.V., All rights reserved. We do not assume responsibility for technical inaccuracies or omissions. Specifications are subject to change without notice.