



POSITAL

FRABA

IXARC Absolute Rotary Encoder

UCD-CA01B-1512-HCS0-2RW



Interface

Interface	CANopen
Profile	DS-406
Programming Functions	Resolution, preset, 2 limit switches, 8 CAMS, baud rate, CAN-Identifier, bootloader, transmission modes: polled, cyclic, sync
Features	Round Axis
Transmission Rate	min. 20 kBaud, max. 1 MBaud
Interface Cycle Time	≥ 1 ms
Video Manual	▶ Watch a simple installation video

Outputs

Output Driver	Transceiver (ISO 11898), Galvanically Isolated by Opto-Couplers
---------------	---

Electrical Data

Supply Voltage	9 - 30 VDC
Power Consumption	≤ 1.2 W
Reverse Polarity Protection	Yes
Short Circuit Protection	Yes
EMC: Emitted Interference	DIN EN 61000-6-4
EMC: Noise Immunity	DIN EN 61000-6-2
MTTF	240 years @ 40 °C

Data Sheet

Printed at 27-09-2017 23:09



POSITAL

FRABA

Sensor

Technology	Magnetic
Resolution Singleturn	12 bit
Resolution Multiturn	15 bit
Multiturn Technology	Self powered magnetic pulse counter (no battery, no gear)
Accuracy (INL)	$\pm 0.0878^\circ$ (≤ 12 bit)
Code	Binary

Environmental Specifications

Protection Class (Shaft)	IP65
Protection Class (Housing)	IP66/IP67
Operating Temperature	-30 °C fixed (-22 °F), -5 °C flexible (+23 °F) - +80 °C (+176 °F)
Storage Temperature	-40 °C (-40 °F) - +85 °C (+185 °F)
Humidity	98% RH, no condensation

Mechanical Data

Connection Cap Material	None
Housing Material	Steel
Housing Coating	Wet coating (RAL 9006 White Aluminium) + Cathodic corrosion protection (>720 h salt spray resistance)
Flange Type	Blind Hollow, \varnothing 58 mm (H)
Flange Material	Aluminum
Shaft Type	Blind Hollow, Depth = 28 mm
Shaft Diameter	\varnothing 12 mm (0.47")
Shaft Material	Stainless Steel V2A (1.4305, 303)
Rotor Inertia	≤ 30 gcm ² [≤ 0.17 oz-in ²]
Friction Torque	≤ 3 Ncm @ 20 °C (4.2 oz-in @ 68 °F)
Max. Permissible Mechanical Speed	≤ 12000 1/min
Shock Resistance	≤ 100 g (half sine 6 ms, EN 60068-2-27)
Permanent Shock Resistance	≤ 10 g (half sine 16 ms, EN 60068-2-29)
Vibration Resistance	≤ 10 g (10 Hz - 1000 Hz, EN 60068-2-6)
Length	71,2 mm (2.80")
Weight	470 g (1.04 lb)

Electrical Connection

Data Sheet

Printed at 27-09-2017 23:09



POSITAL

FRABA

Connection Orientation	Radial
Connection Type	Cable / Connector
Cable Length	2 m [79"]
Wire Cross Section	0.14 mm ² / AWG 26
Material / Type	PVC
Cable Diameter	6 mm (0.24 in)
Minimum Bend Radius	46 mm (1.81") fixed, 61 mm (2.4") flexing

Certification

Approval	CE + cULus listed, Industrial Control Equipment + E1
Product Life Cycle	Established

Connection Plan

SIGNAL	CABLE COLOR
Power Supply	Red
GND	Yellow
CAN High	White
CAN Low	Brown
CAN GND	Green

Connector-View on Encoder



POSITAL

FRABA

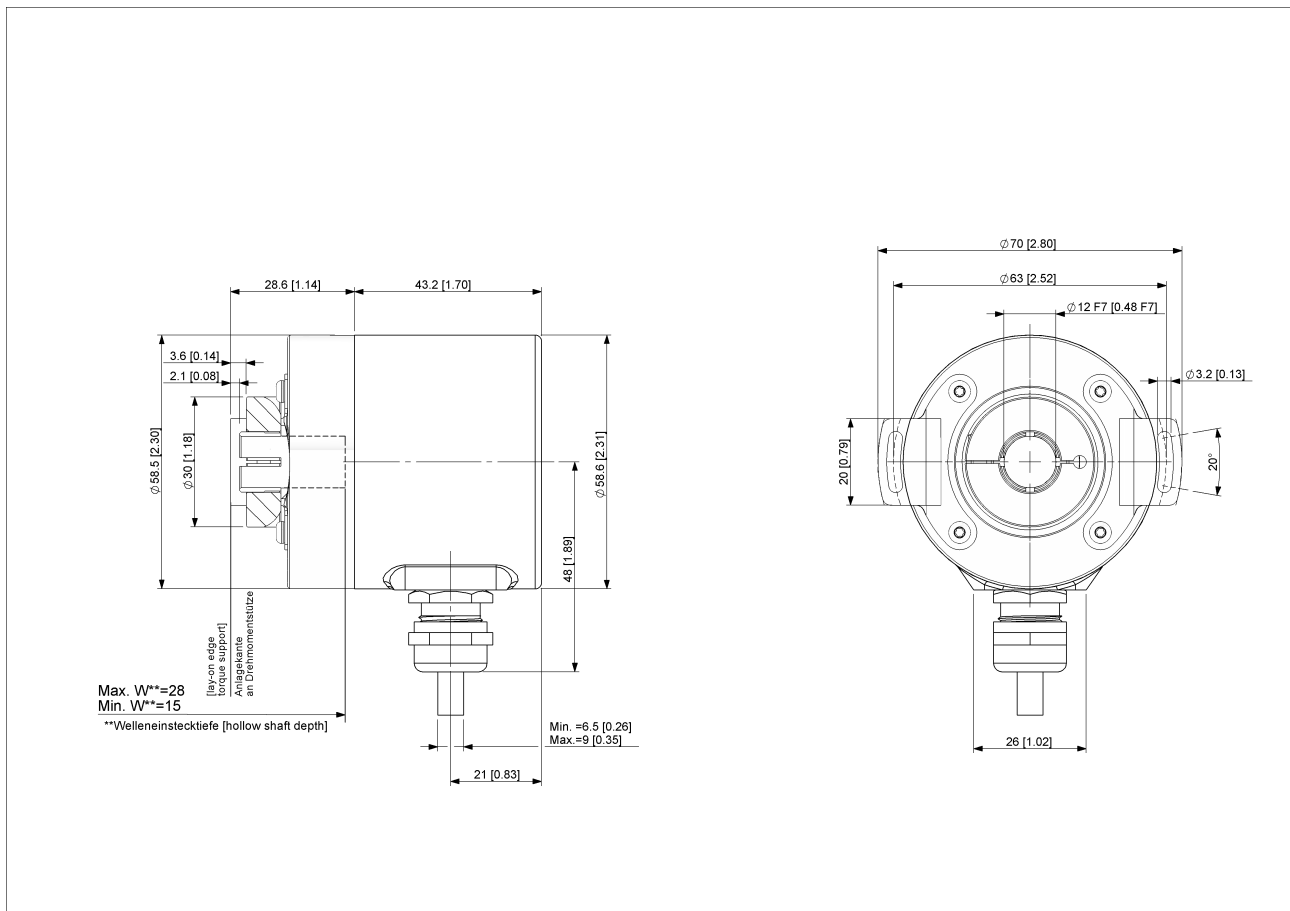

[2D Drawing](#)

Accessories

Clamping Ring Hollow Shaft T120

Contact



POSITAL
Contact Us

The picture and drawing are for general presentation purposes only. Please refer to the "Download" section for detailed technical drawings. All dimension in [inch] mm. © FRABA B.V., All rights reserved. We do not assume responsibility for technical inaccuracies or omissions.

Data Sheet

Printed at 27-09-2017 23:09



POSITAL

FRABA

Specifications are subject to change without notice.