



POSITAL

FRABA

IXARC Absolute Rotary Encoder

UCD-CA01B-1512-HCS0-PRV

This product is a prototype

Interface

Interface	CANopen
Profile	DS-406
Programming Functions	Resolution, preset, 2 limit switches, 8 CAMS, baud rate, CAN-Identifier, bootloader, transmission modes: polled, cyclic, sync
Features	Round Axis
Transmission Rate	min. 20 kBaud, max. 1 MBaud
Interface Cycle Time	≥ 1 ms
Video Manual	▶ Watch a simple installation video

Outputs

Output Driver	Transceiver (ISO 11898), Galvanically Isolated by Opto-Couplers
---------------	---

Electrical Data

Supply Voltage	9 - 30 VDC
Power Consumption	≤ 1.2 W
Reverse Polarity Protection	Yes
Short Circuit Protection	Yes
EMC: Emitted Interference	DIN EN 61000-6-4
EMC: Noise Immunity	DIN EN 61000-6-2
MTTF	240 years @ 40 °C

Sensor

Technology	Magnetic
Resolution Singleturn	12 bit
Resolution Multiturn	15 bit
Multiturn Technology	Self powered magnetic pulse counter (no battery, no gear)
Accuracy (INL)	±0.0878° (≤ 12 bit)
Code	Binary



POSITAL

FRABA

Environmental Specifications

Protection Class (Shaft)	IP65
Protection Class (Housing)	IP66/IP67
Operating Temperature	-40 °C (-40 °F) - +85 °C (+185 °F)
Storage Temperature	-40 °C (-40 °F) - +85 °C (+185 °F)
Humidity	98% RH, no condensation

Mechanical Data

Connection Cap Material	None
Housing Material	Steel
Housing Coating	Wet coating (RAL 9006 White Aluminium) + Cathodic corrosion protection (>720 h salt spray resistance)
Flange Type	Blind Hollow, \varnothing 58 mm (H)
Flange Material	Aluminum
Shaft Type	Blind Hollow, Depth = 28 mm
Shaft Diameter	\varnothing 12 mm (0.47")
Shaft Material	Stainless Steel V2A (1.4305, 303)
Rotor Inertia	$\leq 30 \text{ gcm}^2$ [$\leq 0.17 \text{ oz-in}^2$]
Friction Torque	$\leq 3 \text{ Ncm}$ @ 20 °C (4.2 oz-in @ 68 °F)
Max. Permissible Mechanical Speed	$\leq 12000 \text{ 1/min}$
Shock Resistance	$\leq 100 \text{ g}$ (half sine 6 ms, EN 60068-2-27)
Permanent Shock Resistance	$\leq 10 \text{ g}$ (half sine 16 ms, EN 60068-2-29)
Vibration Resistance	$\leq 10 \text{ g}$ (10 Hz - 1000 Hz, EN 60068-2-6)
Length	71,2 mm (2.80")
Weight	370 g (0.82 lb)

Electrical Connection

Connection Orientation	Radial
Connection Type	Cable / Connector
Connector	M12, Male, 5 pin, a coded, with LED

Certification

Approval	CE + cULus listed, Industrial Control Equipment + E1
Product Life Cycle	Prototype



POSITAL

FRABA



Connection Plan

SIGNAL	PIN NUMBER
Power Supply	2
GND	3
CAN High	4
CAN Low	5
CAN GND	1

Connector-View on Encoder
Dimensional Drawing



POSITAL

FRABA

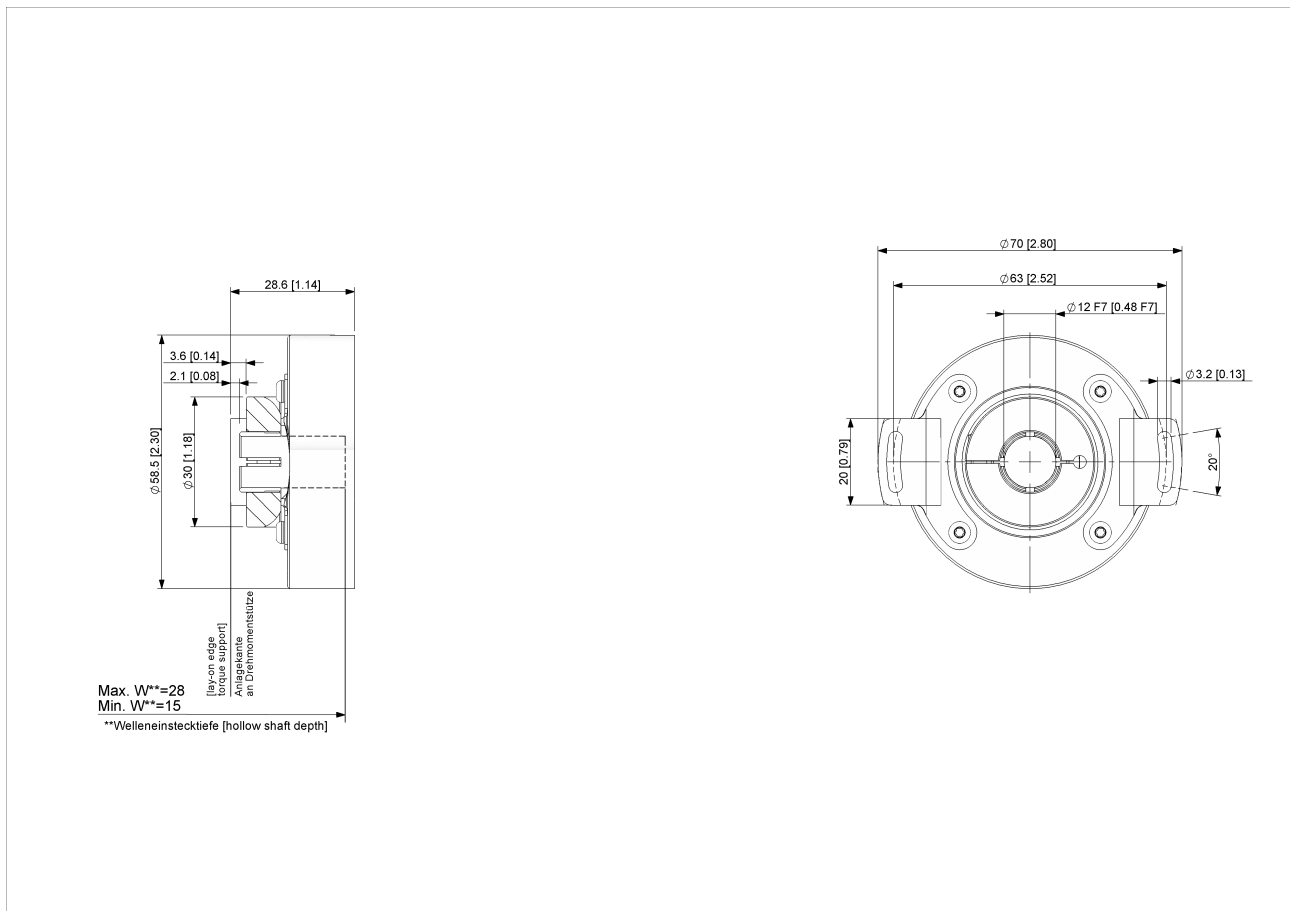

[2D Drawing](#)

Accessories

Connectors & Cables

10m PUR Cable, 5pin, A-Coded, f

2m PUR Cable, 5pin, A-Coded, f

5m PUR Cable, 5pin, A-Coded, f

M12, 5pin A-Coded, Female

More

Clamping Ring Hollow Shaft T120

Contact

Data Sheet

Printed at 27-09-2017 23:09



POSITAL

FRABA



POSITAL
Contact Us

The picture and drawing are for general presentation purposes only. Please refer to the "Download" section for detailed technical drawings. All dimension in [inch] mm. © FRABA B.V., All rights reserved. We do not assume responsibility for technical inaccuracies or omissions. Specifications are subject to change without notice.