



POSITAL

FRABA

IXARC Incremental Encoder

UCD-IPT00-04096-Y06S-2AW



Interface

Interface	Programmable Incremental
Programming Functions	PPR (1-16384), Output, Counting Direction
Configuration Tool	UBIFAST Configuration Tool (Version \geq 1.6.3)

Outputs

Output Driver	RS 422 (TTL)
Quadrature Phasing	$90^\circ \pm 4.5^\circ$ electrical
Output Voltage High Level Push-Pull (HTL)	$> 4 \text{ V}$ @ 4.75-9 V Supply Voltage $> 3 \text{ V}$ @ 9-30 V Supply Voltage
Output Voltage Low Level Push-Pull (HTL)	$< 0.5 \text{ V}$
Output Voltage High Level RS422 (TTL)	$> 4 \text{ V}$
Output Voltage Low Level RS422 (TTL)	$< 0.5 \text{ V}$
Maximum Frequency Response	1 MHz
Maximum Switching Current	50 mA per Channel

Electrical Data

Supply Voltage	4.75 - 30 VDC
Current Consumption	$\leq 140 \text{ mA}$ @ 5V DC, $\leq 70 \text{ mA}$ @ 10V DC, $\leq 40 \text{ mA}$ @ 24V DC
Power Consumption	$\leq 1.0 \text{ W}$
Start-Up Time	$< 250 \text{ ms}$
Min. Load Resistance	120 Ω

Data Sheet

Printed at 16-02-2018 15:02



POSITAL

FRABA

Reverse Polarity Protection	Yes
Short Circuit Protection	Yes
EMC: Emitted Interference	DIN EN 61000-6-4
EMC: Noise Immunity	DIN EN 61000-6-2
MTTF	280 years @ 40 °C

Sensor

Technology	Magnetic
Accuracy (INL)	$\pm 0.0878^\circ$ (≤ 12 bit)
Duty Cycle	$180^\circ \pm 27^\circ$ (Speed > 100RPM)
Phase Angle	$90^\circ \pm 14^\circ$ (Speed > 100RPM)

Environmental Specifications

Protection Class (Shaft)	IP66/IP67
Protection Class (Housing)	IP66/IP67
Operating Temperature	-30 °C fixed (-22 °F), -5 °C flexible (+23 °F) - +70 °C (+158 °F)
Humidity	98% RH, no condensation

Mechanical Data

Mechanical Data

Housing Material	Steel
Housing Coating	Cathodic corrosion protection (>720 hrs salt spray resistance)
Flange Type	Synchro, \varnothing 58 mm (Y)
Flange Material	Aluminum
Shaft Type	Solid, Length = 10 mm
Shaft Diameter	\varnothing 6 mm (0.24")
Shaft Material	Stainless Steel V2A (1.4305, 303)
Max. Shaft Load	Axial 40 N, Radial 110 N
Rotor Inertia	≤ 30 gcm ² [≤ 0.17 oz-in ²]
Friction Torque	≤ 5 Ncm @ 20 °C, (7.1 oz-in @ 68 °F)
Max. Permissible Mechanical Speed	≤ 3000 1/min
Shock Resistance	≤ 100 g (half sine 6 ms, EN 60068-2-27)
Permanent Shock Resistance	≤ 10 g (half sine 16 ms, EN 60068-2-29)
Vibration Resistance	≤ 10 g (10 Hz - 1000 Hz, EN 60068-2-6)

Data Sheet

Printed at 16-02-2018 15:02



POSITAL

FRABA

Length	45,7 mm (1.80")
Weight	675 g (1.49 lb)
Minimum Mechanical Lifetime (10 ⁸ revolutions with Fa/Fr)	400 (20 N / 40 N)

Electrical Connection

Connection Orientation	Axial
Cable Length	2 m [79"]
Wire Cross Section	0.14 mm ² / AWG 26
Material / Type	PVC
Cable Diameter	6 mm (0.24 in)
Minimum Bend Radius	46 mm (1.81") fixed, 61 mm (2.4") flexing

Certification

Approval	CE + cULus listed, Industrial Control Equipment
----------	---

Product Life Cycle

Product Life Cycle	Established
--------------------	-------------

Connection Plan

SIGNAL	CABLE COLOR
A	Green
/A	Yellow
B	Gray
/B	Pink
Z	Blue
/Z	Red
Power Supply	Brown
GND	White
Shielding	Shield

Connector-View on Encoder

Pulse Diagram



POSITAL

FRABA

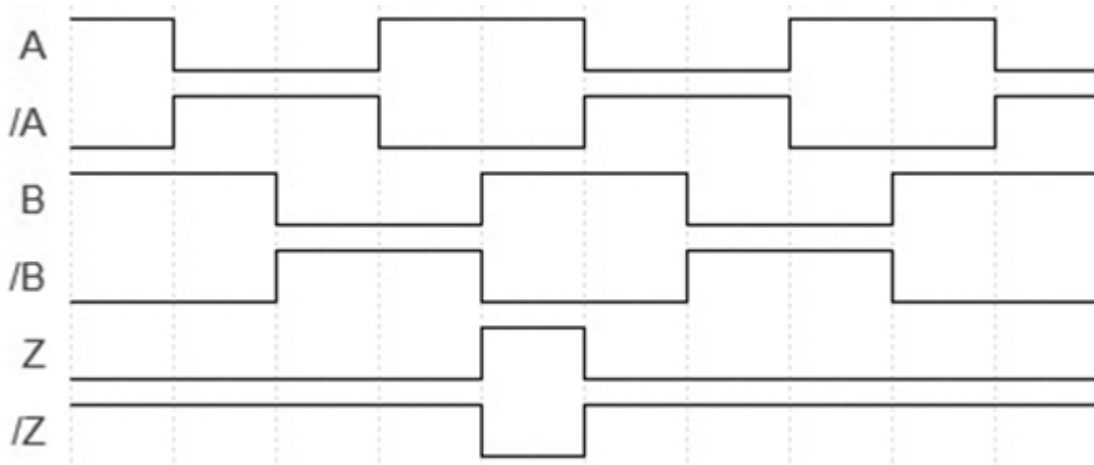

Rotation Clockwise (seen on shaft)

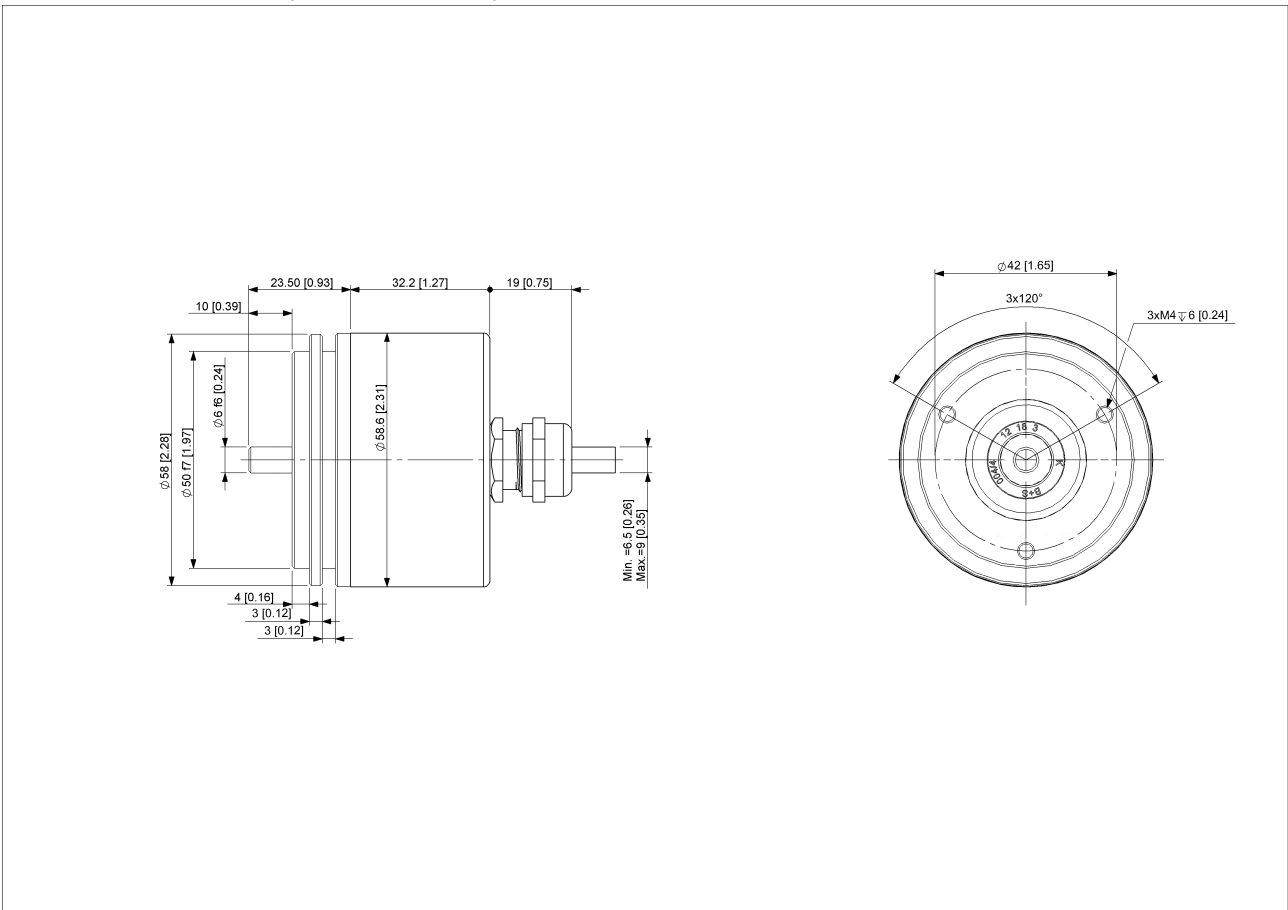

[2D Drawing](#)

Accessories

Configuration/Programming Tools
UBIFAST Configuration Tool

Data Sheet
Printed at 16-02-2018 15:02



POSITAL

FRABA

Couplings

Coupling Bellow Type-06-06

Coupling Bellow Type-06-10

Coupling Bellow Type-06-08

Coupling Bellow Type-06-(3/8")

Coupling Bellow Type-06-(1/4")

Coupling Jaw Type-06-06

Coupling Jaw Type-06-10

Coupling Jaw Type-06-08

Coupling Jaw Type-06-12

Coupling Jaw Type-06-(1/4")

Coupling Jaw Type-06-(3/8")

Coupling Disc Type-06-06

Coupling Disc Type-06-10

More

Adapter Flanges

Mounting Bracket for Synchro Flange w/ fixtures

Displays

AP20-00 Counter

AP20-D0 Counter (4 dig. o/p)

AP20-0A Counter (analog o/p)

AP20-DA Counter (4 dig. + analog o/p)

DiMod Counter (Relay o/p)

More

Clamping Rings

Clamp Disc w/ Eccentric Hole-4pcs

Clamp Disc w/ Centred Hole-4pcs

Contact



Contact Us

The picture and drawing are for general presentation purposes only. Please refer to the "Download" section for detailed technical drawings. All dimension in [inch] mm. © FRABA B.V., All rights reserved. We do not assume responsibility for technical inaccuracies or omissions.

Data Sheet

Printed at 16-02-2018 15:02



POSITAL

FRABA

Specifications are subject to change without notice.