

TO220 35W HIGH POWER RESISTORS
RMP-20S

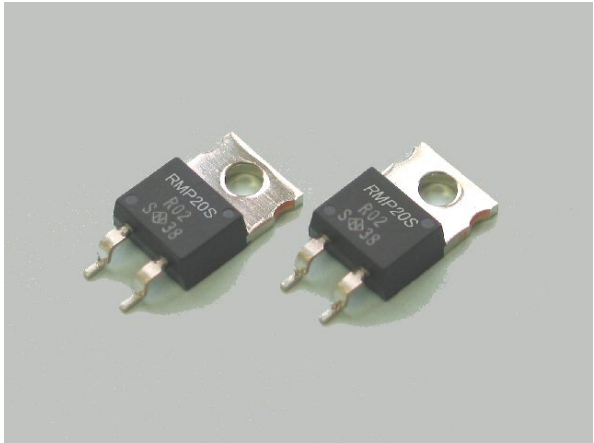

Features and Applications

35W high power resistors in TO220 style mold package for surface mount.
 Non-inductive design suits high frequency applications and high-speed pulse circuits.
 Low, 3.3 °C/W heat resistance from resistor hot spot to flange and long life performance are presented with thin film metallization technology and rejection of plastic adhesive joint.
 Wide 20 milliohm to 51kOhm resistance range, non-inductive impedance characteristic and heat conduction through the insulated metal flange aid circuit designers.
 Small size and thin profile suit high-density compact installations.
 Complete thermal conduction, heat dissipation design and vibration durable design also available.
 Applications include snubber, gate control, bleeder, filter, rush current protection, braking resistors of automotive, rail traction, wind turbine, PV, UPS and motor control inverters.

Dimensional Specifications (mm)

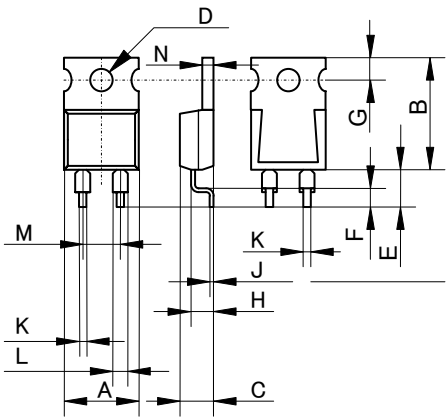

RMP-20S		
	mm	+/-mm
A	10.1	+/-0.2
B	15.0	+/-0.2
C	4.5	+/-0.2
D	3.6	+/-0.1
E	5.0	+/-1.0
F	2.5	+/-0.5
G	3.0	+/-0.2
H	2.75	+/-0.2
J	0.5	+/-0.05
K	0.75	+/-0.05
L	1.5	+/-0.05
M	5.08	+/-0.10

Structure and Materials

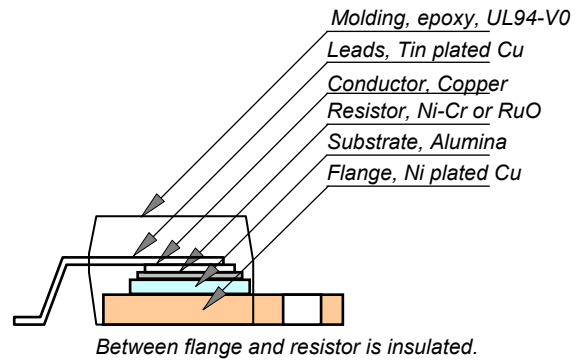

Ordering Information

RMP-20S	C	10R0 (*)	F	Z01	Note
RMP-20S	H(250ppm)	R02-R09 (+E6)	J(5%)	Z01	Tape/500pcs
	A(100ppm)	R10-510K(+E24)	F(1%), J(5%)	Z03	Tube/50pcs
	C(50ppm)	10R-51K (+E24)	F(1%)	Z05	Tray/100pcs

Resistance value (*) is available following modified E24, +E24.

1.0	1.1	1.2	1.3	1.5	1.6	1.8	2.0	2.2	2.4	2.5	2.7	3.0	3.3
3.6	3.9	4.0	4.3	4.7	5.0	5.1	5.6	6.2	6.8	7.5	8.0	8.2	9.1

Note*: When ordering, additional ohm resistance notation is recommended for keeping out of misunderstanding.

35W HIGH POWER RESISTORS

RMP-20S

Specifications

Type	RMP-20S			Test Conditions
Rating Power	35 W			-55 °C to 25 °C flange temperature
Rating Power	1 Watt			Free air.
Heat Resistance	3.3 ° C/W			Hot spot to flange
Resistance Range	0.01-0.091 Ohm	0.1-510 k Ohm	10-51k Ohm	Note 2
Nominal Resistance	E6	E24+	E24	Include 2.5, 4.0, 5.0, 8.0 and 16
TCR(ppm/° C)	250(H)*	100 (A)	50 (C)	Note 3
Tolerance	5%(J)	1% (F), 5% (J)	+/-1% (F)	1% tolerance at 0.01-0.091 ohm is available optionally.
	Thick Film		Thin Film	
Capacitance	1.44pF			Equivalent parallel capacitance.
Inductance	8.38nH			Equivalent series inductance
Operation Temp.	-55 °C to +175 °C			
Max. Operating Volt.	smaller value either 700V or $\sqrt{P \cdot R}$			P is rating power and R resistance
Withstanding Volt.	2000 VAC			Terminal and flange, 60 seconds, 1mA
Load Life	+/- 1.0 %			25 °C, 90 min. ON, 30 min. OFF, 1000 hours.
Humidity	+/- 1.0 %			40C, 90-95%RH, DC 0.1W, 1000 hours.
Temp. Cycle	+/- 0.25 %			-55 °C,30 min.,+155 °C,30 min., 5cycles
Soldering Heat	+/- 0.1 %			350+/-5 °C, 3seconds,
Solder ability	Over 95% of surface			230+/-5 °C, 3seconds.
Insulation Resistance	Over 1,000 Meg ohm			Between terminals and flange.
Vibration	+/- 0.25 %			IEC60068-2-6, see note 4
Weight	2.1 grams			

Derating

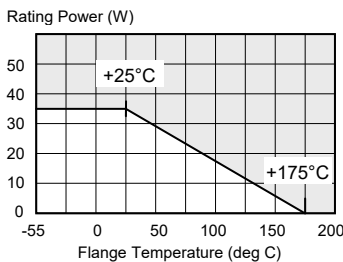

Temperature Rise

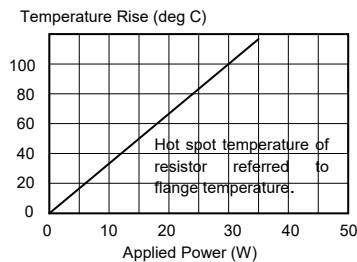

Typical TCR in Low Ohms

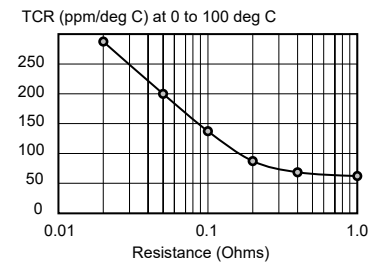

Pulse Energy Durability

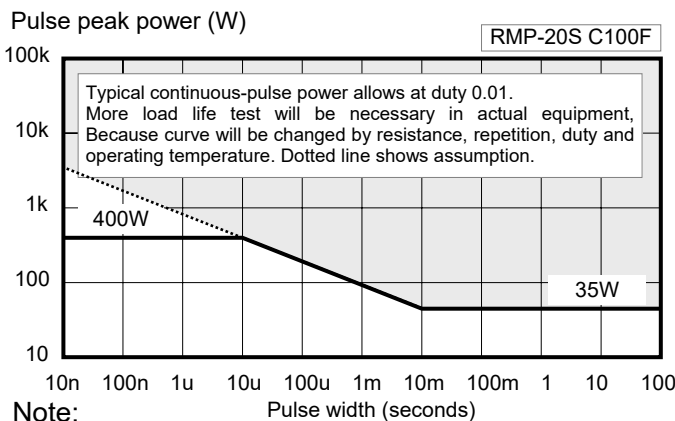

Frequency Characteristics

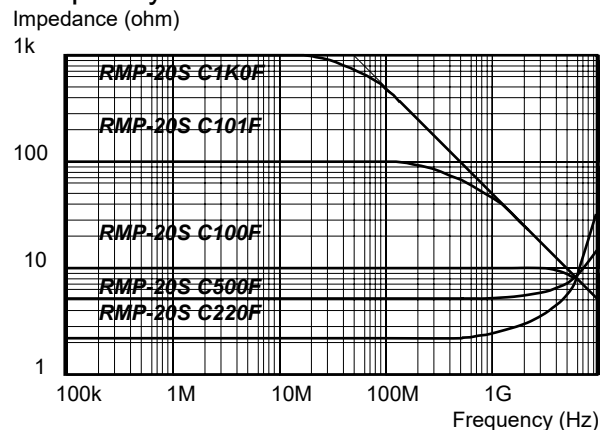

Note:

- Insulating material is unnecessary between flange and heat-sink, flange and resistor is separated by alumina substrate.
- Resistance measurement shall be made at a point 5.27mm +/-0.6 mm from the resistor body.
- TCR of low resistance will be increased as 300ppm/0.02ohm, 200ppm/0.05ohm, 140ppm/0.1ohm and 80ppm/0.2ohm typically. Testing point is at 5.27mm from bottom of molding of terminals.
- Test method is IEC60068-2-6, and specification is sine sweep wave form, 100Hz-2000Hz, 10 cycles, amplitude 0.75mm or 100m/s², 90minutes. direction x-y z, Amplitude 0.75mm will be applied under break point Frequency (about 60Hz) and 100m/ s² over break point
- When mounting resistor on heat-sink by screw, clip and pressure strip with using heat conduction grease on back side of resistor are recommended. Recommended screw torque is 0.5-0.6Nm.
- 0.1% tolerance resistors is available, please see datasheet of RNP-20P.
- Standard packaging is RoHS PS/PE tube packaging, which contains 50pcs / tube.

SMD 35W HIGH POWER RESISTORS

RMP-20S

Applications, RMP-20S

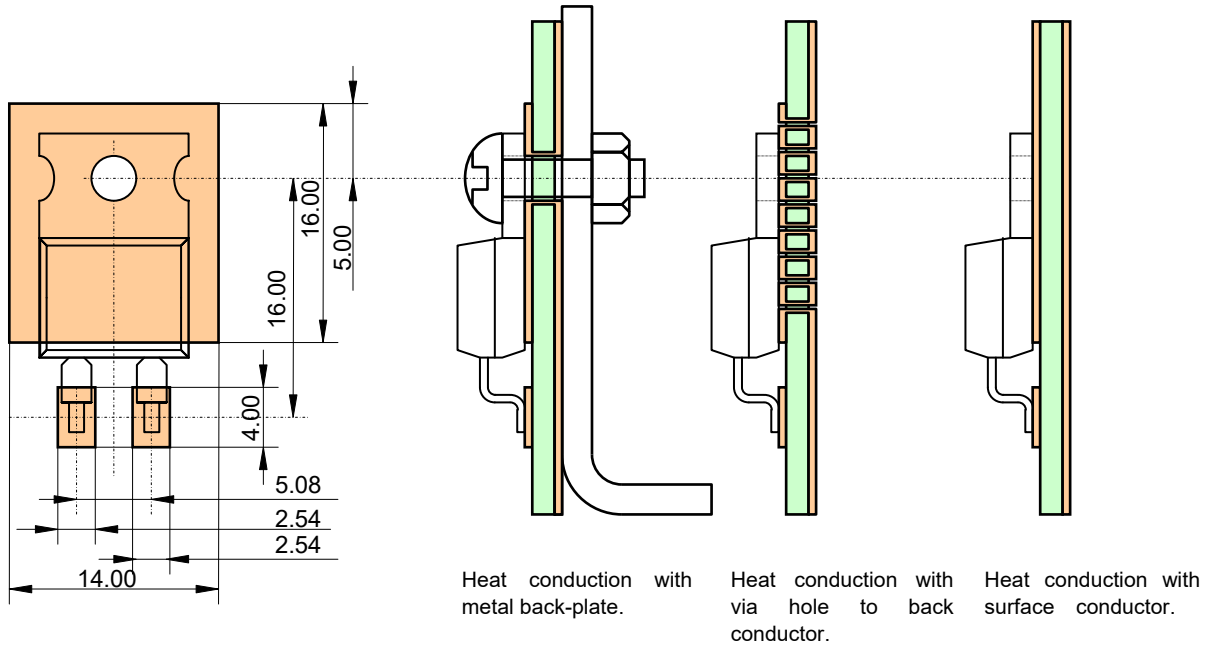

Tape Reel, RMP-20S (500pcs/reel)

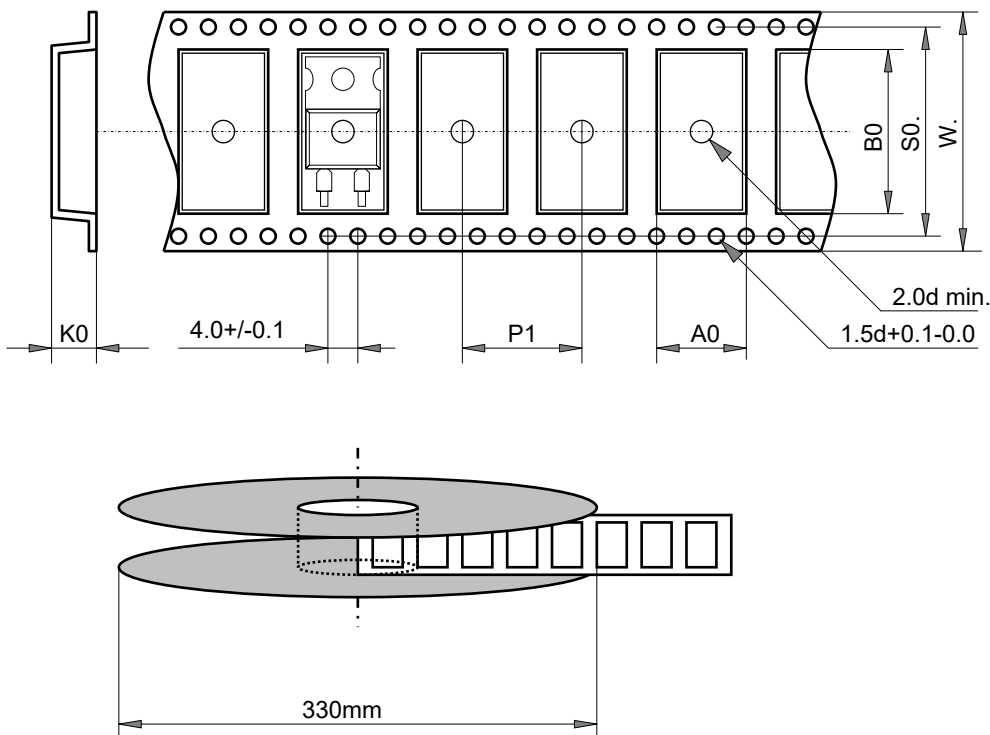

A0	10.56+/-0.1
B0	20.72+/-0.1
K0	6.10+/-0.1
P1	16.00+/-0.1
S0	28.40+/-0.1
W	32.00+/-0.3