

VarioTrack

MPPT solar charge regulator

User Manual

VarioTrack VT- 65

12/24/48V- 65A

VarioTrack VT- 80

12/24/48V- 80A



Accessories:

Remote control.....	RCC-02/-03
Temperature sensor	BT5-01
Auxiliary cooling fan.....	ECF-01
External auxiliary relay module.....	ARM-02

Contents

1	INTRODUCTION	5
2	GENERAL INFORMATION	5
2.1	About this user manual	5
2.2	Important safety instructions	6
2.3	Conventions	6
2.4	Quality and warranty	6
2.4.1	Exclusion of warranty	7
2.4.2	Exclusion of liability	7
2.5	Warnings and guidelines	7
3	MOUNTING AND INSTALLATION	8
3.1	Storage	8
3.2	Unpacking	8
3.3	Mounting place	8
3.4	Fixing / Dimensions	9
3.4.1	Assembling the cooling fan (model VT-80)	9
4	WIRING	10
4.1	Elements of the cable compartment	10
4.2	Connection compartment	11
4.3	Photovoltaic generator (PV)	12
4.3.1	Dimensioning	12
4.3.2	Serial connection (string) of PV modules	12
4.3.3	Parallel connection of PV module strings	12
4.3.4	Safe use of the photovoltaic modules	13
4.3.5	Protection devices	13
4.3.6	Cable cross-section	13
4.3.7	Parallel connection of several VarioTracks	13
4.4	Connecting the battery	14
4.4.1	Dimensioning the battery	14
4.4.2	Precautions when using the batteries	15
4.4.3	Connecting the battery	15
4.4.4	Protection device of the battery	16
4.5	Multi-unit configurations	16
4.5.1	Extension of an existing installation	17
4.6	Earthing guidelines	17
4.6.1	Detection of earth fault	18
4.7	Lightning protection	18
4.8	Connecting the communication cables	18
5	POWER-UP OF THE EQUIPMENT	19
5.1.1	Wiring errors and their symptoms	20
6	DISPLAY SYSTEM	21
6.1	The "SET" button (4)	21
6.2	"Night" standby indicator (1)	21
6.3	"Charge" cycle indicator (2)	21
6.4	"Error" indicator (3)	22
6.5	Charging current Indicator (5)-(6)-(7)-(8)	22
7	BATTERY CHARGING PROCESS	23
7.1	General points	23
7.2	Battery cycle	23
7.2.1	Bulk phase	23
7.2.2	Absorption phase	23
7.2.3	Floating phase	23
7.2.4	Equalization phase	23
7.2.5	Temperature compensation	24
7.3	Default battery charge cycle (original settings)	25
8	CONFIGURING THE VARIOTRACK(S)	25
8.1	Configuring the equipment by means of the internal DIP switches	25

8.2	Displaying the equipment status using the remote control RCC-02/-03	26
8.2.1	Displaying the status of a single unit system	26
8.2.2	Displaying the operating mode of the equipment (Info n° 11016)	28
8.2.3	Displaying security errors (Info n°11034)	28
8.2.4	Displaying the values of a multi-unit system.....	28
8.2.5	Displaying messages and event history	28
8.3	Configuring the VarioTrack using the remote control RCC-02/03	29
8.3.1	The real time clock.....	30
8.4	Description of the VarioTrack parameters.....	30
8.4.1	Convention	30
8.4.2	Parameter access level	30
8.4.3	Organisation of the configuration menu.....	30
8.4.4	Basic menu {10000} (menu).....	31
8.4.5	Management and battery cycle {10003} (menu)	32
8.4.6	Floating phase {10004} (menu).....	33
8.4.7	Absorption phase {10007} (menu)	33
8.4.8	Equalization phase {10016} (menu)	33
8.4.9	New cycle {10028} (Menu)	35
8.4.10	System {10038} (menu)	36
8.4.11	Auxiliary contacts 1 {10088} and 2 {10142} (menu).....	37
8.4.12	Simple functions	37
9	ACCESSORIES	40
9.1	Remote control and programming centre RCC-02/-03	40
9.2	Temperature sensor BTS-01	41
9.2.1	Connecting the temperature sensor (BTS-01).....	42
9.3	Auxiliary relay module ARM-02.....	42
9.4	External cooling fan ECF-01	42
10	EQUIPMENTS COMPATIBLE WITH THE VARIOTRACKS	43
10.1	Xtender inverters/chargers	43
10.2	Battery status processor BSP- 500/1200.....	43
10.3	Communication module Xcom-232i.....	43
10.4	Communication sets Xcom-LAN/-GSM	43
11	WIRING EXAMPLES	44
11.1	VarioTrack + RCC-02	44
11.2	Comments on the wiring examples	44
11.3	VarioTrack + Xtender + RCC-02 + BSP + BTS-01 hybrid system	45
12	MAINTENANCE OF THE INSTALLATION	46
13	PRODUCT RECYCLING.....	46
14	EC DECLARATION OF CONFORMITY.....	46
15	PARAMETER LIST	47
16	PARAMETER LIST FOR THE AUXILIARY RELAYS	48
17	TECHNICAL DATA	51
17.1	Input (PV generator)	51
17.2	Output (battery).....	51
17.3	Environment	51
17.4	Electronic protection.....	51
18	INDEX OF PARAMETERS	52
19	NOTES	53

1 INTRODUCTION

Congratulations! You are about to install and use an apparatus from the VarioTrack range. You have chosen high-tech equipment that will play a central role in the energy production of your solar electrical installation. The VarioTrack has been designed to work as a solar battery charger; its advanced and completely configurable functionalities will guarantee a perfect functioning of your energy system.

When the VarioTrack is connected to batteries and photovoltaic panels, it automatically recharges batteries in an optimum way with all the available solar power.

The accuracy of the Maximum Power Point Tracking (MPPT) algorithm, the high output and low internal consumption ensure an optimal valorisation of the energy produced by the PV modules.

The charge profile may be set freely according to the battery type or the operation mode. The charging voltage is corrected depending on the temperature thanks to the optional external sensor BTS-01.

The control, display and programming unit RCC-02/-03 (optional) allows an optimal setup of the system and guarantees the user a permanent control over all important parameters for the installation with a clear display interface. Moreover, it allows recording the system data in order to analyse later its functioning (data logging).

The parallel operation of several chargers is possible and offers modularity and flexibility enabling an optimum dimensioning of your system according to your energy requirements.

The VarioTrack operates as an independent device but is also designed to be included into a Studer energy system together with the Xtender inverters/chargers, the BSP battery monitor, the configuration and display module RCC-02/-03 and the communication module Xcom-232i. Working together, these different devices have a synchronised behaviour for a better management of the battery and of the solar resource.

Please read this manual carefully to ensure the perfect start up and operation of your system. It contains all the necessary information regarding the operation of the VarioTrack charger. The installation of such a system requires special expertise and may only be carried out by qualified personnel familiar with the local standards in force.

2 GENERAL INFORMATION

2.1 ABOUT THIS USER MANUAL

This manual contains all the necessary information and procedures to install, configure, use and troubleshoot the VarioTrack charge regulators. It does not contain information about photovoltaic modules (PV) or batteries of various brands that can be connected. For this kind of information, please refer to the instructions of each specific manufacturer.

It covers the following models and accessories:

- Charger: **VarioTrack VT-65 – VarioTrack VT-80**
- Temperature sensor: **BTS-01**
- Cooling fan: **ECF-01**
- External auxiliary relay module: **ARM-02**

Note: The VarioTrack solar charger has a different specification dependent upon whether it is equipped with a cooling fan (model supplied under reference VT-80) or not (model supplied under reference VT-65). It is also possible to add the ECF-01 cooling fan on a VT-65 model later (see chap. 9.4). If the fan is added, the specification will become that of a VT-80.

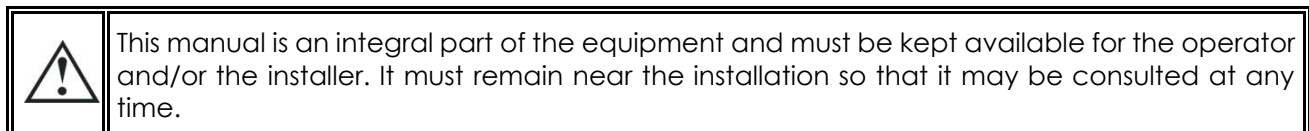

2.2 IMPORTANT SAFETY INSTRUCTIONS

This manual contains important safety instructions. Read carefully the safety and operation instructions before using the VarioTrack. Take into consideration all the warnings mentioned both on the equipment and in this manual following all the instructions regarding the operation and use.





For clarity's sake, in this manual the equipment is called VarioTrack, unit or equipment when the operation description applies either to the VT-65 or VT-80 model.

This user manual is intended to serve as a guideline for the safe and efficient use of the VarioTrack. Anyone who installs or uses a VarioTrack can completely rely on this user manual and is bound to observe all the safety instructions and indications herein.

This manual does not contain any information meant for persons other than the personnel qualified for the installation of such a product.

The installation and commissioning of the VarioTrack must be entrusted to qualified personnel. The installation and use must comply with the local safety instructions and standards in force in the country.

2.3 CONVENTIONS

	This symbol is used to indicate safety instructions which, if not followed, could result in serious personal injury or death to the operator or the user.
	This symbol is used to indicate a risk of material damage and/or the cancellation of the guarantee.
	This symbol is used to indicate a procedure or function that is important for a safe and correct use of the equipment. Failure to respect these instructions may lead to the cancellation of the guarantee or to a non-compliant installation.
	This symbol placed on the product indicates that its surfaces may reach temperatures higher than 60°C.
	This symbol placed on the product indicates that its use must follow the instructions in the user's manual.

In general, values important for the operation of the equipment (for example: battery voltage during absorption) are not mentioned and the parameter number is indicated in the following format: {xxxx}. The value of the parameter can be found in the table chap. 15.

In most cases, these values can be modified with the remote control RCC-02/-03 (see chap. 9.1).

	The parameter table available at the end of this manual (p. 47) must be kept updated in case the parameters are modified by the operator or the installer. If an authorised person modifies a parameter not included in the list (advanced parameters), the number of the modified parameter(s), the specifications of the parameter(s) and the new value set are to be indicated at the end of the table.
---	---

All the values that are not followed by a parameter number may not be modified.

All digits and letters indicated in brackets or in square brackets in the text of this manual refer to items represented in illustrations with a circle.

2.4 QUALITY AND WARRANTY

During the production and assembly of the VarioTrack, each unit undergoes several checks and tests which strictly comply with established procedures. The manufacturing, assembling and testing of each VarioTrack are completely carried out in our factory in Sion (CH). The warranty for this equipment depends upon the strict application of the instructions in this manual.

The VarioTrack charge regulator has a five (5) years warranty (starting from the date of production against material and manufacturing faults. The defective product will be either repaired or replaced at the discretion of Studer Innotec.

2.4.1 Exclusion of warranty

No warranty claims will be accepted for damages resulting from handling, use or treatment that are not explicitly mentioned in this manual. In particular, damages arising from the following causes are excluded from the warranty:

- Voltage higher than 150V across PV or battery terminals.
- Battery reversed polarity across PV input terminals.
- Accidental presence of liquids in the equipment or oxidation due to condensation.
- Damage resulting from falls or mechanical shocks.
- Modifications carried out without the explicit authorisation of Studer Innotec.
- Nuts or screws that have not been tightened sufficiently during the installation or maintenance
- Damage due to atmospheric surge voltage (lightning).
- Damage due to inappropriate transportation or packaging.
- Disappearance of original identification marks.

	Never take off or damage the rating plate showing the serial number. It enables to check and follow-up the data specific to each equipment and is vital for any warranty claim.
---	---

2.4.2 Exclusion of liability

The installation, commissioning, use, maintenance and servicing of the VarioTrack cannot be subject of monitoring by Studer Innotec. Therefore, we disclaim all responsibility and liability for damage, costs or losses resulting from an installation that does not comply with the instructions, a faulty operation or inadequate maintenance. The use of Studer Innotec equipment is in any case under the responsibility of the customer.

This equipment is neither designed nor guaranteed to supply installations used for vital medical care nor any other critical installation entailing potential risks of important damage to people or to the environment.

We assume no responsibility for the infringement of patent rights or other third parties rights resulting from the use of the inverter.

Studer Innotec reserves the right to make any modifications to the product without prior notification.

Studer Innotec is not liable for incidental, direct or indirect damages of any kind, including any profit loss, revenue loss or damages caused to equipment or goods due to defective equipment.

2.5 WARNINGS AND GUIDELINES

The installation and commissioning of the VarioTrack must be entrusted to skilled and qualified personnel perfectly aware of the safety precautions and local rules in force. All elements connected to the VarioTrack must comply with the laws and regulations in force.

	<p>HIGH-VOLTAGE DC INSIDE THE CHARGE REGULATOR: DANGER OF DEATH</p> <p>When the VarioTrack is under operation, it generates voltages that can be potentially lethal (up to 150Vdc). Any work on or close to the installation must be carried out only by thoroughly trained and qualified personnel. Do not try to carry out ordinary maintenance on this product yourself.</p> <p>While working on the electrical installation, it is important to make sure that the source of DC voltage coming from the battery as well as the source of DC voltage coming from the photovoltaic generator, have been disconnected from the electrical installation.</p> <p>Even when the VarioTrack has been disconnected from the power sources, a potentially dangerous voltage may remain at the terminals. To eliminate this you have to wait for at least 120 seconds in order to allow the electronics to discharge. The task can then be carried out safely.</p>
---	--

No person is authorized to proceed with any change, modification or repair of the equipment without the prior written authorisation of Studer Innotec. Use only original parts for any authorised modification or replacement.

Do not exceed the maximum rated characteristics of the equipment shown on the Type label.

	<p>The VarioTrack can be installed at altitudes up to 3000m. For installations at higher altitudes, please contact Studer Innotec SA. The VarioTrack is in overvoltage category II, in accordance with the norm IEC/EN 62109-1:2010 that considers all solar generators as being in overvoltage category II.</p>
---	--

3 MOUNTING AND INSTALLATION

3.1 STORAGE

The equipment must be stored in a dry environment at an ambient temperature between -20°C and 60°C. Store it in the location where it is to be used a minimum of 24 hours before commissioning in order to avoid thermal shocks and condensation problems.

3.2 UNPACKING

When unpacking, check that the VarioTrack has not been damaged during transportation and that all accessories listed below are present. Any fault must be immediately reported to the product distributor or the contact mentioned at the back of this manual.

Check carefully the packaging as well as the VarioTrack.

Standard accessories:

- Installation and operation manual
- Mounting plate
- Cable-glands for battery and PV cables

3.3 MOUNTING PLACE

The mounting place for the VarioTrack is particularly important and must fulfil the following criteria:

- Protected from any unauthorized person.
- In mobile applications, it is important to select a mounting place that ensures no vibration.
- Protected from direct solar radiation or heat sources.

According to the environmental categories defined in the norm IEC/EN 62109-1:2010, the VarioTrack can be mounted in a 3rd degree environment (PD3), which is in a location with dust pollution. The VarioTrack have a high degree of protection (IP-54). However, **do not expose the VarioTrack under direct solar radiation** or near a heat source. The presence of a heat source may reduce significantly its rated power. Similarly, insufficient ventilation may lead to the overheating of some internal components of the equipment. In this case, the device will automatically limit its power as long as this abnormal situation persists.

As far as possible, reduce exposure to sudden temperature variation: important heat variation may create undesired and harmful condensation inside the equipment.

The VarioTrack is electronically protected against overloads, short-circuits, overheating, polarity reversal of the battery, polarity reversal of the PV, connexion of the panels to the battery input and connexion of the batteries to the PV input.

	<p>The casing of the VarioTrack can reach temperatures slightly higher than 60°C when used for a long period at maximum performance. This high temperature can last several minutes after the equipment has been turned off. It should be installed in a restricted access area, away from children or any unauthorized person.</p>
---	---

3.4 FIXING / DIMENSIONS

	<p>The VarioTrack is a heavy equipment (~5kg) and must be mounted to a support (wall) designed to bear such a load. It is imperative to ensure a complete and safe fastening of the equipment. If simply hung, it may fall down and cause severe damages.</p>
---	---

The VarioTrack must be installed vertically. A distance of at least 5cm between the units and/or 20cm around the equipment is required to guarantee adequate ventilation.

If the VarioTrack is installed in a closed cabinet, it must have a sufficient ventilation to guarantee that the ambient temperature is kept within the operating limits of the VarioTrack.

In motor vehicles, or when the support undergoes significant vibrations, the VarioTrack is to be mounted on anti-vibration elements.

The VarioTrack enclosure is fitted with a support plate to be mounted on the back of the case using 4 screws M6, 8 mm long, and washers (see fig. hereafter), before wall mounting. Mount it vertically with the cable-glands downward.

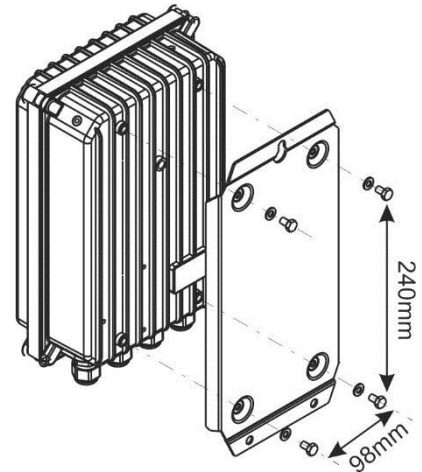

An external cooling fan (ECF-01) can be installed before or after the equipment has been mounted on the wall in order to improve its performances.

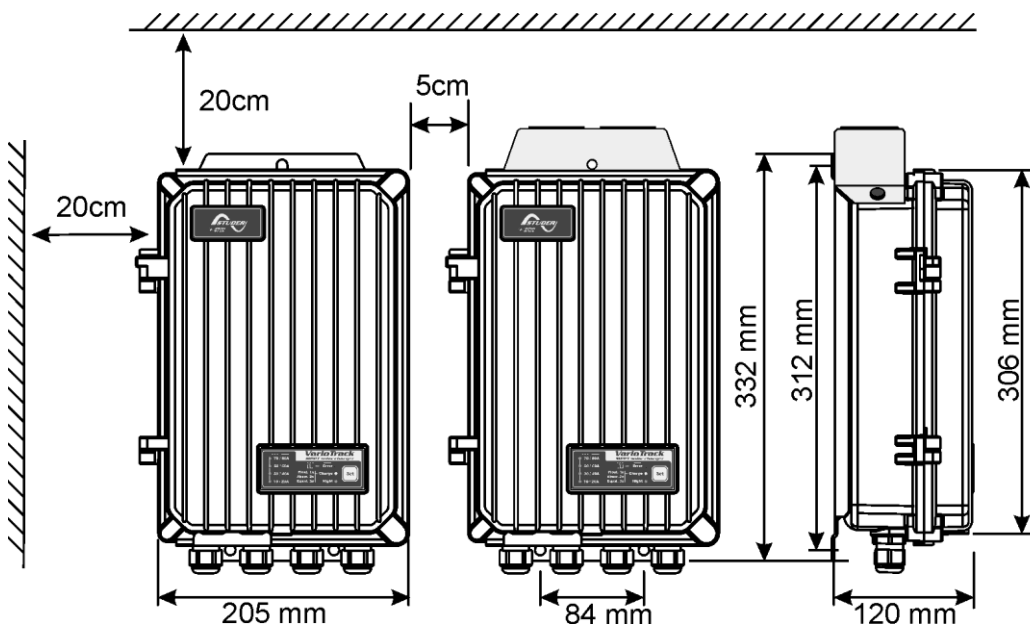



3.4.1 Assembling the cooling fan (model VT-80)

The VarioTrack having the reference VT-80 is supplied with an external cooling fan module (ECF-01). This module can be installed before or after mounting the VarioTrack on the wall (see also chap. 9.4 - p. 42).

4 WIRING

	<p>The connection of the VarioTrack charger is an important step of the installation. It may only be carried out by qualified personnel, aware of the rules and regulations in force. The installation must always comply with these standards. The cross-sections of the cables connected to its terminals must comply with local regulations. All cables in use should be isolated with PVC, TFE, PTFE, FEP, neoprene or polyimide.</p> <p>Make sure that connections are completely tightened and that each wire is connected at the right place.</p>
---	--

	<p>The VarioTrack is intended to be connected exclusively to a source like a photovoltaic generator, excluding any other energy source.</p> <p>It is suitable for charging any type of lead-acid batteries. It is often possible to charge any other type of battery using proper settings and with the express approval of the battery supplier.</p>
---	---

	<p>The connection compartment of the VarioTrack must remain permanently closed while the apparatus is operating.</p> <p>Before opening, check that <u>all</u> voltage sources (battery and PV) have been disconnected or switched off and wait for at least 2 minutes before opening the equipment. It is imperative to close the protection cover on the connection terminals after each servicing.</p>
---	--

4.1 ELEMENTS OF THE CABLE COMPARTMENT

No.	Description	Comments
1	Terminal to connect the battery positive pole	This connection must be done using a protection and disconnection device if the pole has not been earthed.
2	Terminal to connect the battery negative pole	This connection must be done using a protection and disconnection device if the pole has not been earthed.
3	Terminal to connect the solar generator negative pole	The solar generator wiring must be carried out in compliance with the voltage and current limits mentioned on the rating plate.
4	Terminal to connect the solar generator positive pole	
5	Input protection fuse	Fuse 4 x 30A / 80V or fuse 1 x 100A/80V. See sect. 4.4.4.1.
6	Socket for BTS-01 (battery temperature sensor) and ARM-02 (auxiliary relay module) accessories	Only the mentioned original accessories can be connected to this connector. See chap. 9 & 10.
7	Socket for communication cables	RJ45 connector used for connecting equipment of the Xtender family. These connections must be carried out only with original Studer cables.
8	Termination switch	The switch must be placed in position O (towards (9) when both connectors (7) are used).
9	Configuration switches	The various possible configurations are described in sect. 8.1.
10	Real-time clock battery (type CR 2032)	The equipment is fitted with a battery lasting about 10 years.
11	Screw to close the front cover	These screws should be tightened to a torque of 5Nm to guarantee the IP rating of the VarioTrack.

4.2 CONNECTION COMPARTMENT

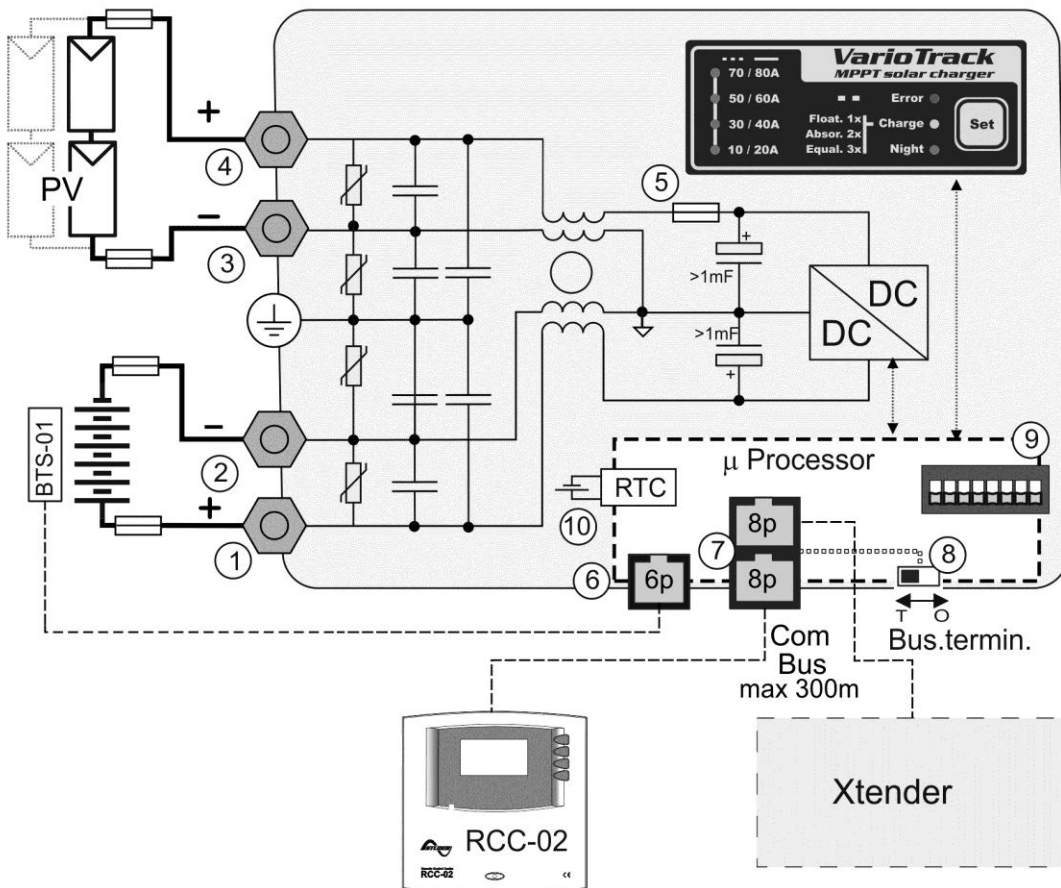
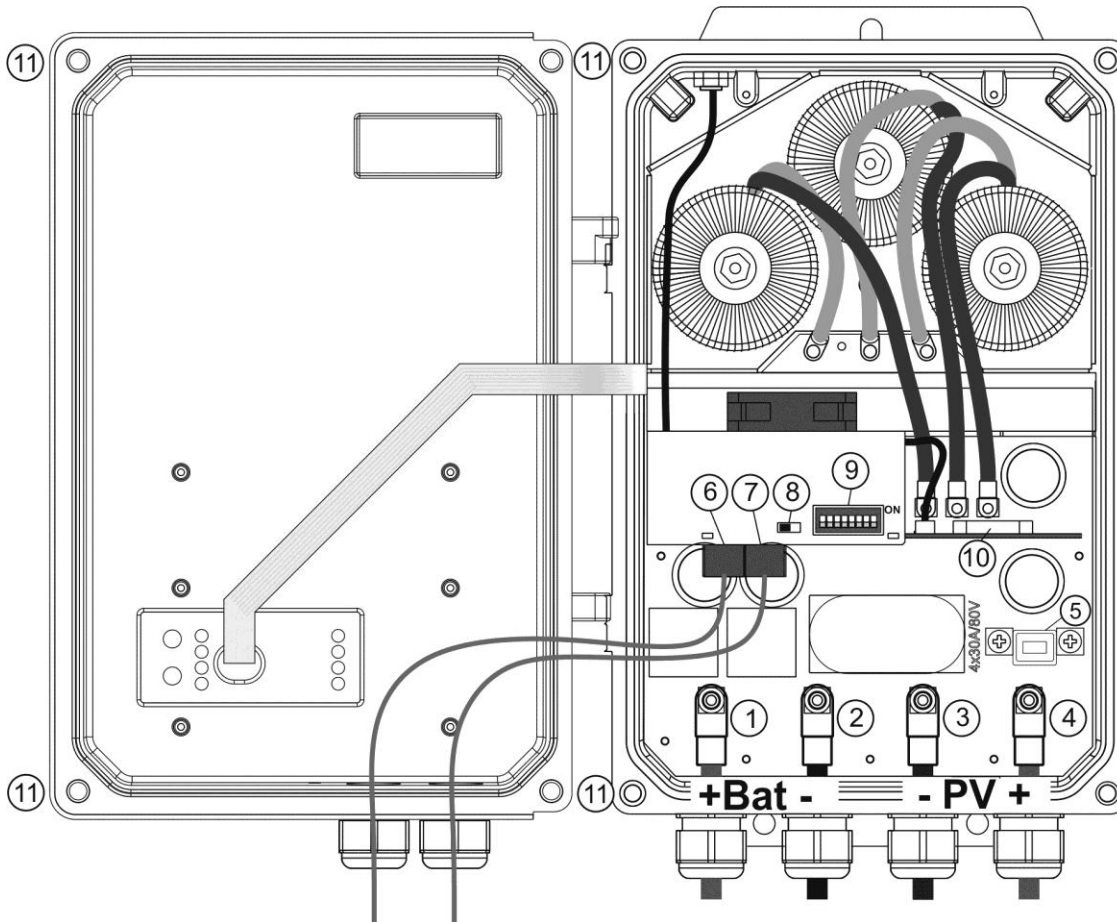

4.3 PHOTOVOLTAIC GENERATOR (PV)

The VarioTrack may accept input voltages between 0 to 150V max. Its operating range as a charger starts from a value above the battery voltage up to 145V.



If the no-load voltage of the panel is above 75V (in all the temperature range), the whole solar system must be installed according to protection class II.

4.3.1 Dimensioning

The solar generator is dimensioned to cover an important part or the entire power requirement of the system. Once the power has been decided upon, it will be distributed among one or more solar charge regulators, wisely combining the modules among them. These combinations in series and in parallel must be carried out according to the voltage and current limits of the VarioTrack regulator.

4.3.2 Serial connection (string) of PV modules

To get the optimum voltage, the PV modules shall be connected in series to form a string having the desired voltage. The optimum operating voltage of the module string (Umpp) must always be above the battery voltage. To establish the **minimum** number of PV modules to be connected in series in the same string, the max voltage of the battery must be multiplied by 1.1 and divided by the modules Vmpp voltage.

For example, for a system with a VLA type lead-acid battery supporting equalization at 60V: $60 \times 1.2 / 17 = 4.2$.

The result must be **rounded up to the highest value** (i.e. 5 modules - of 17 Umpp - in series for the above example).

The open-circuit voltage of the string must be lower than 150V under any temperature and irradiation conditions. A 10 to 20% margin is recommended in order to cover these unknowns.

To establish the maximum numbers of the PV modules connected in series in the same string, use the following formula: $150V / (U_{oc} \times 1.1)$. (Example: $150 / (22 \times 1.1) = 6.2$). The result must be **rounded down to the lowest value** (i.e. 6 modules - of 22 Voc - in series for the above example).

There should be thus 5 or 6 PV modules in series of the mentioned model for a 48V system as per this example.

The table hereunder gives an idea of the possible arrangements for common panels according to the number of cells or their type:

U Battery	36 cell module Voc < 23V		60 cell module Voc < 37V		72 cell module Voc < 45V		96 cell module Voc < 66V		Thin layer module Voc > 80V	Number of modules per string
	max.	opt.	max.	opt.	max.	opt.	max.	opt.	--	
12V	3	2	2	1	1	1	1	1	0	
24V	6	3	3	2	3	2	2	1	1	
48V	6	5	3	3	3	3	2	2	1	

Beware of the PV module temperature! The above values are for modules under standard test condition (STC).

4.3.3 Parallel connection of PV module strings

To get the required charging power, 2 or more strings are usually to be connected in parallel. Each string connected in parallel shall be composed by the same number of modules of the same type.

The number of strings connected in parallel depends on the power of each module. The sum of the power of all the panels connected to a VarioTrack should not exceed the power that the VarioTrack can charge, see table to the right.

Maximum recommended power for the solar generator

Battery	VT-65	VT-80
12V	1000W	1250W
24V	2000W	2500W
48V	4000W	5000W

The number of strings to be connected in parallel must not exceed the maximum power (see table hereafter) divided by the power of a string and rounded down to the lower value.

For example, in a 48V system with strings composed of 5 in-series modules of 110W connected to model VT-65: $4000 / 550 = 7.3 \Rightarrow 7$ strings (3850W) can be put in parallel.

These strings of 5 modules in series may become 9 when connected to model VT-80.

If the maximum currents mentioned in chap. 4.3.3.1 are respected, the PV generator can be over-dimensioned in order to get the required charging power even when solar irradiation is lower. In this case, a part of the energy will be lost when the solar irradiation is higher.

Note: the VarioTrack has a current limit. The maximum power of the VarioTrack depends on the charging phase voltage of the battery.

4.3.3.1 Maximum current of the solar generator

The maximum current of the solar generator (sum of the short-circuit currents for all the strings connected in parallel) is 60A for model VT-65 and 75A for model VT-80.

	Note: the National Electrical Code (NEC) in force in the United States requires a limit of the solar generator current $\leq 0.8 \times$ rated current of the solar regulator. Thus in order to comply with NEC, the maximum current for the solar generator is 52A for the VarioTrack model VT-65 and 64A for model VT-80.
---	--

In any case, the VarioTrack will limit the charging current (battery) to its rated current, i.e. 65A for model VT-65 and 80A for model VT-80.

4.3.4 Safe use of the photovoltaic modules

	The VarioTrack is meant for PV generators supplying up to 150Vdc. This voltage is dangerous for human beings. During the installation or the maintenance of the system, it is imperative to make sure that no dangerous voltage may surge in the system. The disconnection device must be open and secured against any accidental reclosing.
---	---

4.3.5 Protection devices

Wiring protection devices (fuses, circuit breakers) connecting the PV generator to the VarioTrack must be installed in accordance with local standards and regulations in force.

The DIN VDE 0100-712 standard prescribes a switching device on all poles between the PV generator and the charge regulator. This device must be supplied by the installer.

PV modules are often exposed to stormy weather. It is highly recommended to install lightning protection (see chap. 4.7).

4.3.6 Cable cross-section

The connection cable cross-section must be chosen according to the short-circuit current of the PV generator and the local installation rules. A 25mm² cross-section is recommended.

Terminals (M6) must be tightened at a torque of 5 Nm.

All connection cables as well as the PV cables must be mounted using cable restraints in order to avoid any pulling on the connection.

4.3.7 Parallel connection of several VarioTracks

As many VarioTrack as necessary could be connected in parallel on the same battery bank according to the battery capacity. Each will have its own independent solar generator and is connected with its own disconnection and protection device to the battery.

Up to 15 VarioTrack could be synchronized and interconnected to the same communication bus (see chap. 4.8) on a single system. Beyond these 15 units, any additional unit will not be interconnected and thus their battery cycles will work independently.



If several VarioTrack units are connected together by the communication bus, it is highly recommended to make a software update of all components in the system to guarantee all its functionalities. (see chap. 9.1 - p. 40)

Solar generators may be of various types and be orientated differently. Each VarioTrack will adjust the optimum point of the PV generator independently of the other units connected to the same battery.



Under no circumstances should PV module inputs of several VarioTrack be put in parallel.



In multi-unit systems (connected to the same communication bus), all VarioTracks must be connected to the same battery bank.



When the VarioTrack units are not synchronized, they must be programmed in the same way and it's recommended to not activate the periodical equalization function. The equalization can be manually started or will be done by the synchronized units.



In multi-unit systems, each VarioTrack is connected to the common battery using its own protection device. All other consumers or sources are connected directly to the battery using their own protection device.

4.4 CONNECTING THE BATTERY

The VarioTrack is a device which DC (battery) connection is to be connected exclusively to a battery. Most of the time, lead-acid batteries with liquid (VLA, VRLA) or gelled (GEL) and AGM electrolyte may be used. It can be easily configured to create charge profiles that are compatible with these various types of lead-acid batteries.



The use of other battery types like Ni-Cd, Li-ion or other is possible if the charge profile is properly programmed, in accordance with the specifications of the battery manufacturer, in agreement with the battery manufacturer and under the responsibility of the installer.



The use of the VarioTrack connected to any other type of DC source without battery (buffer) is strictly forbidden and may cause significant damage to the equipment and / or to the source.

4.4.1 Dimensioning the battery

The battery bank is dimensioned depending on the user's daily power consumption and the number of days of autonomy required. It is dimensioned in order to reduce the daily discharge depth as well.

In any case, the battery bank must be dimensioned in order to reach a reasonable ratio between the maximum charging current and the battery capacity. As for lead-acid batteries, the charging current should be between 0.1 and 0.2 x C_{batt} [Ah] (C10) in order to ensure an optimum charge. For a 65A charger, a battery of at least between 350 and 700Ah is necessary.

The dimensioning of the battery must also take into account the power and the type of charge that are connected, most often an inverter. For this type of charge, the minimum capacity of the battery bank (in Ah) may be calculated this way: five times the inverter rated power divided by the battery voltage. For example, an Xtender XTH 8000-48 inverter/charger should have a battery capacity of a minimum $7000 \cdot 5 / 48 = 730$ Ah (C 10). Due to the extreme overload capacity of the inverter, it is often recommended that this value be rounded up. An under-dimensioned battery may lead to an

accidental and undesired stopping of the inverter in case of high demand. This stopping is due to an insufficient voltage of the battery subjected to a strong discharge current.

Choose the battery according to the greatest value resulting from the calculation suggested above.



The wiring and connection of the installation must be carried out only by perfectly qualified personnel. The installation material such as cables, connectors, distribution boxes, fuses, etc., must be appropriate and comply with the laws and regulations in force for the application in question.

4.4.2 Precautions when using the batteries

The batteries should only be chosen, dimensioned and installed by qualified personnel, trained in this specific area.

Lead-acid batteries with liquid or gelled electrolyte produce a highly explosive gas during normal use. Avoid source of sparks or fire in the immediate vicinity of the batteries. The batteries must be kept in a well-ventilated place and installed so as to avoid accidental short-circuits when connecting.

Never try to charge frozen batteries. When working with batteries, a second person is required in order to give assistance in case of problems.

Sufficient fresh water and soap must be kept close at hand to allow adequate and immediate washing of the skin or eyes affected by accidental contact with the battery acid. In the event of accidental contact of the eyes with acid, they must be washed carefully with cold water for 15 minutes. Then immediately consult a doctor.

The battery acid can be neutralized with baking soda, among other things. A sufficient quantity of baking soda should be available for this purpose.

Particular care is required when working close to the batteries with metal tools. Tools such as screwdrivers, open-ended spanners, etc., may cause short circuits. Sparks created by short-circuits may cause the battery to explode. Therefore these kinds of tools must always have isolated handles and never be placed on top of a battery. When working with the batteries, all metal jewellery such as rings, watches with a metal bracelet, earrings, etc., must be taken off. The current supplied by the batteries during a short circuit is sufficiently powerful to melt the metal and cause severe burns.

Batteries at the end of their life-cycle should be recycled in accordance with directives from the responsible local authorities or the battery supplier. The batteries should never be thrown into fire as they may explode. Under no circumstances should you try to take apart or dismount the battery, as they contain toxic and polluting materials. For ungrounded battery systems, always check that they are not inadvertently grounded before starting working on the batteries.

Always follow carefully the instructions of the battery manufacturer.

If the battery voltage exceeds the value of 17/34/68V, the charger turns off and starts again when the voltage is lower than 16/32/64V.



A battery voltage higher than 80V can cause important damage or destroy the equipment. Such a voltage applied on equipment connected downstream like Xtender inverters/chargers or other, can cause important damage or destroy the equipment!

4.4.3 Connecting the battery

All connection cables as well as the battery cables must be mounted using cable restraints in order to avoid any pulling on the connection.

Battery cables must also be as short as possible and the cross-section must comply with the regulations and standards in force. Tighten the clamps on the "Battery" inputs sufficiently.



Each VarioTrack is connected directly to the battery using its own protective device. All other consumers or sources are connected directly to the battery through their own protective device.

Lead batteries are usually available in 2V, 6V or 12V blocks. In most cases, in order to get the correct operating voltage for using the VarioTrack (12, 24 or 48V), several batteries must be connected in series. The capacity of the batteries can be increased using a parallel connection of several battery strings.

Some battery manufacturers limit the use or advice against parallel connection of battery strings. Strictly conform to the manufacturer's instructions of use.

 In multi-unit systems (connected to the same communication bus), all VarioTracks must be connected to the same battery bank.

4.4.4 Protection device of the battery

The battery cables must also be as short as possible. The recommended cable cross-section is 25mm² and the protection devices (battery side) must be of 80A for model **VT-65** and 100A for model **VT-80**. The protection device must be installed as close as possible to the battery. The recommended cross-section is valid for lengths up to 3m. Beyond this length, it is recommended to oversize the section of the battery cables.

Any other sources or loads existing on the battery must be connected using their own protection devices. Never connect them to the protection device(s) of the VarioTrack.

4.4.4.1 Internal fuse

The VarioTrack has an internal fuse only on the positive terminal of the PV connection. This device protects the equipment against short-circuits on the PV side when the equipment is operating (charging) and against a battery connection error.

A broken internal fuse is a sign of a major fault in the wiring: most probably either a short circuit on the solar generator side or a reverse battery connection on the solar input! Before replacing the internal fuse, make sure that the solar generator is disconnected from the VarioTrack. The fuse may consist of 4 car fuses 30A/80V or be one single blade fuse 100A/80V given the version of the PCB you have. These fuses should be replaced by fuses of the same type (Littlefuse or Pudenz FKS 166.7000.530 or equivalent for the 4 car fuses; Pudenz 156.5611.6101 or equivalent for the blade fuse.

This operation must be carried out by qualified personnel. In case of doubt, the equipment must be returned to the supplier for a check (this fault is not covered by the warranty).

 An annual check of all the connection tightness is recommended. In mobile installations, the connection tightness should be checked more often.

 Battery cables must always be protected by one of the following measures:

- Have a protection and disconnection device (fuse, circuit breaker) on each pole or only on the pole not connected to earth.
- The protection device must be rated according to the cable cross-section but must not exceed 1.25 x VarioTrack maximum current. It will be mounted as close as possible to the battery.

4.5 MULTI-UNIT CONFIGURATIONS

Several interconnected VarioTrack units (See chap. 4.3.7) may be used on the same battery to create a high power charger. In multi-unit systems, the units are interconnected (max.15 units) via a communication bus (see chap. 4.8) that uses the connectors (7) and a cable (ref. CAB-RJ45-2) that is maximum 5 metres long. When both connectors (7) are used, the termination selector (8) must be in O (open) position.

 If a VarioTrack is connected to another compatible device (Xtender, VarioTrack, VarioString, BSP, RCC, Xcom) with the same communication bus, it is highly recommended to make a software update of all components in the system in order to guarantee all functionalities.

 In multi-unit systems, the charge is synchronized (up to 15 units) and the battery bank is common. Each VarioTrack will be independently connected to his own solar generator without any connection to the other PV generator connected to other VarioTrack.

When they are interconnected by means of the communication cable, the VarioTracks synchronize automatically in order to get a coherent battery cycle. This synchronisation can be deactivated using a parameter.

 When the devices are in the voltage regulation phase, their currents current may considerably differ. These differences have no effect at all on the charge quality.

 During the commissioning of the equipment in a multi-unit configuration, the system checks automatically the compatibility of the software versions and may prevent the operation in case of incompatibility. An upgrade of the installation must then be carried out by means of the RCC-02/-03 remote control using the latest manufacturer's software version (read the user manual for the control and monitoring unit RCC-02/03 to carry out this operation).

4.5.1 Extension of an existing installation

In interconnected installations, if the software is compatible, it is possible to extend an existing installation by adding one or several (up to 15) VarioTrack units in parallel. The compatibility of the new units can be checked by Studer Innotec if the serial numbers of the equipment of the existing installation are provided.

 Equipment belonging to the same system must be equipped with the same software version. Download the latest software version from the manufacturer's website and update the software for all units of the system before commissioning.

4.6 EARTHING GUIDELINES

The VarioTrack is a Class I protection equipment, its metal case must be earthed by means of the screw provided between the cable gland.

 = protective earth (connected to the enclosure of the equipment).

Inside the equipment, the negative poles of the battery and of the PV are in common. For security's sake, the VarioTrack requires the negative pole to be earthed. The solar generator (as well as its wiring) must be Class II isolated.

All the other earthing systems (earthing by means of a protection device, impedance, without earthing (IT) or earthed at positive pole) require the whole battery circuit to be protected against electric shocks.

Any accidental contact with the conductive parts of the battery circuit is to be avoided by providing a Class II protection level.

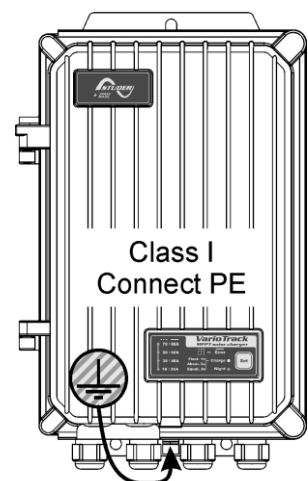

 If the no-load voltage of the panel is above 75V (in all the temperature range), the whole solar system must be installed according to protection class II.

The cross-section of the earthed cable must not be lower than 16mm².

In any case, the protective earth must be connected in accordance with local standards and regulations in force. The protective earth of the equipment must be connected at least to the protective earths of all the Class I equipment after and before the VarioTrack (equipotential connection). The information, notes, recommendations and diagrams reported in this manual are in any case subject to local installation rules. The installer is responsible for the conformity of the installation with the local standards in force.

	Do not connect the positive pole of the solar generator to the earth otherwise dangerous voltages will surge between the battery poles and the earth.
---	---

4.6.1 Detection of earth fault

Choosing how to earth the DC circuit is an important factor for the user's safety. Once the choice is made, the VarioTrack can check the continuity or, on the contrary, the failure of the earth connection (in the case of an IT system).

In case of failure of the earth connection, the equipment turns off and the LED (3) lights up indicating a fault. A permanent message (requiring validation) is displayed on the RCC if present.

The parameter {10060} establishes the type of earth fault check to be carried out.

The earth fault check can be set to one of the following three types of earthing schemes, or deactivated:

Negative pole earthed: In the VarioTrack the negative poles of the PV modules as well as the battery are connected. If this option is chosen, the VarioTrack constantly measures the voltage between the earth and the negative poles. If the measured voltage is greater than approximately 1V, the VarioTrack registers an error.

Battery positive pole earthed: The VarioTrack constantly measures the voltage between the positive pole of the battery and the earth. If this voltage is greater than approximately 1V, the VarioTrack registers an error.

Floating battery: This option should be used when none of the poles is connected to the earth. In this case, the VarioTrack measures the voltage between the battery positive pole and the earth and voltage between the battery negative pole and the earth. If one of the voltages is less than 1V, the VarioTrack registers an error.

4.7 LIGHTNING PROTECTION

The VarioTrack has internal protections against lightning by means of surge protection devices. These devices have an energy dissipation capacity limited to 3,5kA (8x20 μs) which guarantees a certain protection level but are not a total protection against lightning. According to the installation site, it is highly recommended to develop a protection strategy specific to your installation. The strategies depend on various factors specific to each site; we recommend therefore a professional approach to this issue.

	Most of the time, damages due to lightning generate significant costs (replacement of all the electronics) which are not covered by the manufacturer's warranty.
---	--

4.8 CONNECTING THE COMMUNICATION CABLES

	The connection compartment of the VarioTrack must remain permanently closed while operating. Before opening, check that <u>all</u> voltage sources (battery and PV) have been disconnected or switched off and wait for at least 1 minute before opening the equipment. It is imperative to close the protection cover on the connection terminals after each servicing.
---	--

The VarioTrack is fitted with 2 connectors RJ45/8 (7) (see chap. 4.1 – p.10) that enable to transfer information via a communication bus to other VarioTracks or to other equipment such as the RCC or the BSP having the proprietary protocol of Studer Innotec (see chap. 9). All the units in the network are connected in series (strings).

	The termination switch of the communication bus "Com. Bus" (7) remains in position T (terminated) except when both connectors are used. In this case and only in this case, the switch must be placed in the O (open) position. If one of the two connectors is not used, the termination switch (7) will be in position T.
---	---

The max accumulated length of the communication bus is 300m. Due to a line voltage drop, it is recommended to install only one RCC module at the end of a 300m line or a max of 2 modules at the end of a 150m line. All the other modules of the system must be placed within the same radius of a few meters (technical room).

	<p>A maximum of 2 RCC-02/-03 or Xcom-232i may be connected to the same communication line with a VarioTrack. For more information, refer to the RCC-02/-03 or Xcom-232i manuals available on our website at the following address: www.studer-innotec.com/support</p>
---	---

The communication bus will be used to interconnect other VarioTrack chargers in the case of a multi-unit application or to connect other types of users who have Studer Innotec's proprietary protocol (Xtender, BSP). In these cases, the installation must be switched off and de-energized in order to interconnect the units on the communication bus.

	<p>If a VarioString is connected to another compatible device (Xtender, VarioTrack, BSP, RCC, Xcom) with the same communication bus, it is highly recommended to make a software update of all components in the system in order to guarantee all functionalities.</p>
---	--

The RCC-02/03 or Xcom-232i should not be placed between two devices connected to the battery (Xtender, VarioTrack, or VarioString).

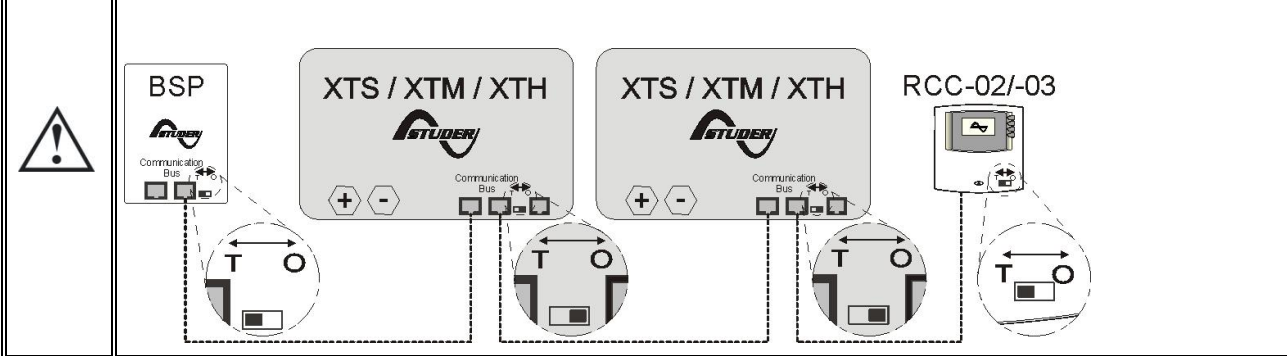

5 POWER-UP OF THE EQUIPMENT

	<p>It is imperative that the closing cover for the connection compartment is installed and screwed tight before energizing the installation. There are dangerous voltages inside the cable compartment.</p> <p>If special configurations or settings are required for the system and they are set via internal buttons or switches (DIP switch, see chap. 8.1), they should be set before connecting the PV modules.</p>
---	--

The connection of the VarioTrack must be carried out in the following order. Any disassembly shall be carried out in the reverse order. Before closing the protections and energizing the equipment, check the polarity.

- A. Connecting the battery: on the BAT+ and BAT- terminals
 - Check that the VarioTrack switches on.
 - If there is an RCC-02/-03 during commissioning:
 - check that the battery voltage is displayed correctly
 - check that the type of installation is correctly recognized (12/24/48V)
- B. Connecting the photovoltaic panels: on the PV+ and PV- terminals
 - Check the PV voltage seen on the RCC.
 - Check the operation of the charger and the effective charging of the batteries when it is sunny.

Your installation is now in operation. If the system requires specific configurations or settings, carry them out immediately. Settings must be programmed by means of the remote control RCC-02/-03 as per chap. 8.2 or by means of the internal DIP switches as per chap. 8.1.

If the equipment seems to have an incorrect behaviour, the table hereunder shows some wiring errors and the symptoms related to them.

5.1.1 Wiring errors and their symptoms

Wiring error	Notification on the VarioTrack	Indication on the RCC-02/-03 remote control	Symptom / Action to be taken, correction to be made
Polarity reversal of the solar generator on its input	LED "Night" (1) lit	No PV voltage displayed on the RCC	Check and correct the wiring error
Polarity reversal of the battery on the battery input	LED "error" (3) flashes 7x	Message 80 (see p. 28)	Check and correct the wiring error
The battery is connected to the solar input	No indication	If no battery on the input: => Message 80 (see p. 28)	Check and correct the wiring error
Reverse connection of the battery to the solar input	No indication	The equipment does not switch on. The internal protection fuse is broken and must be replaced by qualified personnel. The wiring must be corrected. The equipment functionalities must be checked.	
The solar generator is connected to the battery input	LED "error" (3) flashes 4 times	Message 20 (see p. 28)	Acknowledge the message and correct the wiring error
Reverse connection of the solar generator to the battery input	LED "Night" (1) lit	No PV voltage displayed on the RCC	Check and correct the wiring error
The battery is not connected and there is an active solar generator	LED "error" (3) flashes 7 times	Message 80 (see p. 28)	Acknowledge the message and correct the wiring error.
Battery with inactive solar generator, not connected or defective:	LED "error" (3) flashes 6 times	Message 83 (see p. 28)	The battery has not been charging for more than 48h. Check the protection devices, the wiring of your solar generator or clear the persistent shade (snow)
Voltage of the PV generator too high	LED "error" (3) flashes 5 times	Message 82 (see p. 28)	Check the PV wiring (see chap. 4.3.2) Caution: A voltage higher than 150V can seriously damage the device.

	<p>If the VarioTrack has been accidentally connected the wrong way (battery reverse polarity on the panel input), it is likely that the protection device on the battery cables is open. In such case, recheck carefully the battery polarity, the wiring and the internal fuse of the VarioTrack that protects against this situation. If after having closed or replaced the protection device (f), the VarioTrack still does not work despite the correct polarity and voltage of the battery, it must be brought back to the Seller for repair.</p>
---	---

6 DISPLAY SYSTEM

The VarioTrack is fitted with a "Set" button and light indicators on the front of the equipment allowing a clear identification of the operating mode.

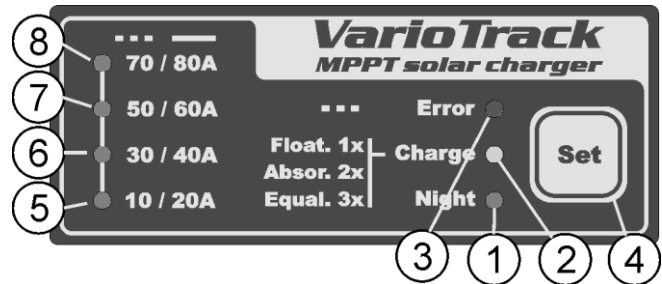

6.1 THE "SET" BUTTON (4)

The "Set" button can be used to start manually an equalization cycle if this phase is authorized by the initial settings of the equipment. The equalization phase will be authorized as from the beep after having pressed the "Set" button (4) for 2 seconds. The "Charge" light indicator flashes 3x as long as the equalization phase is not completed. The equalization can be interrupted by pressing a second time for 2 seconds: a double beep indicates that the function has been cancelled. The indicator (2) stops flashing 3x confirming the cancellation.

Pressing the "Set" button (4) for 5 seconds until the second beep turns off the VarioTrack. It starts again by pressing the "Set" button for 5 seconds.



When the VarioTrack(s) are connected to an Xtender system and the synchronization {10037} is activated, the manual equalization can be started only during the battery cycle of the Xtender which will then pilot the VarioTrack to carry out an equalization phase. In "synchronized" mode, the cycle state - floating, absorption, equalization - are indicated. The "charge" LED (2) and the indicator for the amount of charge are used when the equipment is operating.

6.2 "NIGHT" STANDBY INDICATOR (1)

This green indicator lights up when the VarioTrack is connected to a battery and ready to operate but there is no PV voltage (at night or when no PV module is connected) or it is too low (inferior to the battery voltage). This indicator flashes when there is a PV voltage but it is insufficient to charge the batteries (at the beginning or at the end of the day). In order to save the battery power, the VarioTrack charger turns off and goes in standby mode when this indicator lights up or flashes. It will then consume less than 1W. The charger automatically switches on again when the sun starts shining and PV voltage goes back above the battery voltage.

6.3 "CHARGE" CYCLE INDICATOR (2)

This yellow indicator lights up when the sun is shining and the photovoltaic generator produces enough voltage for charging the batteries. Various flashing modes enable to distinguish what phase the regulator is in. This indicator lights up continuously during the bulk phase. It flashes 1x during the floating phase, 2x during the absorption phase and 3x during the equalization phase.

In "synchronized" mode, the cycle state - bulk, floating, absorption, equalization - are indicated.

6.4 "ERROR" INDICATOR (3)

The table hereunder describes the type of error according to the number of times this indicator flashes.

Indic.	Indicated error	Comment	No.
Off	No problem	If no indicator lights up, the equipment is de-energized.	01
On	The equipment is OFF	The equipment is energized but it does not operate because of a user command (the "Set" button has been pressed for 5s).	02
Flashes 1x	Battery low voltage warning	The equipment is still operating but shows that the battery is lower than 10/20/40V.	03
Flashes 2x	Earth fault	The VarioTrack detects an abnormal situation which does not correspond to the programmed value of the parameter {10060} checking the state of the earth connection. The VarioTrack turns off. It automatically starts again when the normal situation is restored.	04
Flashes 3x	Power reduction or stop due to an excessive temperature in the equipment.	This may be due to an excessive ambient temperature, exposure of the equipment to a heat source (sun) or to deficient or impeded ventilation.	05
Flashes 4x	Battery voltage higher than 17/34/68V	Check the cause of this excessive voltage. The equipment automatically starts again when voltage returns to a value lower than 17/34/68V.	06
Flashes 5x	The PV voltage is higher than the set value of the max operating limit.	The PV voltage exceeds the max limit of 145V (75V when battery is 12V). The equipment will stop or won't start.	07
Flashes 6x	No voltage has been detected for 48h.	The PV generator is probably disconnected. Check the protection devices (fuse or circuit breaker) and/or check the wiring. As a last resort, after making sure that the PV generator is disconnected, check the internal fuse (5)*	08
Flashes 7x	Battery fault	Missing battery, polarity reversal or voltage lower than 7V.	09
Flashes 8x	Software incompatibility in a multi-inverter system.	The different parts of the system's equipment must have the same software version to function properly. Proceed with the update following the procedure in manual RCC-02/-03.	10

* If the internal fuse is broken, this shows a major error in your wiring: most probably either a short circuit on the generator side, either a reverse connection of the battery on the solar input! In such case, check carefully the operation of the equipment after the error has been corrected. The fuse may consist of 4 car fuses 30A/80V or be one single blade fuse 100A/80V given the version of the PCB you have. These fuses should be replaced by fuses of the same type (Littlefuse or Pudenz FKS 166.7000.530 or equivalent for the 4 car fuses; Pudenz 156.5611.6101 or equivalent for the blade fuse. This operation must be carried out by qualified personnel. In case of doubt, the equipment must be returned to the supplier for a check (this fault is not covered by the warranty).

6.5 CHARGING CURRENT INDICATOR (5)-(6)-(7)-(8)

These indicators flash or light up continuously to indicate the current charging range as per the table to the right.

The RCC-02/03 remote control allows a complete and detailed display of the VarioTrack behaviour (see. chap. 9.1).

Flashing indicator	Indicator number	Lit up indicator
60-70A	LED (8)	70-80A
40-50A	LED (7)	50-60A
20-30A	LED (6)	30-40A
0-10A	LED (5)	10-20A

7 BATTERY CHARGING PROCESS

7.1 GENERAL POINTS

The VarioTrack has many parameters that can be modified by the user or the installer in order to adapt the equipment to the energy system the best possible way. The factory values of these parameters are reported in the table at the end of this manual.

These parameters can be modified by means of the remote control RCC-02/03 (optional) (see chap. 9.1– p. 40) and for some of them, a basic configuration can be done using the DIP switches (9) inside the equipment (see chap. 8.1).

7.2 BATTERY CYCLE

The VarioTrack is a fully automatic solar charge regulator designed to guarantee an optimum charge for most lead/liquid acid, lead/gel or AGM batteries. The battery charger enters automatically into operation as soon as the irradiation is sufficient and the photovoltaic panel voltage is higher than the battery voltage. The "Charge" indicator (2) lights up or flashes depending on the on-going charging phase.

The batteries can be fully charged by the successive phases 1 to 4 described hereunder.

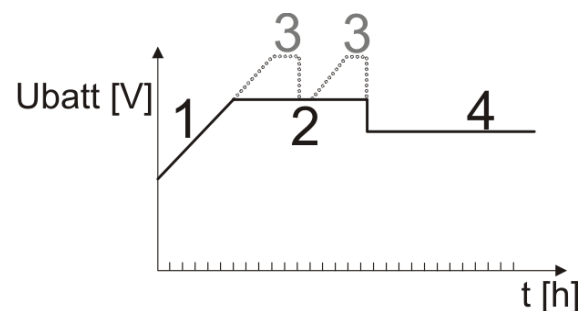

7.2.1 Bulk phase

The bulk phase is the stage when the voltage of the battery rises thanks to the maximum available current produced by the photovoltaic generator depending on the irradiation at the time. It is limited to a maximum of 65A for model VT-65, or to 80A for model VT-80 (a VT-65 fitted with the external cooling fan ECF-01). It is important that the max battery charge current be set according to the battery specifications to prevent damaging them. This current can be limited with parameter {10002} "maximum output current". It is possible that these currents are not reached if the generator power is not sufficient because of its dimensioning, solar power, silicon temperature (crystalline cell), or because the ambient temperature is excessive (or the ventilation is insufficient).

7.2.2 Absorption phase

This charging phase, of a limited duration {10011}, allows the battery to absorb a maximum of power while limiting its voltage {10009}. As soon as this absorption voltage is reached, the duration of the phase is counted down as long as the voltage remains higher than the floating phase {10005}. If the charging current is lower than 4A {10013} whereas the voltage limit is reached, the absorption phase is considered finished. The end of the absorption triggered by the current {10012} can be disabled if necessary.

The absorption phase can be disabled by parameter {10008}. The maximum voltage that can be reached will be the floating voltage {10005}. It is the case when charging a Li-Ion battery.

7.2.3 Floating phase

When the battery is completely charged, a constant reduced voltage {10005} is applied on the battery. This voltage prevents self-discharge and keeps the battery at its maximum charge level and reduces to the minimum the water evaporation that would occur at a higher voltage.

7.2.4 Equalization phase

This phase is allowed {10017} only for open batteries with liquid electrolyte. During this phase, the set voltage limit for the battery is temporarily {10022} higher. It allows on one hand to equalize the electrolyte density through mixing (corrosion control) and on the other hand to equalize the charge among the cells of the battery. During this phase, the charging current can be limited by parameter {10020}.

When authorized, the equalization phase is carried out at fixed intervals {10052} before the absorption phase. The equalization phase may be applied after the absorption phase by modifying parameter {10019}.

By default, equalization is forbidden because it is incompatible with gel or AGM type batteries. It may be authorized by parameter {10017}. The equalization can also be authorized depending on the setting of the DIP switch inside of the equipment (see chap. 8.1).

 The default battery cycle is suitable for a large number of batteries, whether gel or not, because the equalization phase is not activated.

When this phase is authorized, it can be started manually by pressing for 2 seconds the "SET" button on the front of the VarioTrack. The countdown for the equalization time starts as soon as the equalization voltage {10021} is reached and lasts as long as the battery voltage is higher than the absorption voltage {10009}.

In this case, it would be appropriate to set an equalization charging current {10020} to a value different (lower) from the bulk current.

 **Caution:** the equalization of open liquid electrolyte batteries (vented) produces highly explosive gas. The battery room and/or compartment must be adequately ventilated. Be careful: this charging phase may bring the batteries to voltage levels that can damage a sensitive load connected to the battery. Check that the connected loads are compatible with the highest voltage levels possible **taking into account any compensation of the temperature sensor**. A too long or frequent equalization phase can lead to an excessive consumption of electrolyte, a premature ageing or destruction of the battery. Follow scrupulously the instructions and recommendations of your battery supplier.

 **Caution:** incorrect values which do not comply with the manufacturer's instructions can lead to a premature ageing and even the destruction of the batteries.

For more information, contact your battery supplier who will inform you on the values to be applied for his products.

7.2.5 Temperature compensation

If a BTS-01 or BSP temperature sensor is used, the voltage adjustment thresholds for charging the battery (absorption, equalization, floating...) are automatically corrected in real time according to the battery temperature.

The value of this compensation in mV/°C/cell for a reference temperature of 25°C is set by parameter {10036} to -3mV/°C/cell. For example: for a 24V battery (12 cells of 2V) at a temperature of 30°C, the voltage compensation is: $(30-25)*12*(-3/1000) = -0.18V$

For a floating voltage value {10005} set to 27.2V, the effective floating voltage (compensated) will be 27.02V.

 Before opening the VarioTrack, it is absolutely mandatory to disconnect all DC sources (battery and PV) from the equipment to avoid any danger. Before opening the equipment, let the internal filtering capacitors to discharge.

7.3 DEFAULT BATTERY CHARGE CYCLE (ORIGINAL SETTINGS)

The charge cycle set by default does not allow the equalization phase and carries out only phase 1 (bulk), 2 (absorption) and 4 (floating) as per the figure to the right.

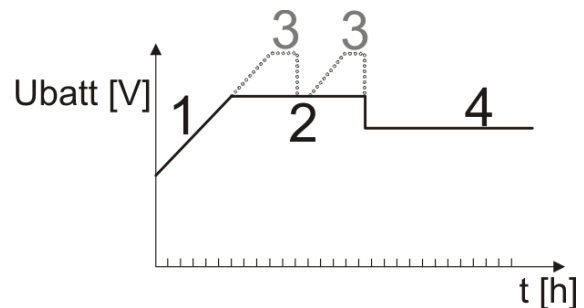

These factory parameter values of the VarioTrack are adapted to open lead-acid batteries, with no equalization, with an absorption voltage of 14,4/28,8/57,6V for 2h and a floating voltage of 13,6/27,2/54.4V (equivalent to the "off" position of the DIP switches n° 2, 3 and 4 when the VarioTrack is configured using the internal DIP switch bank).

8 CONFIGURING THE VARIOTRACK(S)

The VarioTrack can be configured simply, allowing charge behaviours that meet perfectly the requirements of most lead-acid batteries. This configuration can be carried out using the DIP switches (9) inside of the equipment to set the various configurations according to the position of each DIP switch.

	If an Xtender inverter/charger is interconnected (communication) to a VarioTrack, the Xtender battery cycle will be imposed to the VarioTrack of the system. This function may be disabled by parameter {10037}. If no Xtender is connected to the VarioTrack, the latter uses its own setting. In the case of an installation with several VarioTracks, the battery cycle is also automatically synchronized.
---	--

It is also possible to make configurations specific to particular requirements of the system thanks to the remote control RCC-02/03 described in the following chapter.

8.1 CONFIGURING THE EQUIPMENT BY MEANS OF THE INTERNAL DIP SWITCHES

DIP switch 1 (first on the left) allows activating the settings defined by the DIP switch bank. This activation will not be taken into account if the parameter {10054} does not allow it. When the settings defined by the DIP switch bank are not activated, the default parameters (see list p. 47) are applied. These parameters can be modified by means of the remote control RCC-02/-03.

	If the default parameters (factory settings) are modified, the new values must be reported in the parameter table p. 47 at the end of the manual which must remain on the installation site at the disposal of the maintenance personnel.
---	---

When the VarioTrack is connected to other VarioTrack units via the communication bus, the settings of the DIP switches must be the same for all the interconnected VarioTrack units. The charge cycle is automatically synchronized and will be equivalent on all units.

When the VarioTrack is connected to Xtender inverter(s), the battery cycle is automatically synchronized with the cycle and the values chosen by the Xtender. This synchronization is disabled by parameter {10037}.

Pos. no. 1	Function
OFF	DIP switches not taken into account. Default parameters, or those set by the remote control RCC-02/03 are active.
ON	DIP switches taken into account or synchronized by the Xtender if activated {10037} and allowed {10054}.

DIP switches no. 2, 3 and 4 allow the battery cycle to be modified as per the table below in order to adapt it to the various types of most common lead-acid batteries. The following values are for a 48V system and must be divided by 2 or 4 in the 24V and 12V applications respectively.

Pos. no.			Battery type	Floating voltage	Absorption voltage/period	Equalization (30min)
2	3	4				
OFF	OFF	OFF	Open	54.4V	57.6V / 2h	No
ON	OFF	OFF	Sealed w/short abs.	54.4V	57.6V / 1h	No
OFF	ON	OFF	GEL	55.2V	56.8 / 2h	No
ON	ON	OFF	AGM	53.6V	57.2V / 2h	No
OFF	OFF	ON	Sealed w/o abs.	54.4V	No	No
ON	OFF	ON	Open + equalization	54.4V	57.6V / 2h	63.2 V - 1/ 20 days + manual
OFF	ON	ON	Open + equalization	54.4V	57.6V / 2h	63.2 V + manual
ON	ON	ON	Open - reduced voltage	53.6V	57.2V / 2h	63.2 V - 1/ 20 days + manual

DIP switches **no. 5 and 6** do not have a dedicated functionality (spare).

DIP switches **no. 7 and 8** allow setting the battery voltage.

The automatic mode measures the battery voltage upon connection of the equipment and sets the system rated voltage:

If $V_{batt} < 17V$ → 12V system

If $17V < V_{batt} < 34V$ → 24V system

If $34V < V_{batt}$ → 48V system

Pos.no. 7	Pos. no. 8	Battery voltage
OFF	OFF	Automatic selection
OFF	ON	12V
ON	OFF	24V
ON	ON	48V

This automatic detection is correct in most cases. But the connection of a much discharged battery may lead to an error in the automatic voltage selection. For example, the connection of a highly discharged 24V (16V) battery will select automatically a voltage of 12V which prevents to recharge the battery. This is the reason why it is advisable to set manually the system voltage either using the DIP switches (see table above), either using the RCC remote control.

Settings defined by the position of the DIP switches may be inhibited (disabled) with parameter {10054} using the remote control RCC-02/03. The VarioTrack operation will then be defined only by the parameter values set by default or by the RCC remote control.

i

When several VarioTracks are interconnected (communication) and linked to the same battery, differences in production (power) are normal, especially in the following cases:

- The units are in voltage regulation phase (absorption, equalization, floating), and in this case the current distribution may be very uneven. This situation is normal and has no influence on the system efficiency.
- The equipment is in a bulk phase; in this case the difference is due to the difference in size, orientation, cleanness, shade or any other situation that may influence the production capacity of the solar generator. This situation may require the generator to be checked in order to clear/remedy the possible fault.

8.2 DISPLAYING THE EQUIPMENT STATUS USING THE REMOTE CONTROL RCC-02/-03

8.2.1 Displaying the status of a single unit system

The VarioTrack screen allows displaying six values in real time. Four values (a) can be chosen among many measured and calculated values indicated in the table below and two show the status of the auxiliary contacts (b) (these fields are visible even if an ARM-02 is not present).

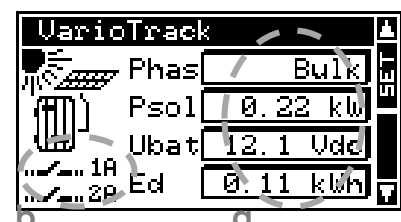

8.2.1.1 Choosing the displayed values

To choose which values to display, press the SET button to enter the first field which will appear in reverse video.

To modify the field content, use the SET button; then by using the arrows, consult the various displayable values and select them as permanently displayable values in the related field by validating with the SET button.

When no other value than the one initially displayed in the field is selected, ESC key validates the initial choice.

The four fields can be scrolled and modified any time to display four of the values indicated in the table below.

Info. no.	Name	Unit	Description
11000	Ubat	Vdc	Battery voltage
11001	Ibat	Adc	Battery current
11002*	Upv	Vdc	Voltage of the PV generator
11004	Psol	kW	Power of the PV generator
11005	Tbat	°C	Battery temperature
11006	Cd	Ah	Production in (Ah) for the current day
11007	Ed	kWh	Production in (kWh) for the current day
11008	kWhR	kWh	Produced energy resettable counter
11010	Cd-1	Ah	Production in (Ah) for the previous day
11011	Ed-1	kWh	Production in (Wh) for the previous day
11015*	Type	Text	Model of VarioTrack (VT-80, VT-65)
11016*	Mode	Text	Operating mode (Night, StartUp, ---, Charger, ---, Security, OFF, --, Charge , Charge V, Charge I, Charge T)
11017*	PVmx	Vdc	Max PV voltage for the current day
11018	Ibmx	Adc	Max battery current of the current day
11019	PVxP	kW	Max power production for the current day
11020	Bmax	Vdc	Max battery voltage for the current day
11021	Bmin	Vdc	Min battery voltage for the current day
11025*	Sd	h	Number of irradiation hours for the current day
11026*	Sd-1	h	Number of irradiation hours for the previous day
11034*	Err	Text	Type of error (No Error, BatoverV, Earth, No Batt, OverTemp, BatOverV, PvOverV, Others, ---, ---, ---, ---)
11037	EqIn	days	Number of days before next equalization
11038	Phas	Text	Battery cycle phase (Bulk, Absorpt., Equalize, Floating, ---, ---, R.float., Per.abs., ---, ---, ---, ---)
11066	Sync	Text	Synchronisation state (---, ---, ---, ---, XTslave, VTslave, ---, ---, VTmaster, Autonom., VSslave, VSmaster)
11069	VS state	Text	State of the VarioTrack (Off, On)

*these values can't be displayed in the multi-unit display. They will be visible while going in the sub-screen of the Multi-unit display, showing every unit individually.

8.2.1.2 Displaying the triggering source of the auxiliary relays

To view the actual triggering source of the two auxiliary relays, press the SET button and use the up/down arrows to navigate down to the two relay fields (b). Select one of the two relays and press SET to view the information indicating the cause of the last relay activation (if the relay is presently activated) or deactivation (if the relay is presently deactivated). The display also shows the logic combination mode: AND or OR.

To exit the selected relay field, press ESC.



These information fields are visible even if the auxiliary relay ARM-02 see chapter 9.3, is not connected.

8.2.2 Displaying the operating mode of the equipment (Info n° 11016)

Night: the solar generator voltage (or luminous intensity) is not enough to start the equipment. When this indication appears during the day, it means a generator fault (wiring).

Start-up: the solar generator (or luminous intensity) is not enough to start the equipment but sufficient to produce power. This indication only appears in the morning or in the evening.

Charger: the charger operates normally at the maximum power point of the solar generator

Charger U: the charger operates in voltage regulation (absorption, equalization or floating). In this status, it is normal to see a current lower than the maximum possible

Charge I: the VarioTrack has reached the maximum allowed current fixed by the parameter {10002} "battery charge current". In this status, the power of the generator is limited to a lower value than the maximum possible.

Charge T: the maximum permissible temperature of the VarioTrack is reached and the power is limited by the temperature. This status is not a problem but may highlight that the system performances could be enhanced by reducing ambient temperature or, if the model is a VT-65, by adding the external cooling fan unit ECF-01 (see chap. 9.4 - p. 42)

Security: the equipment turns off due to a fault normally indicated by a message on the RCC or by the "error" indicator (3) on the equipment.

Off: the equipment is manually turned off by the operator or using a remote control.

8.2.3 Displaying security errors (Info n°11034)

When a security error occurs, the device will stop functioning. A short text, limited to 8 characters, will appear on the display indicating which kind of error it is.

Text	Description
None	No error. The unit is fully functional
GroundFD	A ground fault is detected depending on to the configuration chap. 4.6.1 (Alarm 81)
Ovtemp	An abnormal high temperature is detected (Alarm 014).
OverVba	The battery voltage is over 68V (Alarm 020).
OverVpv	There is a PV voltage over 75V in a 12V system or over 145V in others. (Alarm 82).
NoBatt	No Battery or battery below 7V or reversed battery polarity. (Alarm 80)

8.2.4 Displaying the values of a multi-unit system

When several VarioTrack units are connected to the remote control RCC-02/-03, the screen VarioTrack MULTI appears, displaying the consolidated values for all the connected equipment. The displayed values can be selected as per the same procedure described in chap. 8.2.1.1. Moreover, the units can be viewed one by one by using the arrows up/down after the SET button (2x) when the cursor in reverse video is pointing to the field "MULTI".

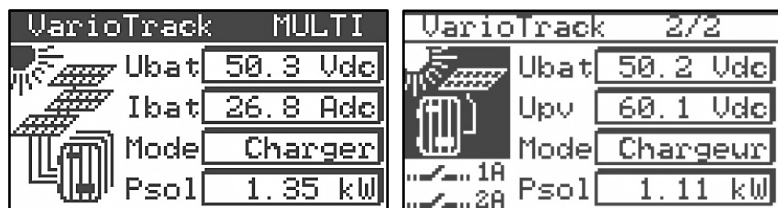

8.2.5 Displaying messages and event history

The message system is the same as for an Xtender inverter and the alarm messages/information are stored and displayed in the "Event history" window. See user manual for the RCC.

8.2.5.1 Message list

Alarm (000): low battery voltage: the battery voltage is lower than 1.66V/element. The VarioTrack continues to operate.

Message (012): management of the BTS (temperature sensor): this indication is given only if the sensor is connected to the VarioTrack when it is energized.

Switch off (014): EL Over-temperature: the warmest point inside the equipment has exceeded 85°C. The equipment stops operating. It starts again when the temperature drops back to a normal value.

Error (016): cooling error: this indication is given only if the equipment is operating when the external cooling unit has been removed or when the connection has been interrupted for an unspecified cause.

Switch off (020): battery overvoltage: the battery voltage is higher than 2.83V/element. The VarioTrack turns off. It starts again when the voltage returns to a normal value.

Error (80): no battery (or polarity reversal): the battery voltage is lower than 7 V. This can be due to the absence of the battery, a highly discharged battery or a polarity reversal.

Alarm (81): PV earth fault: the battery earthing does not (anymore) match the selection made by parameter {10060} which establishes the type of earthing to be checked.

Alarm (82): PV overvoltage: the solar generator has a voltage higher than 145V when connected to a 24 or 48V battery.

 Caution: in a 12V system, the max permissible voltage for a PV generator is 80V. When a higher voltage is applied, the VarioTrack switches off and the supply to the accessories connected to the communication bus is interrupted.

Message (83): no solar production for 48h: no PV voltage has been detected for 48H. The PV generator has probably been disconnected. Check the protection devices (fuse or circuit breaker) and/or check the wiring.

Message (84): equalization carried out: indicates the end of the equalization cycle.

8.3 CONFIGURING THE VARIOTRACK USING THE REMOTE CONTROL RCC-02/03

Many parameters are stored in the VarioTrack internal memory. When a parameter is modified using the remote control RCC-02/03 (hereafter referred to as RCC), it is sent to the VarioTrack and stored permanently.

If the RCC is removed from the system, this parameter continues to be used by the VarioTrack with this modified value. If the VarioTrack is de-energized and then energized again, the new value can be retrieved from the memory. This allows for example to pre-program a VarioTrack at the workshop and to supply it to a customer, ready for his specific application.

If the settings made using the DIP switches are disabled, either because the Pos 1=off or because the parameter disabling the DIP switches {10054} = yes, the VarioTrack uses its stored values. The factory parameter values of the equipment are equivalent to the values set when all the DIP switches are in "OFF" position, i.e. adapted to an open battery, without equalization, with an absorption voltage of 214,4/28,8/57,6V during 2h and a floating voltage of 13,6/27,2/54,4V.

The parameter values can be modified using the RCC and are stored and applied by the VarioTrack.

 When parameter {10054} is set to "yes", the DIP switches remain disabled even when the remote control and the communication module are removed after the settings have been entered. This allows to establish the operation of the installation and to prevent any further modification using the DIP switches.

 When the remote control RCC is connected to the VarioTrack by the communication bus it is possible that the software versions are not compatible. It is highly recommended to update the software of all components in the system in order to guarantee all functionalities. Therefore, before starting the setup of the device, download the latest software version from our website: www.studer-innotec.com on an SD card. Follow the instructions in the RCC manual for a successful installation.

8.3.1 The real time clock

The VarioTrack features a real time clock that allows among others to have a correct date and hour for the RCC records. This clock must be set using the remote control RCC-02/-03. Thanks to an internal battery, this setting is retained even when the equipment is disconnected from its voltage source (battery or PV).

8.4 DESCRIPTION OF THE VARIOTRACK PARAMETERS

The parameters of the VarioTrack can be modified in the menu "VarioTrack MPPT settings" of the RCC remote control.

This menu allows accessing the following 3 under-menus:

BASIC SETTINGS: where the most common parameters to be set when commissioning are found.

BATTERY MANAGEMENT AND CYCLE: where all the parameters can be set, defining in detail the battery cycle during all its phases.

SYSTEM MENU: gathering a few parameters that are not directly related to the battery cycle, such as backing up and restoring the system, resetting, monitoring setting, etc.

8.4.1 Convention

Functions and values of the parameters mentioned in this manual are described in this chapter. Each parameter is defined by a short description, a number {xxxxx} followed by its value and unit by default (xxxxx). The type of parameter (menu, signal) replaces the value between brackets when this latter does not exist. The RCC menus are also identified by a name and a number {xxxxx} that can be found, as per the parameter number, on the top right-hand corner of the RCC screen.

8.4.2 Parameter access level

All the parameters described hereafter are accessible through 2 different access levels. In factory configuration, only a few of them are accessible through the "basic menu". To access all the other menus and parameters, the RCC must be configured at the "Expert" level following the procedure given in the RCC manual, chapter "USER LEVEL" (p. 22).

Each parameter can be placed at a different level (for example, from level "Expert" to level "Basic"). In this case, the parameter is accessible also when the RCC is set to basic mode. For more information on this subject, refer to chapter "INSTALLER, LEVEL OF USE AND ACCESSIBILITY" p.39 in the RCC manual.

8.4.3 Organisation of the configuration menu

Level	User ref.	Parameter
Basic	10000	BASIC SETTINGS
Expert	10054	Block manual programming (dip-switch)
Basic	10001	Voltage of the system
Basic	10037	Synchronisation battery cycle with Xtender
Basic	10005	Floating voltage
Basic	10009	Absorption voltage
Basic	10017	Equalization allowed
Basic	10021	Equalization voltage
Basic	10056	Restore default settings
Inst.	10057	Restore factory settings
Expert	10003	BATTERY MANAGEMENT AND CYCLE
Basic	10037	Synchronisation battery cycle with Xtender
Expert	10002	Battery charge current
Expert	10036	Temperature compensation
Expert	10004	Floating phase
Basic	10005	Floating voltage
Expert	10006	Force phase of floating
Expert	10007	Absorption phase

Level	User ref.	Parameter
Expert	10008	Absorption phase allowed
Basic	10009	Absorption voltage
Expert	10010	Force absorption phase
Expert	10011	Absorption duration
Expert	10012	End of absorption triggered by the current
Expert	10013	Current threshold to end absorption phase
Expert	10016	Equalization phase
Basic	10017	Equalization allowed
Expert	10018	Force equalization
Basic	10021	Equalization voltage
Expert	10020	Equalization current
Expert	10022	Equalization duration
Expert	10052	Equalization with fixed interval
Expert	10025	Days between equalizations
Expert	10026	End of equalization triggered by the current
Expert	10027	Current threshold to end equalization phase
Expert	10019	Equalization before absorption phase
Expert	10028	New cycle
Expert	10029	Force a new cycle
Expert	10030	Voltage level 1 to start a new cycle
Expert	10031	Time period under voltage level 1 to start a new cycle
Expert	10032	Voltage level 2 to start a new cycle
Expert	10033	Time period under voltage level 2 to start a new cycle
Expert	10034	Cycling restricted
Expert	10035	Minimal delay between cycles
Expert	10038	SYSTEM
Expert	10054	Block manual programming (dip-switch)
Expert	10060	Check Earthing
Inst.	10087	Disabling of the display button
Expert	10200	Reset PV energy meter
Expert	10043	Reset solar production counters
Expert	10044	Reset daily min-max
Basic	10056	Restore default settings
Inst.	10057	Restore factory settings
Inst.	10058	Parameters saved in flash memory
Expert	10039	ON of the VarioTrack
Expert	10040	OFF of the VarioTrack
Expert	10051	Reset of all VarioTrack

8.4.3.1 Auxiliary relay parameters

A list of the auxiliary relay parameters can be found at the end of this manual on page 48.

8.4.4 Basic menu {10000} (menu)

8.4.4.1 System voltage {10001} (Automatic)

The VarioTrack can recognize the battery automatically. When powered up (battery side), it measures the existing voltage and detects whether it is a 12V, 24V or 48V battery.

The VarioTrack can be forced to operate with a certain voltage thanks to parameter {10001}. When the battery voltage is clearly known, it might be useful to set the battery voltage (12V, 24V or 48V). This may avoid a possible confusion when connecting an extremely discharged battery and may allow recovering such a battery.

8.4.4.2 Synchronization of a battery cycle with an Xtender {10037} (yes)

When a Studer inverter of the range Xtender is used in the system, it can transfer to the VarioTrack its battery charge setting so that they can operate together in an optimum way.

Synchronization allows a coherent operation of multiple units which participate to the battery charging and avoids multiple successive equalizations triggered by each charger.

8.4.4.3 Battery floating voltage {10005} (13.6V/27.2V/54.4V)

Determines the voltage applied when the battery is fully charged. This voltage prevents self-discharge and keeps the battery to its optimum charge level.

8.4.4.4 Absorption voltage {10009} (14.4V/28.8V/57.6V)

Determines the battery voltage during the absorption phase. See chap. 7.2

8.4.4.5 Equalization authorized {10017} (no)

Determines whether the equalization phase (triggered manually or automatically) is allowed or not.

8.4.4.6 Equalization voltage {10021} (15.6V/31.2V/62.4V)

Determines the battery voltage during the equalization phase.

8.4.4.7 Restoring the default parameters {10056} (signal)

Sending this signal restores the original values of the VarioTrack parameters.

	If the installer has made some adjustments during the commissioning of the installation, this function does not restore the factory settings but those made by the installer.
---	---

8.4.5 Management and battery cycle {10003} (menu)

The VarioTrack battery charger is designed to ensure a battery charge as complete as possible. The charge process, described in detail in chapter 7.2, is managed in 4 successive phases of which only 3 are activated by default. Thus the VarioTrack will carry out only phases 1 (bulk), 2 (absorption) and 4 (floating) according to a charge profile as per the figure to the right which represents the basic cycle. This basic cycle takes place automatically.

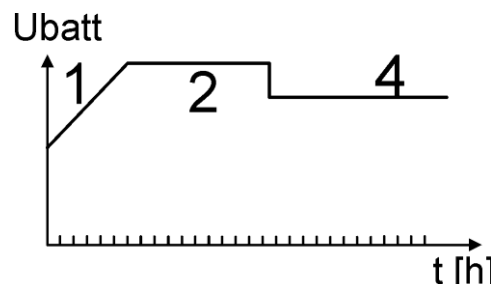

The charge curve obtained this way depends on a whole series of parameters that may be freely modified in order to get a charge profile that meets at best the requirements set by the manufacturer or the user.

If the BTS-01 temperature sensor is used, the voltage regulation thresholds of the battery are corrected in real time according to the battery temperature. The value of this compensation in mV/°C/cell for a reference temperature of 25°C is set by parameter {10036} to -3mV/°C/cell. For example, at 30°C for a 24V battery having thus 12 cells of 2V: $(30-25) \cdot 12 \cdot (-3/1000) = -0.18V$, a floating set to 27.2V is compensated to a value of 27.02V.

	The battery setting is carried out under the responsibility of the operator. An incorrect setting that does not meet the battery charging methods recommended by the manufacturer may be dangerous and/or considerably reduce the battery service life. If the factory settings are modified, the new values must be entered in the parameter table at the end of this manual.
---	--

8.4.5.1 Synchronization of a battery cycle with an Xtender {10037} (yes)

This parameter appears on the basic menu and is described in chapter 8.4.4.2.

	When this parameter {10037} is activated, all other parameters involved in the battery cycle are hidden and not accessible. In this case, only the maximum charging current is adjustable.
---	--



If an Xtender inverter/charger is interconnected (communication) to one/several VarioTrack, the Xtender battery cycle will be imposed to the VarioTrack of the system. This function may be disabled by parameter {10037}. If no Xtender is connected to the VarioTrack, the latter uses its own setting.

8.4.6 Floating phase {10004} (menu)

8.4.6.1 Floating voltage {10005} (13,6V/27,2V/54,4V)

Determines the voltage applied when the battery is fully charged. This voltage prevents self-discharge and keeps the battery to its optimum charge level.

8.4.6.2 Force floating phase {10006} (signal)

This parameter may be used to force a battery cycle in progress to assume the final values of the floating voltage phase. If the battery voltage level is higher, the charger momentarily switches out until the new target voltage is reached.

8.4.7 Absorption phase {10007} (menu)

During this phase, the battery accumulates the last percentages of power to be stored. This phase takes place at a constant voltage. Over the course of this phase, the necessary current diminishes progressively. Therefore, the VarioTrack does not work at the optimal point of the PV generator because all the available PV power is not required.

8.4.7.1 Absorption phase allowed {10008} (yes)

This parameter determines whether the absorption phase is carried out or not. When this phase is disabled, the charger goes directly to the following authorized phase (equalization, but most often a floating phase).

8.4.7.2 Absorption voltage {10009} (14.4V/28.8V/57.6V)

Defines the applied voltage during absorption phase.

8.4.7.3 Force absorption phase {10010} (signal)

This signal starts again an absorption phase from the floating phase.

The charge indicator (2) flashes 2x indicating that the equalization phase is on-going.

8.4.7.4 Absorption duration {10011} (120min)

Use this parameter to set the absorption duration. The absorption phase starts once the set tension {10009} is reached. When the time is over (see chap. 7.2.2), the charger goes automatically to the following authorized phase.

8.4.7.5 End of the absorption triggered by the current {10012} (no)

The absorption phase can be interrupted when the battery charging current goes under a certain threshold, at which point the charger automatically passes to the next authorized phase. This can be used in order to shorten the period under which a high voltage is applied and thus reduce water consumption.

8.4.7.6 Current threshold to end absorption phase {10013} (10A)

Sets the current under which the absorption phase is considered finished. When the charger current goes below this value, the next phase (most often the floating phase) starts. If the production of the PV generator is insufficient to keep the voltage, this current is not taken into account and the absorption phase goes on.



Progressively, during the absorption phase, the charging current decreases naturally. If the bulk phase has been carried out with a current appropriate for the battery, it is not necessary to wait for a certain period to finish charging. The absorption phase can be interrupted if the battery charge current falls below a certain level.

8.4.8 Equalization phase {10016} (menu)

Some types of battery need equalization in order to avoid the stratification of the water and acid they contain. Use the parameters hereafter to set the operating conditions of this charging phase as described in chap. 7.2.4.



During an equalization phase, an emission of a highly explosive gas occurs (hydrogen/oxygen). Follow carefully all the instructions of the battery manufacturer regarding this phase. In any case, make sure that the battery room is adequately ventilated. Equalization reduces the battery water level: check it regularly.

8.4.8.1 Equalization authorized {10017} (no)

Determines whether the equalization phase (triggered manually or automatically) is allowed or not.

8.4.8.2 Forcing an equalization {10018} (signal)

Use this parameter to start manually the equalization phase. It is possible to force an equalization phase only when it is authorized by {10017}.



Once equalization phase is initiated, disabling the phase does not stop the equalization. To stop the equalization, force the transition into floating {10006}, absorption {10010} or a new cycle {10029}. It is also possible to interrupt the equalization by pressing the "SET" button for more than 2 seconds (procedure described in chap. 6.1).

8.4.8.3 Battery equalization voltage {10021} (2.6V/element) (15.6V/31.2V/62.4V)

This parameter determines the maximum voltage during the equalization phase.



This voltage is corrected by the temperature compensation factor {10036} if a temperature sensor (BTS-01 or BSP) is installed in the system.

8.4.8.4 Battery equalization current {10020} (80A)

The equalization phase can be carried out with a limited current that can be adjusted using this parameter. In any case, the current does not exceed the bulk current {10002}. As a rule, the limited charging current is used only if the equalization is started at the end of the absorption phase.

8.4.8.5 Equalization period {10022} (30min)

This parameter determines the equalization period. The equalization phase starts as soon as the set voltage {10021} is reached. When the period has elapsed, the charger goes automatically to the following authorized phase. If the voltage cannot be kept (no sunshine, clouds...), the countdown is paused.

8.4.8.6 Equalization at a fixed interval {10024} (yes)

When this parameter is activated (yes), the battery charge cycle with an active equalization phase starts at the interval specified by the following parameter {10025}.

8.4.8.7 Days between the equalizations {10025} (26 days)

This parameter determines the number of days in between the equalizations. This counter is reset to zero when the equalization is activated manually.



In the case of incomplete charging cycles (for example when charging with solar generators), this function is useful also to limit the repetition of the equalization cycles. When the number of days is reached, a new cycle is not initiated automatically. The equalization will take place during the following charge cycle.

8.4.8.8 End of the equalization triggered by the current {10026} (no)

Progressively, during the equalization phase, the charging current decreases naturally. If the bulk phase has been carried out with a current appropriate for the battery, it is not necessary to wait for a certain period to finish charging. The equalization phase can be interrupted when the battery charging current goes under a certain threshold. This can be used in order to reduce the equalization duration and the electrolysis phenomenon related to it.

8.4.8.9 Final current of the equalization phase {10027} (no)

This parameter determines at which current the equalization phase is considered finished. The next phase starts, when the charger current goes below this value.

8.4.8.10 Equalization before absorption phase {10019} (yes)

This parameter determines if during the charge cycle the equalization will take place before or after the absorption phase. By default, the equalization phase is carried out before the absorption phase.

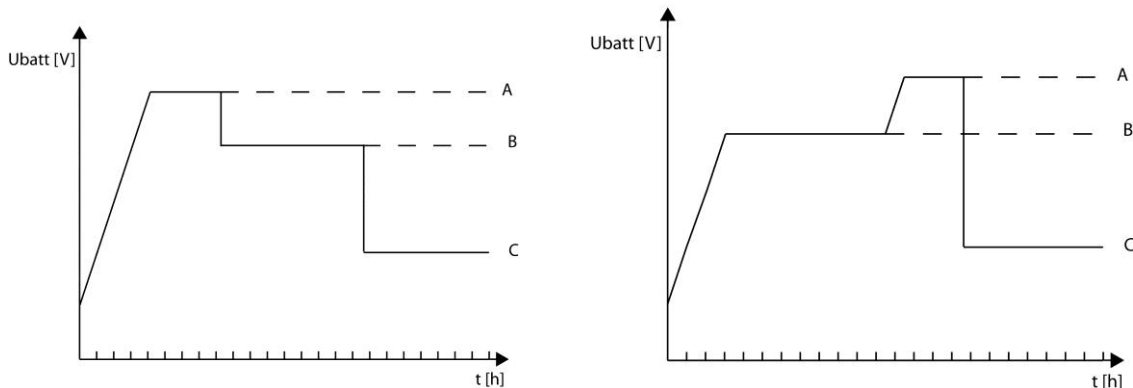

A= equalization voltage, B= absorption voltage, C= floating voltage

8.4.9 New cycle {10028} (Menu)

Usually, batteries are charged during the day via the PV generator then partially discharged during the night by the user. The next day, a charge cycle starts again (bulk-absorption-floating). The conditions to restart a full cycle are met when the battery has lost some of its power because of the users who are connected to it. These conditions are set by parameters from {10030} to {10033}. If these conditions have not been met because, for example, the installation has no users, a new absorption phase will not be necessary as this would lead to slight battery water consumption. In this case, the charge cycle is kept in floating phase.

8.4.9.1 Forcing a new cycle {10029} (signal)

This parameter enables to force manually a complete charge cycle. The VarioTrack switches immediately to the bulk phase.

8.4.9.2 Conditions for a new cycle

A new battery cycle will be triggered if one or the other 2 conditions -defined by a period of time during which the battery voltage is lower than a threshold- is met. These 2 voltages related to 2 durations are configurable. Usually a higher voltage is used for a longer duration and a lower voltage for a shorter duration.

Voltage 1 for a new cycle {10030} (12.2V/24.4V/48.8V)
Duration under voltage 1 for a new cycle {10033} (30min.)
Voltage 2 for a new cycle {10032}(11.8V/23.6V/47.2V)
Duration under voltage 2 for a new cycle {10033} (2min.)

8.4.9.3 Maximum limit of the cycle repetition {10034} (Yes)

The repetition of the charge cycles can be limited establishing the minimum time between each cycle using parameter {10035}.

8.4.9.4 Minimum interval between cycles {10035} (1h)

Determines the minimum interval (time) between each cycle when parameter {10034} activates this function.

	<p>If the parameter {10034} is activated and the interval parameter {10035} is set to 24h, there will be only one charge cycle per day. In this case, if the conditions are met for a new cycle, it will not take place until the next day and the charger will keep the battery at floating voltage.</p>
---	---

8.4.9.5 Correction coefficient for battery temperature {10045} (-3mV/°C/cell)

If a battery temperature sensor (BTS-01) is used in the system, the charging voltages are automatically adapted to the battery temperature. The compensation is given in millivolts per degree Celsius (°C)

and per battery cell. For example, at 30°C for a 24V battery having thus 12 cells of 2V: $(30-25) \cdot 12 \cdot (-3/1000) = -0.18V$, a floating set to 27.2V is compensated to a value of 27.02V.

8.4.9.6 Battery charging current {10002} (80A)*

The VarioTrack tries to maximize the battery charging current up to its rated current; however, it is possible to limit this current using this parameter for small capacity batteries. The current appropriate to the battery is reported in its technical data. The value set by this parameter is used during the bulk phase.

*Note: On the VT-65 model, the displayed (factory) value remains 80 A but the maximum effective value will be 65A.

	<p>If no information to determine the charging current is available, the most frequently used value is of one fifth of the battery capacity. Ex. for 500Ah: $500/5 = 100A$. Caution: if your batteries are in series, to calculate the capacity, only one has to be taken into account and not the sum. If the battery bank is composed of several strings, to calculate the capacity, the sum of the capacities of a battery of each string has to be taken into account.</p>
---	--

8.4.10 System {10038} (menu)

8.4.10.1 Prevents the configuration made by DIP switches {10054} (no)

Blocks the operating mode chosen by means of the DIP switches inside the VarioTrack.

	<p>If Parameter {10054} is set on "yes", the DIP switches will remain disabled even if the RCC is removed after configuration. This secures the configuration of the facility and to prohibit any subsequent changes with the DIP Switches.</p>
--	---

8.4.10.2 Checking the earthing {10060} (no control)

When the battery negative pole is earthed as per recommendations in chap. 4.6, this connection can be checked by the VarioTrack continuously. Should this connection be faulty, the equipment turns off immediately and a fault is displayed (see chap. 6.4) or notified by an alarm message on the RCC (see chap. 8.4.4.1). The various earth connection types that can be checked are the following:

- No check (default value)
- The negative pole of the battery is earthed
- The positive pole of the battery is earthed
- Floating battery (with no earthed poles) (In a system with 12V battery, the floating battery control should not be activated.)

8.4.10.3 Reset PV energy meter {10200}

This parameter allows you to reset the PV energy meter to zero. This could be useful if you wish to measure the energy produced over a given time interval.

8.4.10.4 Reset les compteurs de production solaire journaliers {10043} et

8.4.10.5 Reset les min-max journaliers {10044}

These parameters allow you to reset to zero the different corresponding daily meters. This could be useful if you wish to know these values precisely over a specific period of time.

8.4.10.6 Restore default settings {10056} (signal)

This signal will restore the initial parameters of the VarioTrack.

	<p>If the installer made specific setting at commissioning, this function will restore these settings instead of the factory settings.</p>
---	--

8.4.11 Auxiliary contacts 1 {10088} and 2 {10142} (menu)

When connected to the ARM-02 module (see chap. 9.3 – p. 42), the solar charge controller VarioTrack has two additional external auxiliary relays with potential-free dry reversing contacts. These two relays make it possible to realize multiple functions with appropriate cabling and simple programming.

The programming of each contact is made independently apart from when a function requires two relays. In this case the programmed events for activating the second relay are automatically deactivated. The auxiliary contacts are activated and deactivated with a 2 second delay to avoid too frequent switching.

The auxiliary contacts react to different types of signals, graphically illustrated below. Basic events that activate the contacts are:

- Simple events
- Scheduled events
- Levels

In the following descriptions, each parameter has two reference numbers. The reference number on the left refers to the auxiliary contact 1 and the reference number on the right refers to the auxiliary contact 2. ({reference auxiliary contact 1} {reference auxiliary contact 2}).

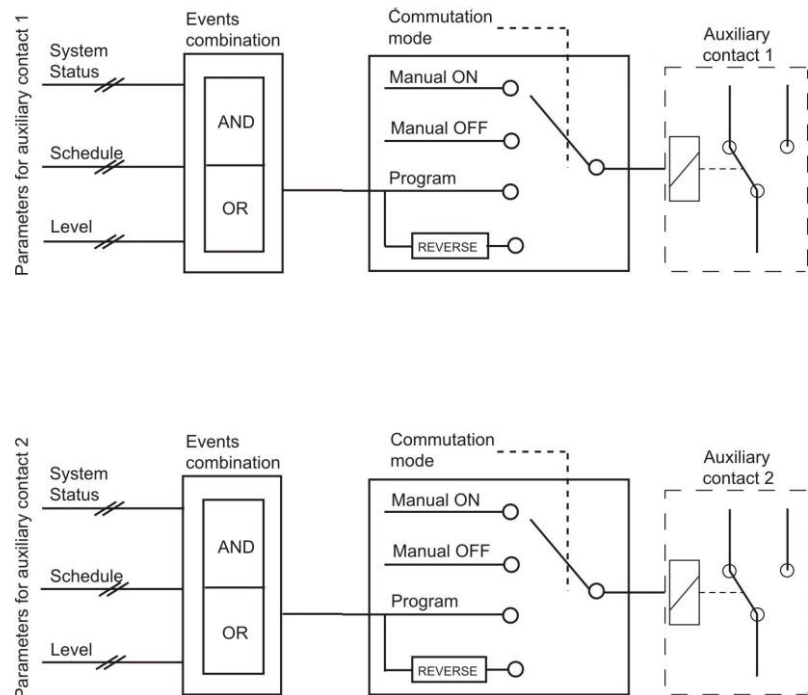

8.4.12 Simple functions

8.4.12.1 Switching mode {10089} {10143} (Automatic)

The auxiliary contact can be controlled in 4 different ways:

Manual ON: in this mode, the contact is permanently activated "ON" whatever the external conditions or programming.

	Use this function before programming a new function for an auxiliary contact in order to be certain that no other function will activate the contact unintentionally.
--	---

Manual OFF: in this mode, the contact is permanently deactivated "OFF" whatever the external conditions or programming.

Automatic: in this mode the auxiliary contact is activated according to the conditions and restrictions of its programming.

Reversed automatic: in this mode, the conditions and restrictions define the deactivation of the relay.

1.1.1.1 Reset of the programming {10141} {10195} (signal)

This function erases the programming of the indicated auxiliary contact. Once completed the auxiliary contact is completely deactivated. Be aware that this action cannot be undone.

8.4.12.2 Combination of events mode {10090} {10144} (OR)

This parameter defines how various events intended to activate the auxiliary contact are combined. The contact can be activated either by a single event (OR function) or by all events being fulfilled at the same time (AND function).

8.4.12.3 Contacts activated in night mode {10092} {10146} (menu)

The auxiliary contact can be activated with the function "night mode". When the "night mode" is activated and the activation delay is up, the auxiliary contacts will be active for a predefined time period. If the activation time is set to zero, the auxiliary contact will remain permanently activated until the end of the night mode.

- Activated in night mode {10093} {10147} (non)
- Delay of activation after entering night mode {10094} {10148} (1 min)
- Activation time for the auxiliary relay in night mode {10095} {10149} (1 min)

8.4.12.4 Contacts activated by an event {10096} {10150} (menu)

Different states and events within the installation can be used to activate the auxiliary contacts. The events can be combined with each other to create complex functions.

8.4.12.4.1 VarioTrack ON {10198} {10199} (no)

The contact is activated if the VarioTrack is switched ON.

8.4.12.4.2 VarioTrack OFF {10091} {10145} (no)

The contact is activated if the VarioTrack is switched OFF.

8.4.12.4.3 Battery undervoltage {10097} {10151} (no)

The contact is activated in the event of battery undervoltage.

8.4.12.4.4 Battery overvoltage {10098} {10152} (no)

The contact is activated in the event of battery overvoltage.

8.4.12.4.5 Earth fault {10099} {10153} (no)

The contact is activated in the event of an earth fault.

8.4.12.4.6 PV error (48h without load) {10100} {10154} (no)

The contact is activated in case the battery has not been charged in the last 48 hours.

8.4.12.4.7 Over temperature {10102} {10156} (no)

The contact is activated in the event of over temperature of the device.

8.4.12.4.8 Battery charging in bulk phase (Bulk) {10104} {10158} (no)

The auxiliary contact is activated if the battery is charging in the bulk phase.

8.4.12.4.9 Battery charging in absorption phase {10105} {10159} (no)

The auxiliary contact is activated if the battery is charging in the absorption phase. If the extended periodic absorption function is activated, the contact is also activated in this phase.

8.4.12.4.10 Battery charging in equalization phase {10106} {10160} (no)

The auxiliary contact is activated if the battery is charging in the equalization phase.

8.4.12.4.11 Battery charging in floating phase {10107} {10161} (no)

The auxiliary contact is activated if the battery is charging in the floating phase. If the extended reduced floating function is activated the contact is also activated in this phase.

8.4.12.4.12 Battery charging in reduced floating phase {10108} {10162} (no)

8.4.12.4.13 Battery charging in periodic absorption phase {10109} {10163} (no)

You can activate the auxiliary contacts on the reduced floating phase and periodic absorption phase in presence of an Xtender and synchronised with the battery cycle.

8.4.12.5 Contacts activated by the battery voltage {10110} {10164} (menu)

These parameters activate the auxiliary contacts if the voltage drops below a pre-defined voltage level during a set time period. It is possible to define three voltages linked with three time periods to activate the auxiliary contact. The auxiliary contact will only become deactivated when the battery has risen above a certain voltage and a certain time period, both values independent of the activation parameters. This voltage and time period for deactivation is also programmable.

- Voltage 1 active {10111} {10165} (no)
- Voltage 1 {10112} {10166} (11.7V/23.4V/46.8V)
- Duration 1 {10113} {10167} (1min)

- Voltage 2 active {10114} {10168} (no)
- Voltage 2 {10115} {10169} (11.9V/23.8V/47.6V)
- Duration 2 {10116} {10170} (10min)

- Voltage 3 active {10117} {10171} (no)
- Voltage 3 {10118} {10172} (12.1V/24.2V/48.4V)
- Duration 3 {10119} {10173} (60min)

- Voltage for deactivation of the auxiliary contact {10120} {10174} (13.5V/27V/54V)
- Duration over batter voltage for deactivation {10121} {10175} (60min)
- Deactivation if the battery is in floating phase {10122} {10176} (no)

8.4.12.5.1 Deactivation if the battery is in floating phase {10122} {10176} (no)

If you activate one of the auxiliary contacts according to the battery voltage, you can force deactivation if the battery enters the floating phase. This way the auxiliary contact will be released even if the deactivated voltage is not reached or the deactivation time hasn't passed.

8.4.12.6 Contacts activated according to the battery temperature {10123} {10177} (menu)

You can activate an auxiliary contact according to the battery temperature. This function is available with the battery temperature sensor BTS-01 or with the battery status processor BSP. Two distinct levels allow the contact to switch "ON" and "OFF" at different temperatures.

- Contact activated with the battery temperature {10124} {10178} (no)
- Activation temperature for the auxiliary contact {10125} {10179} (3°C)
- Deactivation temperature for the auxiliary contact {10126} {10180} (5°C)

8.4.12.7 Contacts activated on the battery's state of charge (SOC) {10128} {10182} (only available in the presence of a BSP) (menu)

You can activate the auxiliary contacts according to the state of charge of the battery (SOC). If the SOC falls below the set level, the contact will be activated. A time period can be associated with the SOC level to stipulate that the battery must be below the set level a certain time before the contact is activated. The contact is deactivated when the battery's SOC rise above the pre-set level which can also be associated with a time period. The contact may also be deactivated when the battery reaches the floating phase.

- Contact activated at SOC 1 {10129} {10183} (no)
- Contact activated below SOC 1 {10130} {10184} (50%)
- Duration 1 {10131} {10185} (12h)

- Contact activated at SOC 2 {10132} {10186} (no)
- Contact activated below SOC 2 {10133} {10187} (30%)
- Duration 2 {10134} {10188} (0.25h)



- Contact activated at SOC 3 {10135} {10189} (no)
- Contact activated below SOC 3 {10136} {10190} (90%)
- Duration 3 {10137} {10191} (0.25h)

- Contact deactivated below SOC {10138} {10192} (90%)
- Deactivation time {10139} {10193} (0.25h)
- Deactivation if the battery is in floating phase {10140} {10194} (no)

9 ACCESSORIES

9.1 REMOTE CONTROL AND PROGRAMMING CENTRE RCC-02/-03

This accessory is an important complement to the VarioTrack. It can be connected via one of the two communication connectors "Com. Bus" (7) (see chap. 4.1 "Elements of the cable compartment") thanks to the cable supplied with the remote control.

	<p>When the remote control RCC-02/-03 is connected to another compatible device (Xtender, VarioString, BSP, Xcom or other) with the same communication bus it is possible that the software versions are not compatible. It is highly recommended to make a software update of all components in the system in order to guarantee all functionalities. Therefore, before starting the setup of the device, download the latest software version from our website: www.studer-innotec.com on an SD card. Follow the instructions in the RCC manual for a successful installation.</p>
	<p>These connectors must be used only to connect a compatible Xtender accessory, <u>excluding any other type of connection such as LAN, Ethernet, ISDN, etc.</u></p>

The remote control RCC-02/-03 is compatible with the following equipment:

- **VarioTrack** solar charge controller MPPT
- **VarioString** solar charge controller MPPT
- **Xtender** inverters/chargers

When it is connected to at least one of these two devices, it also allows interacting with the other peripherals of an Xtender system, i.e.:

- Battery Status Processor: **BSP-500/BSP 1200**
- RS 232 communication interface: **Xcom-232i**
- Internet based communication sets: **Xcom-LAN, Xcom-GSM.**

It allows the following functionalities for all the connected and compatible equipment:

- Setting the various operating parameters for the connected equipment.
- Displaying the operating synoptic for each part of the equipment.
- Displaying several operating quantities measured or calculated (Current/Voltage/Power, etc.) for each apparatus.
- Updating the software or implementing tailored software.
- Backing up/restoring system parameters (configuration).
- Loading a parameter file (configuration).
- Storing error message history for each device.
- Recording VarioTrack(s) data and other information essential for the system (see chapter "Data recorder" p. 23 in the RCC manual).

RCC-02



RCC-03



Functionalities of the RCC-02 and RCC-03 units are equivalent. They differ only in their external aspect. The RCC-02 is designed for wall mounting whereas the RCC-03 is designed for board mounting.

Model RCC-03 must be removed from the board to access the SD card slot (during updating, for example).

Ref. no./dimensions H x L x l [mm]:

RCC-02 / 170 x 168 x 43.5mm

RCC-03 / 130 x 120 x 42.2mm

i Both remote control models are supplied with a 2m cable.
Cables of specific lengths (5m, 20m and 50m) can be ordered.
Item reference: CAB-RJ45-8-xx. The length in metres is specified by xx.

2 (or max 3 within the same system) remote controls RCC-02/-03 or Xcom-232 can be connected in series to the communication bus of a same VarioTrack.

In a system composed of a single VarioTrack, the connection of the RCC-02 or RCC-03 may be done without stopping the equipment (hot plug). When connecting an RCC-02/-03 remote control in a multi-unit system, all the units in the system must be turned off and the termination of the communication bus where the connection is being made must be modified.

! The termination switch of the communication bus "Com. Bus" (8) remains in position T (terminated) except when both connectors (7) are used. In this case and only in this case, the switch must be placed in the O (open) position (towards element (9)). If only one of the two connectors is used, the termination switch (8) will be in position T.

9.2 TEMPERATURE SENSOR BTS-01

The operating voltages for lead batteries vary depending on the temperature. A temperature sensor is optionally available to correct the battery voltage and guarantee an optimum charge for whatever battery temperature. The correction factor given by the temperature sensor is set by parameter {10036}.

Reference no. for the temperature sensor (including a 5m cable): BTS-01.

Dimensions: H x L x l / / 58 x 51.5 x 22mm.



9.2.1 Connecting the temperature sensor (BTS-01)

The optional temperature sensor BTS-01 is supplied with a 3m cable fitted with RJ11/6-type plugs. It may be connected or disconnected at any time (even when the device is operating) using the corresponding socket (6) marked "Temp. Sens." on the VarioTrack. Plug the connector into the socket (6) until it clicks in. The temperature sensor case may simply be stuck onto the battery or directly next to it. The temperature sensor is automatically recognised and the correction of the voltage thresholds applied immediately. If a BSP battery probe next to the battery is used, a BTS-01 is not necessary. The BSP module is fitted with a temperature sensor. If both elements (BTS-01 and BSP) are present, only the BTS-01 is taken into account to correct the battery temperature.

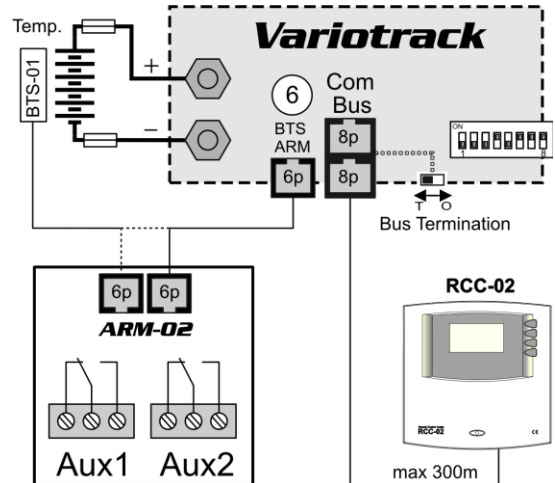

9.3 AUXILIARY RELAY MODULE ARM-02

By connecting the external auxiliary relay module to the VarioTrack, plug (6) provides the solar charge controller with 2 additional relays. If the plug (6) is already occupied by the BTS temperature sensor, you have to unplug it to connect the ARM and thereafter plug the BTS in the free slot of the ARM.

Each auxiliary relay has change-over contacts with programmable activation. The maximal authorized currents and voltages for these contacts are 16A for 230VAC/24Vdc and 3A for 50Vdc. When a contact is activated, the corresponding LED lights up.

There is no dedicated function assigned to these relay. To assign/program functions to these auxiliary contacts, use the remote control RCC-02/03. A description of the necessary parameters is listed in the programming section chap. 0 of this user manual.

The module is to be mounted on a DIN rail and is delivered with a 5 metre connection cable.





Cable-glands that are not in use must be properly closed. If this instruction is not respected, the equipment loses its degree of protection (IP54) and dust or small animals may enter the equipment causing significant damage which is not covered by the warranty.

9.4 EXTERNAL COOLING FAN ECF-01

The cooling fan ECF-01 is an accessory that can be added to model VT-65; this will give it the features of model VT-80 (see technical data p.48). This accessory is automatically detected and the limit of the charging current is 80A when installed.

This fan has a degree of protection IP54 and can be exposed to water spray without damage. However, do not expose it to dirty water splashes in order to prevent mud or similar particles from blocking the mechanism.

The assembly instructions are supplied with the accessory.

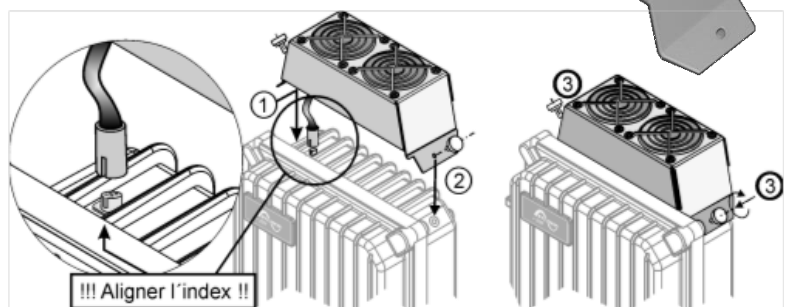
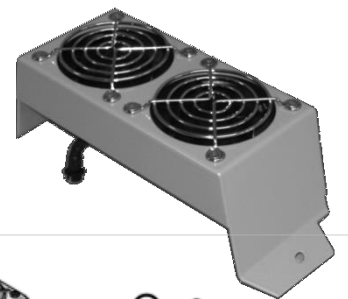

10 EQUIPMENTS COMPATIBLE WITH THE VARIOTRACKS

When making hybrid energy systems, VarioTrack units are often combined with Xtender inverter/chargers mentioned hereunder. They then belong to a system where they are interconnected via the communication bus. The full description of this equipment is available on our website: www.studer-innotec.com

10.1 XTENDER INVERTERS/CHARGERS

The VarioTrack is compatible with the entire Xtender range and it allows making PV/generator or PV/network hybrid systems that are perfectly coherent. The communication between the Xtender(s) and the VarioTrack(s) allow synchronizing the charging cycles of both systems. When the function is activated using parameter {10037}, the Xtender is the master of the charge profile and will impose the voltage limits set by its cycle. It will remain so even if the equipment (Xtender) is turned off using the ON/OFF button or the charger mode is prohibited.

On the other hand, if the Xtender is turned off using the main ON/OFF button (de-energized), the VarioTrack operates with the programmed values.



The charging current of the equipment add up with no priority. When the Xtender charging current is for example set to 100A and the VarioTrack supplies 80A, the battery charging current may be 180A during the bulk phase.

10.2 BATTERY STATUS PROCESSOR BSP- 500/1200

This module, supplied with a 500 or 1200A shunt, allows measuring the current, voltage and temperature of the battery. It calculates and supplies the system with all the information obtained from these measurements such as the state of charge, time before discharge, history of the state of charge over 5 days, etc.



10.3 COMMUNICATION MODULE XCOM-232I

This isolated RS232 module allows accessing most of the values and parameters of the equipment connected to the communication bus. It also features an SD card for the acquisition of measured data, settings and history of the event generated by the equipment.



10.4 COMMUNICATION SETS XCOM-LAN/-GSM

These two sets provide the possibility to control the Xtender, VarioTrack and VarioString systems via the Xcom web portal anywhere there is internet access, via the local network or via the GSM network. The access to internet can be done with a smartphone, tablette or notebook computer.



11 WIRING EXAMPLES

11.1 VARIOTRACK + RCC-02

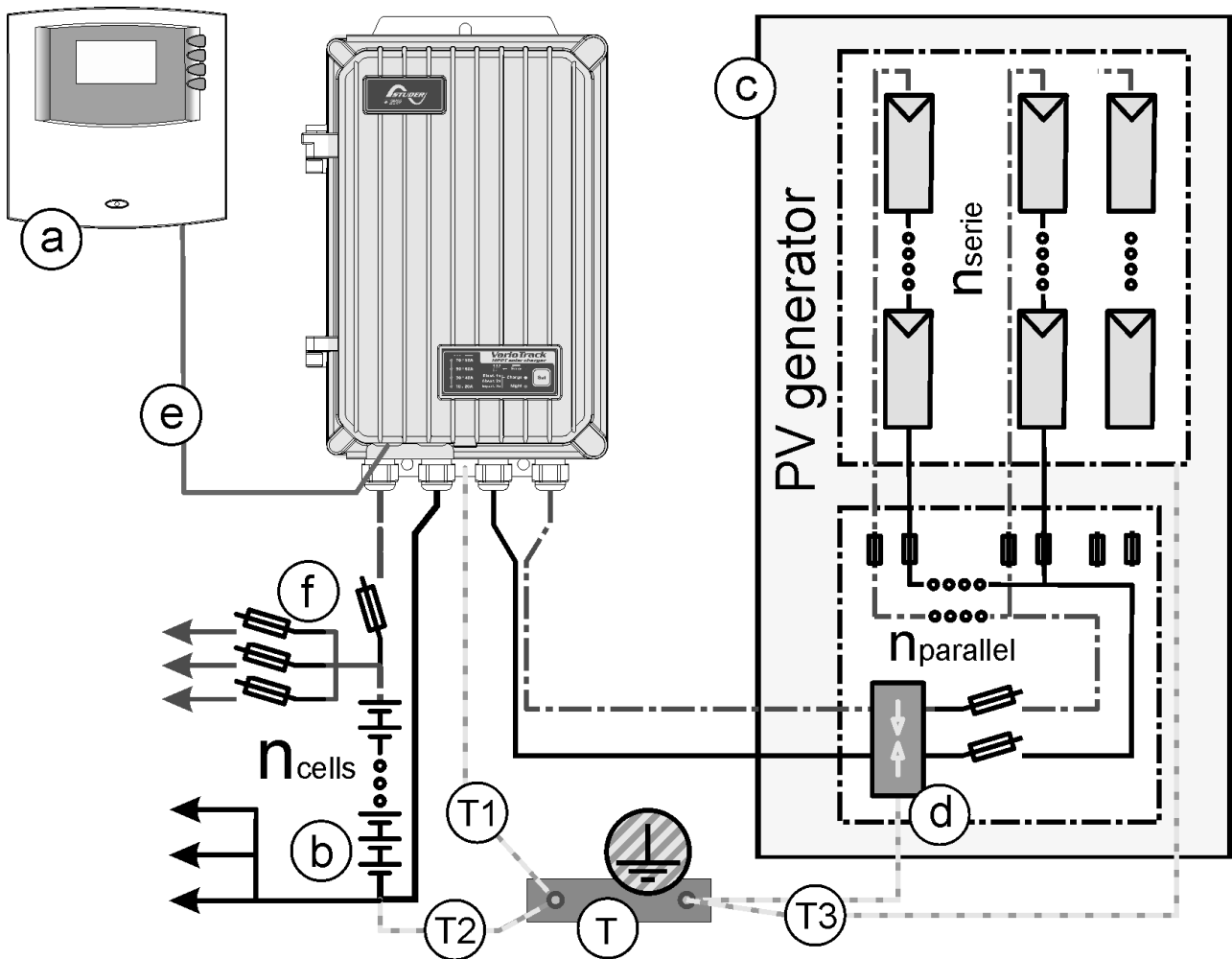

11.2 COMMENTS ON THE WIRING EXAMPLES

Elem.	Description	Refer to
a	Remote control	See chap. 9.1, 8.2 and 8.4.11
b	Battery	See chap. 4.4
c	Photovoltaic generator	See chap. 4.3
d	Lightning protection device	See chap. 4.7
e	Communication cable	See chap. 4.8
f	DC protection device	See chap. 4.4.4
k	Inverter Charger	See chap. 10.1
s	Battery Temperature sensor BTS-01	See chap. 9.2
T	Protective earth	*Main protective earth/protective equipotential bonding connected to the conductive and accessible parts of the building and if possible, connected to a standard earth electrode.
T1	Protective earth for the equipment	*The equipment is designed to be connected to a protective earth (Class I) to which they must be connected.
T2	Protective earth for the battery	*The battery negative pole must be earthed. The other configurations must meet the recommendations at chap. 4.6

T3	Protective earth for the solar generator	*The protective earth for the PV generator and its lightning protection device are connected separately to the main protective earth (local equipotential bonding).
T4	Protective earth for the generator or the AC source	*Most often, within a hybrid installation, it is recommended to connect the earthing of the whole frame and the earthing of the lightning protection device to the main protective earth (T).
U	AC wiring related to the Xtender, not described in this manual	See chap. 10.1
V	Wiring related to the BSP, not described in this manual	See chap. 10.2

* National installation standards specific to the chosen application field must absolutely and as a priority be respected under the installer's responsibility.

11.3 VARIOTRACK + XTENDER + RCC-02 + BSP + BTS-01 HYBRID SYSTEM

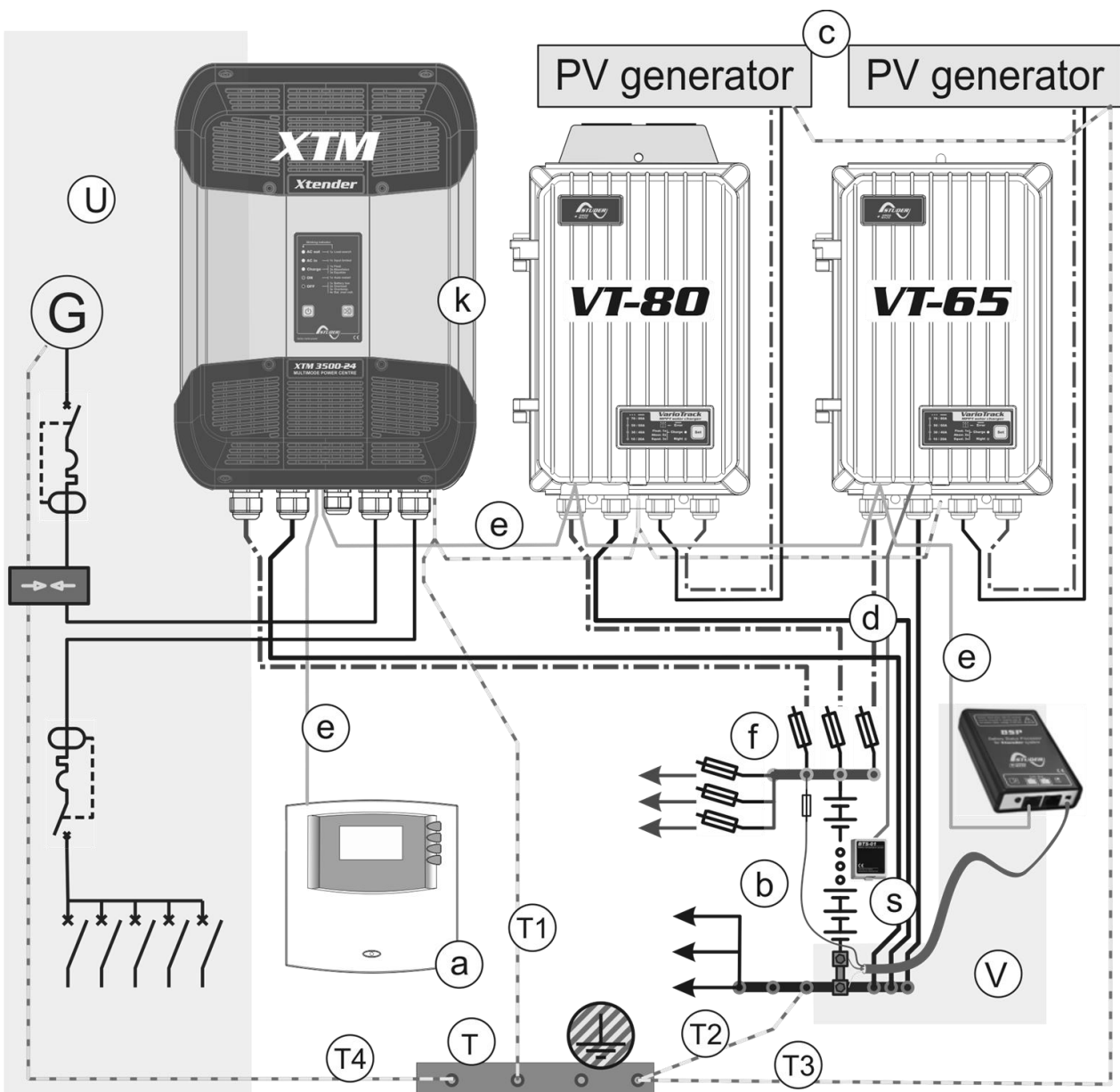

12 MAINTENANCE OF THE INSTALLATION

Except for the periodic check of the connections (tightening, general condition) the VarioTrack does not require any particular maintenance.

13 PRODUCT RECYCLING

The VarioTrack meets the European directive 2011/65/EU on hazardous substances and does not contain the following elements: lead, cadmium, mercury, hexavalent chrome, PBB or PBDE.

To dispose of this product, please use the service for the collection of electrical waste and observe all obligations in force in the place of purchase.

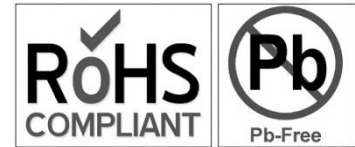

14 EC DECLARATION OF CONFORMITY

The charge regulator described in this manual has been designed and manufactured in accordance with the following directives and harmonized standards.

EMC directive: 2004/108/EU

Reference standard: EN 61000-6-3:2011, EN 61000-6-1:2007, EN 55014, EN 55022

Low voltage directive: 2006/95/EC

Reference standard: EN 62109-1:2010

RoHS directive: 2011/65/EU

CH -1950 Sion, 13 May 2014.

Studer Innotec SA (R. Studer)

A handwritten signature in black ink, appearing to read 'R. Studer'.

15 PARAMETER LIST

Level	User ref.	Parameter	Factory value	User value
Basic	10001	Voltage of the system	Automatic	
Expert	10002	Battery charge current	80 Adc	
Basic	10005	Floating voltage	13.6/27.2/54.4 Vdc	
Expert	10006	Force phase of floating	-	
Expert	10008	Absorption phase allowed	Yes	
Basic	10009	Absorption voltage	14.4/28.8/57.6 Vdc	
Expert	10010	Force absorption phase	-	
Expert	10011	Absorption duration	120 min	
Expert	10012	End of absorption triggered by the current	No	
Expert	10013	Current threshold to end absorption phase	10 Adc	
Basic	10017	Equalization allowed	No	
Expert	10018	Force equalization	-	
Expert	10019	Equalization before absorption phase	Yes	
Expert	10020	Equalization current	80 Adc	
Basic	10021	Equalization voltage	15.6/31.2/62.4 Vdc	
Expert	10022	Equalization duration	30 min	
Expert	10025	Days between equalizations	26 days	
Expert	10026	End of equalization triggered by the current	No	
Expert	10027	Current threshold to end equalization phase	10 Adc	
Expert	10029	Force a new cycle	-	
Expert	10030	Voltage level 1 to start a new cycle	12.2/24.4/48.8 Vdc	
Expert	10031	Time period under voltage level 1 to start a new cycle	30 min	
Expert	10032	Voltage level 2 to start a new cycle	11.8/23.6/47.2 Vdc	
Expert	10033	Time period under voltage level 2 to start a new cycle	2 sec	
Expert	10034	Cycling restricted	Yes	
Expert	10035	Minimal delay between cycles	1 hours	
Expert	10036	Temperature compensation	-3 mV/°C/cell	
Basic	10037	Synchronisation battery cycle with Xtender	Yes	
Expert	10039	ON of the VarioTrack	-	
Expert	10040	OFF of the VarioTrack	-	
Inst.	10043	Reset solar production counters	-	
Inst.	10044	Reset daily min-max	-	
Expert	10051	Reset of all VarioTrack	-	
Expert	10052	Equalization with fixed interval	Yes	
Expert	10054	Block manual programming (dip-switch)	No	
Basic	10056	Restore default settings	-	
Inst.	10057	Restore factory settings	-	
Inst.	10058	Parameters saved in flash memory	Yes	
Expert	10060	Check Earthing	No control	
Inst.	10087	Disabling of the display button	No	

16 PARAMETER LIST FOR THE AUXILIARY RELAYS

Level	User ref.	Parameter	Factory value	User value
Expert	10089	Operating mode (AUX 1)	Automatic	
Expert	10090	Combination of the events for the auxiliary contact (AUX 1)	Any (Function OR)	
Expert	10091	VarioTrack is OFF (AUX 1)	No	
Expert	10093	Activated in night mode (AUX 1)	No	
Expert	10094	Delay of activation after entering night mode (AUX 1)	1 min	
Expert	10095	Activation time for the auxiliary relay in night mode (AUX 1)	1 min	
Expert	10097	Battery undervoltage (AUX 1)	No	
Expert	10098	Battery overvoltage (AUX 1)	No	
Expert	10099	Earth fault (AUX 1)	No	
Expert	10100	PV error (48h without charge) (AUX 1)	No	
Expert	10102	Overtemperature (AUX 1)	No	
Expert	10104	Bulk charge phase (AUX 1)	No	
Expert	10105	Absorption phase (AUX 1)	No	
Expert	10106	Equalization phase (AUX 1)	No	
Expert	10107	Floating (AUX 1)	No	
Expert	10108	Reduced floating (AUX 1)	No	
Expert	10109	Periodic absorption (AUX 1)	No	
Expert	10111	Battery voltage 1 activate (AUX 1)	No	
Expert	10112	Battery voltage 1 (AUX 1)	11.7/23.4/46.8 Vdc	
Expert	10113	Delay 1 (AUX 1)	1 min	
Expert	10114	Battery voltage 2 activate (AUX 1)	No	
Expert	10115	Battery voltage 2 (AUX 1)	11.9/23.9/47.8 Vdc	
Expert	10116	Delay 2 (AUX 1)	10 min	
Expert	10117	Battery voltage 3 activate (AUX 1)	No	
Expert	10118	Battery voltage 3 (AUX 1)	12.1/24.2/48.5 Vdc	
Expert	10119	Delay 3 (AUX 1)	60 min	
Expert	10120	Battery voltage to deactivate (AUX 1)	13.5/27/54 Vdc	
Expert	10121	Delay to deactivate (AUX 1)	60 min	
Expert	10122	Deactivate if battery in floating phase (AUX 1)	No	
Expert	10124	Contact activated with the temperature of battery (AUX 1)	No	
Expert	10125	Contact activated over (AUX 1)	3 °C	
Expert	10126	Contact deactivated below (AUX 1)	5 °C	
Expert	10127	Only activated if the battery is not in bulk phase (AUX 1)	No	
Expert	10129	Contact activated with the SOC 1 of battery (AUX 1)	No	
Expert	10130	Contact activated below SOC 1 (AUX 1)	50 % SOC	
Expert	10131	Delay 1 (AUX 1)	12 h	
Expert	10132	Contact activated with the SOC 2 of battery (AUX 1)	No	
Expert	10133	Contact activated below SOC 2 (AUX 1)	30%	
Expert	10134	Delay 2 (AUX 1)	0.2 h	
Expert	10135	Contact activated with the SOC 3 of battery (AUX 1)	No	

Level	User ref.	Parameter	Factory value	User value
Expert	10136	Contact activated below SOC 3 (AUX 1)	20%	
Expert	10137	Delay 3 (AUX 1)	0 h	
Expert	10138	Contact deactivated over SOC (AUX 1)	90 % SOC	
Expert	10139	Delay to deactivate (AUX 1)	0.2 h	
Expert	10140	Deactivate if battery in floating phase (AUX 1)	No	
Expert	10141	Reset all settings (AUX 1)	-	
Expert	10143	Operating mode (AUX 2)	Automatic	
Expert	10144	Combination of the events for the auxiliary contact (AUX 2)	Any (Function OR)	
Expert	10145	VarioTrack is OFF (AUX 2)	No	
Expert	10147	Activated in night mode (AUX 2)	No	
Expert	10148	Delay of activation after entering night mode (AUX 2)	1 min	
Expert	10149	Activation time for the auxiliary relay in night mode (AUX 2)	1 min	
Expert	10151	Battery undervoltage (AUX 2)	No	
Expert	10152	Battery overvoltage (AUX 2)	No	
Expert	10153	Earth fault (AUX 2)	No	
Expert	10154	PV error (48h without charge) (AUX 2)	No	
Expert	10156	Overtemperature (AUX 2)	No	
Expert	10158	Bulk charge phase (AUX 2)	No	
Expert	10159	Absorption phase (AUX 2)	No	
Expert	10160	Equalization phase (AUX 2)	No	
Expert	10161	Floating (AUX 2)	No	
Expert	10162	Reduced floating (AUX 2)	No	
Expert	10163	Periodic absorption (AUX 2)	No	
Expert	10165	Battery voltage 1 activate (AUX 2)	No	
Expert	10166	Battery voltage 1 (AUX 2)	11.7/23.4/46.8 Vdc	
Expert	10167	Delay 1 (AUX 2)	1 min	
Expert	10168	Battery voltage 2 activate (AUX 2)	No	
Expert	10169	Battery voltage 2 (AUX 2)	11.9/23.9/47.8 Vdc	
Expert	10170	Delay 2 (AUX 2)	10 min	
Expert	10171	Battery voltage 3 activate (AUX 2)	No	
Expert	10172	Battery voltage 3 (AUX 2)	12.1/24.2/48.5 Vdc	
Expert	10173	Delay 3 (AUX 2)	60 min	
Expert	10174	Battery voltage to deactivate (AUX 2)	13.5/27/54 Vdc	
Expert	10175	Delay to deactivate (AUX 2)	60 min	
Expert	10176	Deactivate if battery in floating phase (AUX 2)	No	
Expert	10178	Contact activated with the temperature of battery (AUX 2)	No	
Expert	10179	Contact activated over (AUX 2)	3 °C	
Expert	10180	Contact deactivated below (AUX 2)	5 °C	
Expert	10181	Only activated if the battery is not in bulk phase (AUX 2)	No	
Expert	10183	Contact activated with the SOC 1 of battery (AUX 2)	No	
Expert	10184	Contact activated below SOC 1 (AUX 2)	50 % SOC	
Expert	10185	Delay 1 (AUX 2)	12 h	
Expert	10186	Contact activated with the SOC 2 of battery (AUX 2)	No	

Level	User ref.	Parameter	Factory value	User value
Expert	10187	Contact activated below SOC 2 (AUX 2)	30%	
Expert	10188	Delay 2 (AUX 2)	0.2 h	
Expert	10189	Contact activated with the SOC 3 of battery (AUX 2)	No	
Expert	10190	Contact activated below SOC 3 (AUX 2)	20%	
Expert	10191	Delay 3 (AUX 2)	0 h	
Expert	10192	Contact deactivated over SOC (AUX 2)	90 % SOC	
Expert	10193	Delay to deactivate (AUX 2)	0.2 h	
Expert	10194	Deactivate if battery in floating phase (AUX 2)	No	
Expert	10195	Reset all settings (AUX 2)	-	
Expert	10198	VarioTrack is ON (AUX 1)	No	
Expert	10199	VarioTrack is ON (AUX 2)	No	

17 TECHNICAL DATA

17.1 INPUT (PV GENERATOR)	VarioTrack VT-65	VarioTrack VT-80
Max. current of the solar generator	60A	75A
Max. voltage of the solar generator with a 12V battery	80V dc	
Max. voltage of the solar generator with a battery > 24V	150V dc	
Max. power of the solar generator	1000/2000/4000W ⁽¹⁾	1250/2500/5000W ⁽¹⁾
Peak efficiency	>99%	>99%
Own power consumption: operating/night	<5W/<1W	<5W/<1W

(1) In order to meet the National Electrical Code (NEC) in force in the United States, the maximum current for the solar generator is 52A for the VarioTrack model VT-65 and 64A for model VT-80.

(2) The generator power depends on various elements as well as on the voltage and power limits recommended in chapter 4.3.1

VarioTrack

17.2 OUTPUT (BATTERY)	VarioTrack VT-65	VarioTrack VT-80
Battery rated voltage	12V/24V/48V (automatic or manual setting)	
Battery input voltage range	7 - 68V	
Max. charging current of the battery at 25/40°C	65/60A	80/75A
"Night" mode consumption 12V-24V-48V	0.5W – 0.8W – 1.2W	
Charging phases: (adjustable threshold and duration)	Periodic or manual bulk, absorption, floating, equalization	
Battery temperature compensation	-3mV/°C/cell (ref. at 25°C)	

17.3 ENVIRONMENT	VarioTrack VT-65	VarioTrack VT-80
Dimensions (without cable-gland)	120 x 220 x 310 mm	120 x 220 x 350 mm
Weight	5,2 Kg	5,5 Kg
Degree of protection	IP 54, EN 60529:2001	
Operating range / Relative moisture	-20°C à 55°C / 95% without condensation	
Mounting place	indoor	
EC Conformity	EMC directive: 2004/108/EC EN 61000-6-3:2011, EN 61000-6-1:2007 Low voltage directive: 2006/95/EC: EN 62109-1:2010 RoHS directive: 2011/65/EU	
Communication	STUDER proprietary bus and protocol. Remote control and programming module RCC-02/03 Isolated RS 232 with Xcom-232i accessory.	

17.4 ELECTRONIC PROTECTION

Polarity reversal of the PV generator	Up to minus 150V
Polarity reversal on the battery side:	Up to minus 150V
Reverse current (night)	Disconnection by relays
Overvoltage on the battery side:	Up to 150V
Over temperature	Max 70°C => power reduction /stop

18 INDEX OF PARAMETERS

{10000}.....	31	{10097}.....	38	{10148}.....	38
{10001}.....	31	{10098}.....	38	{10149}.....	38
{10002}.....	23, 36	{10099}.....	38	{10150}.....	38
{10003}.....	32	{10100}.....	38	{10151}.....	38
{10005}.....	23, 24, 32, 33	{10102}.....	38	{10152}.....	38
{10006}.....	33	{10104}.....	38	{10153}.....	38
{10007}.....	33	{10105}.....	38	{10154}.....	38
{10008}.....	23, 33	{10106}.....	38	{10156}.....	38
{10009}.....	23, 24, 32, 33	{10107}.....	38	{10158}.....	38
{10010}.....	33	{10108}.....	39	{10159}.....	38
{10011}.....	23, 33	{10109}.....	39	{10160}.....	38
{10012}.....	23, 33	{10110}.....	39	{10161}.....	38
{10013}.....	33	{10111}.....	39	{10162}.....	39
{10016}.....	33	{10112}.....	39	{10163}.....	39
{10017}.....	23, 32, 34	{10113}.....	39	{10164}.....	39
{10018}.....	34	{10114}.....	39	{10165}.....	39
{10019}.....	24, 35	{10115}.....	39	{10166}.....	39
{10020}.....	23, 24, 34	{10116}.....	39	{10168}.....	39
{10021}.....	24, 32, 34	{10117}.....	39	{10169}.....	39
{10022}.....	23, 34	{10118}.....	39	{10170}.....	39
{10024}.....	34	{10119}.....	39	{10171}.....	39
{10025}.....	34	{10120}.....	39	{10172}.....	39
{10026}.....	34	{10121}.....	39	{10173}.....	39
{10027}.....	34	{10122}.....	39	{10174}.....	39
{10028}.....	35	{10123}.....	39	{10175}.....	39
{10029}.....	35	{10124}.....	39	{10176}.....	39
{10030}.....	35	{10125}.....	39	{10177}.....	39
{10032}.....	35	{10126}.....	39	{10178}.....	39
{10033}.....	35	{10128}.....	39	{10179}.....	39
{10034}.....	35	{10129}.....	39	{10180}.....	39
{10035}.....	35	{10130}.....	39	{10182}.....	39
{10036}.....	24	{10131}.....	39	{10183}.....	39
{10037}.....	21, 25, 32	{10132}.....	39	{10184}.....	39
{10038}.....	36	{10133}.....	39	{10185}.....	39
{10045}.....	35	{10134}.....	39	{10186}.....	39
{10052}.....	24	{10135}.....	40	{10187}.....	39
{10054}.....	25, 29, 36	{10136}.....	40	{10188}.....	39
{10056}.....	32, 36	{10137}.....	40	{10189}.....	40
{10060}.....	36	{10138}.....	40	{10190}.....	40
{10088}.....	37	{10139}.....	40	{10191}.....	40
{10089}.....	37	{10140}.....	40	{10192}.....	40
{10090}.....	37	{10141}.....	37	{10193}.....	40
{10091}.....	38	{10142}.....	37	{10194}.....	40
{10092}.....	38	{10143}.....	37	{10195}.....	37
{10093}.....	38	{10144}.....	37	{10198}.....	38
{10094}.....	38	{10145}.....	38	{10199}.....	38
{10095}.....	38	{10146}.....	38		
{10096}.....	38	{10147}.....	38		



Studer Innotec SA
Rue des Casernes 57
1950 Sion – Switzerland
Tel: +41 (0) 27 205 60 80
Fax: +41 (0) 27 205 60 88

info@studer-innotec.com
www.studer-innotec.com