

ENGINEERING  
TOMORROW

*Danfoss*

Instruction Manual

# Danfoss Eco™ Electronic radiator thermostat



[www.danfoss.com](http://www.danfoss.com)

**Installation Guide****1. Installation**

1.1	Identify your Danfoss Eco™	4
1.2	In the package	5
1.3	Overview of valve adapters	5
1.4	Installing the right adapter	7
1.5	Inserting the batteries	8
1.6	Mounting the Danfoss Eco™	9
1.7	Download Danfoss Eco™ App	9
1.8	Pairing Danfoss Eco™	10
1.9	Automatic adjustments	10
1.10	Removing Danfoss Eco™	11
1.11	Resetting Danfoss Eco™ to default settings	11

<b>2. Technical specifications</b>	<b>12</b>
------------------------------------	-----------

## User Guide

### 3. Display

3.1	Display screen .....	13
3.2	Red illuminating ring .....	13
3.3	Display rotation .....	14
3.4	Manual mode .....	14

### 4. Temperature and programme settings

4.1	Time .....	15
4.2	Default temperature .....	15
4.3	Setting temperatures .....	15
4.4	Create your own schedule .....	16
4.5	Vacation .....	16
4.6	Overrule a vacation .....	17
4.7	Cancel an existing vacation programme .....	17
4.8	Pause .....	17
4.9	Open window setting .....	18

### 5. Additional settings

5.1	Setting options via the Danfoss Eco™ App .....	19
5.2	Software updates .....	20
5.3	Data security .....	21

### 6. Safety precautions .....

### 7. Disposal .....

# 1. Installation





## 1.1 Identify your Danfoss Eco™

Code no.	Version characteristics
<b>014G1000</b>	Adapters included: RA adapter
<b>014G1001</b>	Adapters included: RA, M30 x 1.5 adapters
<b>014G1002</b>	IT - Adapters included RA, M30, Caleffi & Giacomini
<b>014G1003</b>	RU - Adapters included RA & M30
<b>014G1020</b>	UK (Combi, Bi-Div valve) - RA (Premounted)
<b>014G1021</b>	UK (Combi, Bi-Div valve, RLV-D) - RA (Premounted)

Code no.	Version characteristics
<b>014G1100</b>	DK - Adapters included RA, M30, RAV & RAVL
<b>014G1101</b>	DE - Adapters included RA, M30, RAV & RAVL
<b>014G1102</b>	FR - Adapters included RA, M30, M28 Comap
<b>014G1103</b>	HU, HR, RO, SK, UA - Adapters included RA, M30, RTD
<b>014G1104</b>	IT - Adapters included RA, M30, M28 Herz, Caleffi & Giacomini
<b>014G1105</b>	PL, CZ, LT, EE, LV, SI - Adapters included RA, M30 & RTD
<b>014G1106</b>	NL, BE, NO, FI, IS, TR - Adapters included RA & M30
<b>014G1107</b>	ES, PT - Adapters included RA, M30, M28 Orkli
<b>014G1108</b>	UK - Adapters included RA, M30
<b>014G1109</b>	AT - Adapters included RA, M30 & M28 Herz
<b>014G1110</b>	SE - Adapters included RA, M30 & M28 MMA
<b>014G1111</b>	RU - Adapters Included RA, M30, RTD, M28 Herz & Giacomini
<b>014G1112</b>	CH - Adapters included RA, M30, RAVL & RAV

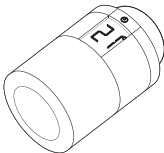

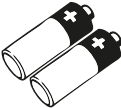
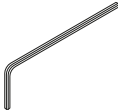
## 1.2 In the package

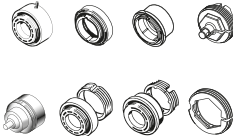

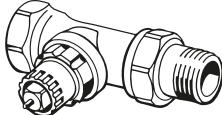

Danfoss Eco™ are supplied with the adapters as listed above. In addition each pack contains:

			
<i>Danfoss Eco™</i>	<i>Quick Guide</i>	<i>Requires 2x AA batteries</i>	<i>Allen Key</i>
			
<i>Adapter Guide</i>	<i>Adapters</i>		

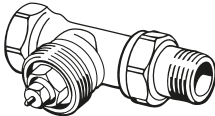
## 1.3 Overview of valve adapters

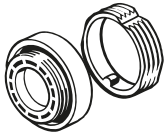
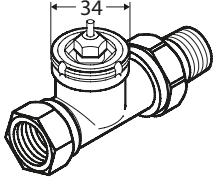
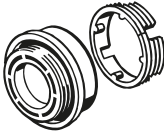
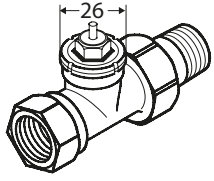
Adapters for a wide range of different valve types are available as accessories.

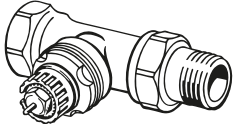
Adapter type	Code no.	Adapter	Valve
For Danfoss RA valves	014G0251		
For M30 x 1.5 (K) valves	014G0252		

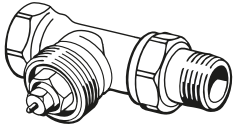
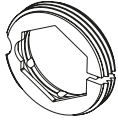
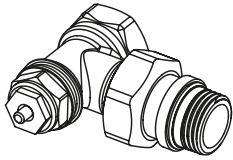
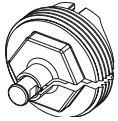
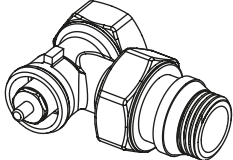
For Danfoss RAV valves	014G0250		
For Danfoss RAVL valves			
For Danfoss RTD valves	014G0253		
<b>For M28 valves:</b>			
- MMA	014G0255		
- Herz	014G0256		
- Orkli	014G0257		
- COMAP	014G0258		
For Caleffi valves	013G5849		
For Giacomini valves	013G5849		

### 1.4 Installing the right adapter

The Danfoss Eco™ pack contains an adapter guide to help you find the correct adapter for your valve. If you need additional help in finding the correct adapter follow the QR code on the guide and follow the video instruction.

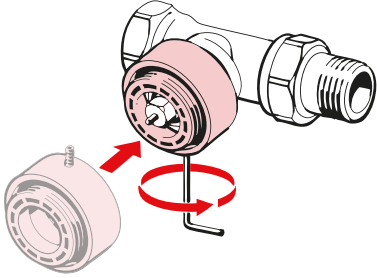
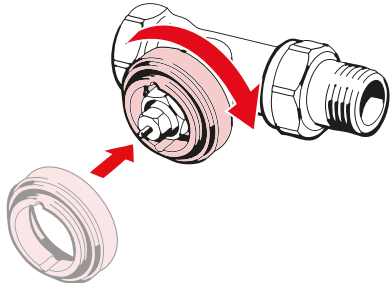
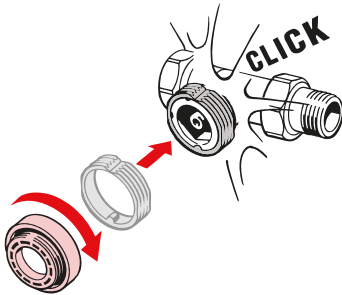
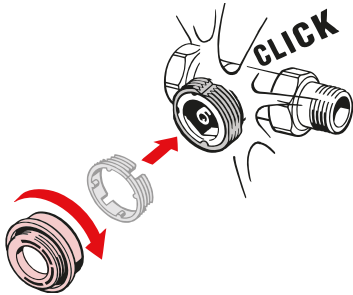
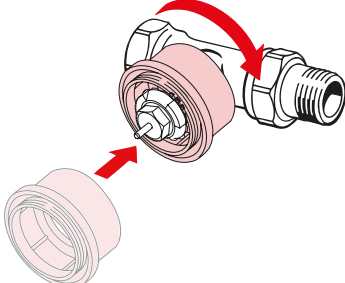
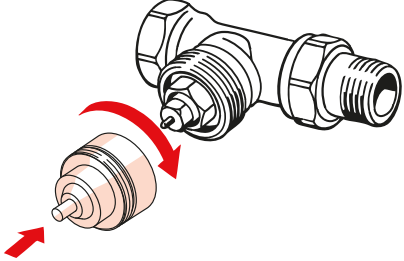
<p><b>Adapter for RA valves</b></p> 	<p><b>Adapter for M30 x 1.5 (K) valves</b></p> 
<p><b>Adapter for RAV valves</b></p> 	<p><b>Adapter for RAVL valves</b></p> 
<p><b>Adapter for RTD valves</b></p> 	<p><b>Adapters for M28 valves</b></p> 

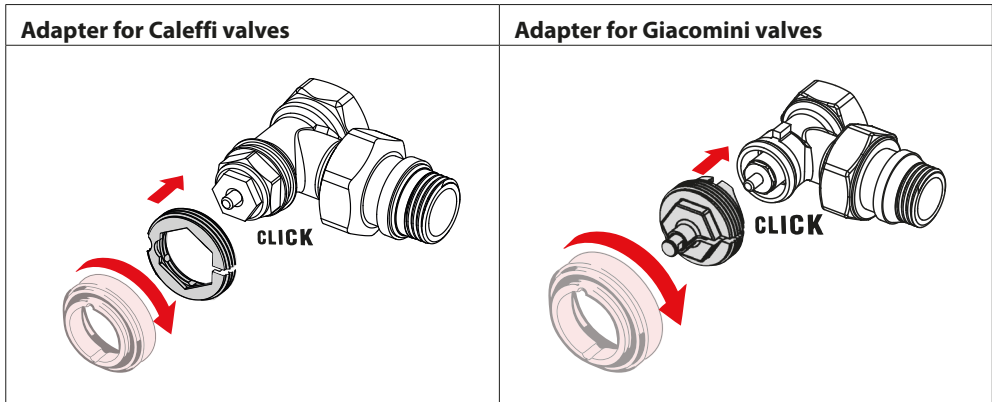

### 1.5 Inserting the batteries

Remove the battery cover as shown in the diagram and insert two AA batteries. Make sure the batteries are correctly oriented.

Rechargeable batteries **must not** be used.

When replacing batteries the time and date settings are lost immediately. After replacing batteries re-connect to a smartphone to activate a schedule. The red ring will flash. Re-connect to the App and the time and date will be restored. If you do not re-connect the sensor will remain in manual mode.

The low battery symbol  is displayed approx. one month before the batteries run out.

Before the batteries run out Danfoss Eco™ will leave the valve in Frost Protection position to protect the heating system from damage. Estimated battery life time is up to 2 years.

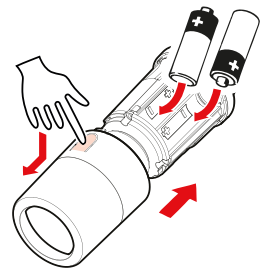



### 1.6 Mounting the Danfoss Eco™

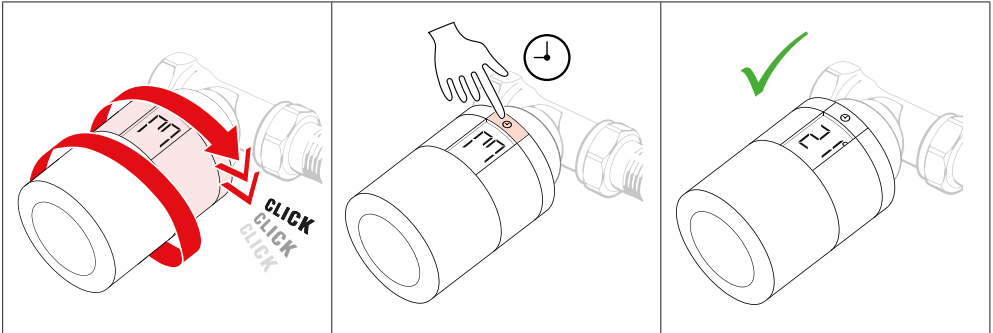

Screw the Danfoss Eco™ onto the mounted adapter until a click sound appears. Once the thermostat is tightened properly, then adjust the display to your preferred display orientation. A large **77** is flashing in the display to indicate that Installation Mode is activated. Press and hold the button for 3 seconds. The temperature set point will show on the screen once the Danfoss Eco™ is mounted.

### 1.7 Download Danfoss Eco™ App

Download the Danfoss Eco™ App.

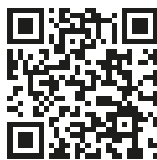

## 1.8 Pairing Danfoss Eco™

*Note, Turn on Bluetooth on your smart phone to connect to the Danfoss Eco™.*

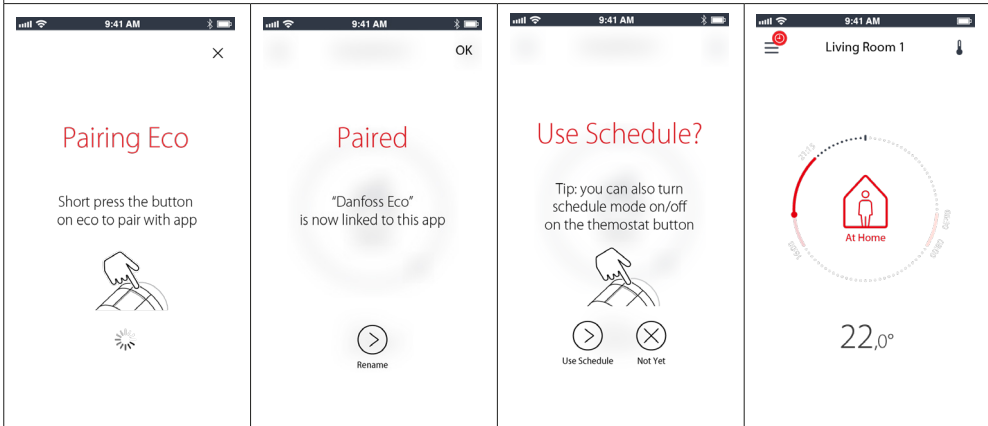

Follow the prompts from the Danfoss Eco™ App to pair your Danfoss Eco™. Bluetooth range is 10m (depending on the building construction and surroundings).

## 1.9 Automatic adjustments

When Danfoss Eco™ is installed it will automatically begin to adjust itself to your heating system, during the first week after installation. During this process you might experience that the thermostat reacts slowly or turns the heat up and down by itself. This is normal and a necessary part of the adjustment process.

### 1. Adjusting to the valve

During the first night of operation Danfoss Eco™ will shut off the radiator heat and then open again to detect the exact opening point of the valve. This will allow Danfoss Eco™ to control the heat as efficiently as possible. If necessary, the procedure is repeated once a night for up to a week.



### 2. Adaptive Learning

If you activate Adaptive Learning Danfoss Eco™ learns during the first week of operation when it is necessary to start heating the room in order to reach the correct temperature at the correct time.

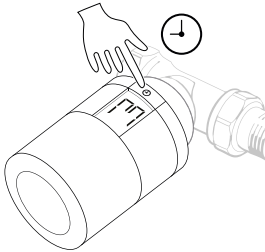

The intelligent control will continuously adjust the heating time compared to seasonal temperature changes.

Using Saving Program requires that your heating system has enough heat for a short period during heat up. If you experience problems you should contact your installer.

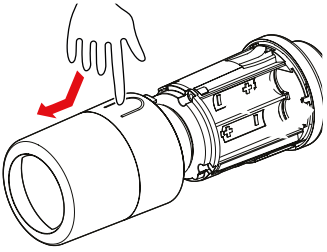
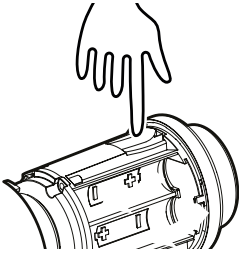

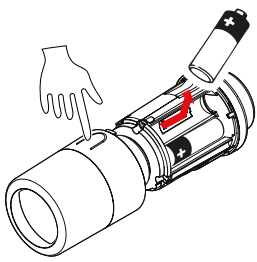
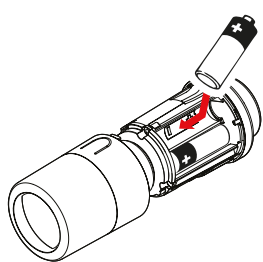

### 1.10 Removing Danfoss Eco™

<p>1.</p>  <p>Press and hold  until large  flashes. This indicates you are in mounting mode</p>	<p>2.</p>  <p>Remove the cover.</p>
<p>3.</p>  <p>Press firmly on the tab and unscrew the thermostat from the adapter.</p>	

### 1.11 Resetting Danfoss Eco™ to default settings

<p>1.</p>  <p>Remove the cover and take out one battery.</p>	<p>2.</p>  <p>Press and hold , Keep holding while reinserting the battery. The screen will go blank after approx 3 seconds.</p>
---	--

## 2. Technical specifications

Thermostat type	Programmable electronic radiator valve controller
Recommended use	Residential (pollution degree 2)
Actuator	Electromechanical
Display	LCD with white backlight
Software classification	A
Control	PID
Power supply	2 x 1.5 V alkaline AA batteries (not included)
Power consumption	3 µW in standby 1.2 W when active
Trasmission Frequency / Power	2,4 GHz / <2,1mW
Battery life	Up to 2 years
Low battery signal	Battery icon will flash in display. If battery level is critical the red ring will flash.
Ambient temperature range	0 to 40 °C
Transportation temperature range	-20 to 65 °C
Maximum water temperature	90 °C
Temperature setting range	4 to 28 °C
Measurement interval	Measures temperature every minute
Clock accuracy	+/- 10 min/year
Spindle movement	Linear, up to 4.5 mm, max. 2 mm on valve (1 mm/s)
Noise level	<30 dBA
Safety classification	Type 1
Open-window function	Activated at temperature decrease.
Weight (incl. batteries)	198 g (with RA adapter)
IP class	20 (not to be used in hazardous installations or in places where it will be exposed to water)
Approvals, markings etc.	   

### 3. Display

#### 3.1 Display Screen

Short press on and the Display Screen appears. Danfoss Eco™ is displaying the **set temperature**, not the **measured room temperature**.

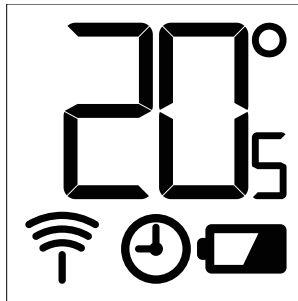

**Display symbols:**

	Installation Mode must always be activated when installing or removing Danfoss Eco™. The thermostat may be irreparably damaged if not in the correct position during installation.
	Temperature is shown in degrees celcius. Danfoss Eco™ is displaying the <b>set temperature</b> , not the <b>measured room temperature</b> .
	Scheduled Mode
	The antenna symbol flashes when you need to connect the App to the thermostat. If you are connected, the red ring will illuminate (the display will be blank).
	low battery. Battery icon will flash in display. If battery level is critical the red ring will flash.

#### 3.2 Red illuminating ring

The red ring will be constantly on when you are connected to the Danfoss Eco™ App. It also flashes to indicate when the batteries are critically low on power.

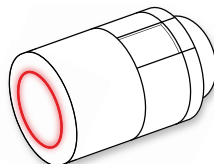

### 3.3 Display rotation

Danfoss Eco™ can be mounted in a horizontal or vertical position, depending on your radiator valve. You can set the display rotation to either 'horizontal' or 'vertical' within the Danfoss Eco™ App under Advanced Settings.

### 3.4 Manual mode

Danfoss Eco™ can be used without the Danfoss Eco™ App in Manual Mode.

**Functionality is reduced.**

Use the handwheel to adjust the temperature. The display shows the required temperature and not the room temperature. In manual mode there are no comfort or setback temperatures or times set.

## 4. Schedules and Temperatures





### 4.1 Time

The device will take the correct time from your smart phone. There is no need to set the time. Danfoss Eco™ uses a 24 hour time display.

**Note.** *If the batteries have been removed from the Danfoss Eco™ you will need to connect to the Danfoss Eco™ App to correct the time once the batteries are replaced.*

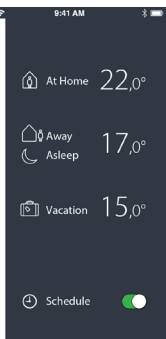
### 4.2 Default temperature

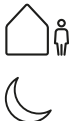
The default temperatures for Danfoss Eco™ are as below:

	Icon	Name	Default Temperature
		At Home	21°C
		Away / Asleep	17°C
		Vacation	15°C

The default temperatures can be changed in the Danfoss Eco™ App.

### 4.3 Setting temperatures

Set your own temperatures for your setback periods in the Danfoss Eco™ App.

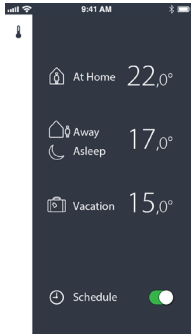
	<p>Scroll on temperatures to set your preferred temperatures. The Danfoss Eco™ can be set from 5°C to 28°C. Danfoss recommend a difference between 'At Home' temperature and 'Away/Asleep' that does not exceed 4 degrees.</p> <p><b>Note.</b> <i>Changes in temperature from the home screen are temporary (Until next setback period)</i></p>
---	---

### 4.4 Create your own schedule

<p>Within the Danfoss Eco™ App you can create your own schedule. You can choose any setback times within 24 hours and a maximum of 3 setback periods per day.</p>	<p>The weekly schedule shows the 'At Home' periods in red. The 'copy' functionality allows you to copy the schedule you have created to other days.</p>	<p>The Danfoss Eco™ App display shows both the 24 hour clock wheel, showing your At Home time in red and a summary of your schedule, with the detailed times set. The minimum At Home period is 30 minutes.</p>

### 4.5 Vacation

A Vacation programme keeps the setback temperature for a period, defined by you. Use a Vacation programme to save energy, when you are away from home. Vacation programme is set within the Danfoss Eco™ App.

<p>Vacation mode can be planned or set straight away (Now).</p>	<p>Planned Vacations use a calendar and time setting.</p>	<p>Schedule your Vacation in the Danfoss Eco™ App.</p>	<p>The Danfoss Eco™ App display confirms your Vacation date.</p>



### 4.6 Overrule a vacation

If returning earlier than expected you might wish to shift from the Vacation programme to your normal schedule.

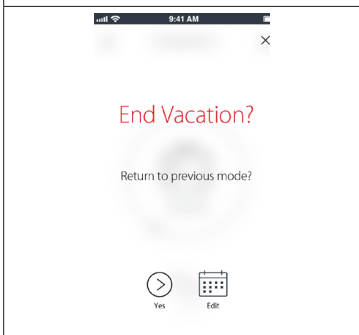

When in 'Vacation' setting the Danfoss Eco™ App will give options to end the Vacation period or edit the dates and times.

### 4.7 Cancel an existing vacation programme

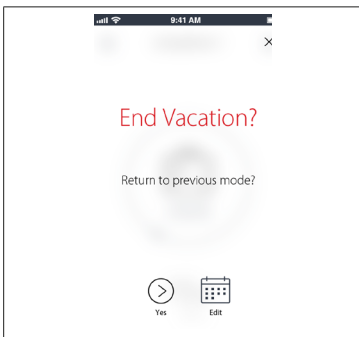

If the Vacation is planned for the future you can simply edit the dates or cancel the programme.

### 4.8 Pause

The Pause programme keeps the setback temperature until another programme is selected.

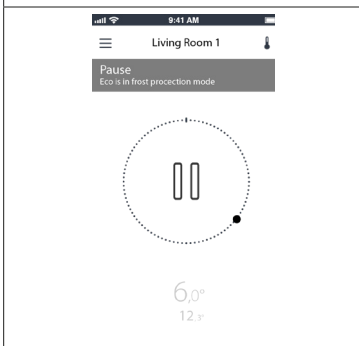

When Danfoss Eco™ is turned down to Min level manually, a notification banner is shown, and center icon switches to 'Pause'.

To exit Pause click the centre icon on the Danfoss Eco™ App and return to the scheduled or manual setpoint.

#### 4.9 Open window function

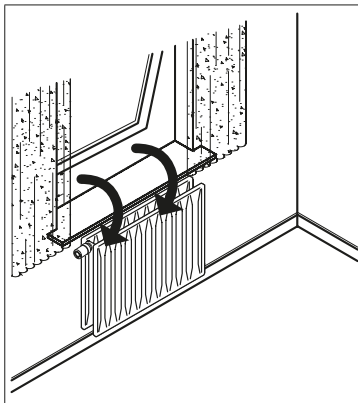

Danfoss Eco™ features an Open-window function, which closes the valve if the room temperature is falling dramatically, thus reducing the heat loss. The heat is turned off for up to 30 minutes, before Danfoss Eco™ returns to its original settings. When Open-window has been activated, the function is quarantined for 45 minutes.

***Note! Be aware that the Open-window function will be affected, if curtains or furniture are covering Danfoss Eco™, preventing it from detecting the decreasing temperature.***

## 5. Settings & Installation modes

### 5.1 Setting options via the Danfoss Eco™ App

	<i>Command</i>	<i>Options</i>
<b>Thermostats</b>	<i>List of the installed Danfoss Eco™ thermostats (by name)</i>	<i>Option to change the name of the Danfoss Eco™ or to un-pair an existing Danfoss Eco™.</i>
	<i>Add Danfoss Eco™</i>	<i>Option to add another Danfoss Eco™</i>
<b>Restrictions</b>	<i>PIN Code</i>	<i>Option to add a PIN code to the Danfoss Eco™ App</i>
	<i>Change PIN Code</i>	<i>Option to change PIN code</i>
	<i>Child Lock</i>	<i>To protect your Danfoss Eco™ activate the Child Lock, once activated the Danfoss Eco™ can only be adjusted by the Danfoss Eco™ App and the Manual function is overridden.</i>
	<i>Min/Max Temperatures</i>	<i>Limit the temperature range. The MIN/MAX settings are adjusted by scrolling the temperatures in the Danfoss Eco™ App.</i>
<b>Advanced Settings</b>	<i>Adaptive Learning</i>	<i>Adaptive Learning ensures you get the temperature you asked for at the right time. Adaptive Learning uses historical data to determine how fast (degrees/hour) each room can be reheated.</i>
	<i>Heat Control</i>	<i>The Heat Control ensures that Danfoss Eco™ reaches the comfort temperature on time, according to the schedule. Options are for Moderate or Quick. Moderate ensures sufficient return temperature.</i>
	<i>Display Rotation</i>	<i>The Danfoss Eco™ display can be rotated by 180°. This allows the display to be read from horizontal and vertical mounting.</i>
	<i>Mode</i>	<i>Mounting Mode</i>
	<i>Frost Protection</i>	<i>The minimum temperature to protect your heating system. Set between 4-10°C.</i>
<b>System Information</b>	<i>Software version information</i>	<i>Confirms the latest software version of the Danfoss Eco™ App that is downloaded to your device.</i>
<b>EULA</b>	<i>Legal information</i>	<i>Full terms and conditions of the Danfoss Eco™ App.</i>

<b>Help</b>	<i>Topics</i>	<i>Links to the FAQ site for the main help topics for troubleshooting issues with your Danfoss Eco™.</i>
	<i>Show Introduction Screens</i>	<i>Plays the introduction screens that first appear when you download the Danfoss Eco™ App.</i>
	<i>Demo Mode</i>	<i>Try the Danfoss Eco™ App with the Demo Mode feature. This will not adjust the Danfoss Eco™ but will show the screens and functionality within the Danfoss Eco™ App. NB. To exit the Demo Mode double click on the word 'Demo' on the Danfoss Eco™ App screen.</i>

## 5.2 Software Updates

Danfoss Eco™ thermostat can be updated via the Danfoss Eco™ App  
The Danfoss Eco™ App will inform when a new software is available.

**Update failed – there is no response from the thermostat. The display is blank and no light is illuminating the red ring.**

<p>If the update failed, you have to open the thermostat list. Do that by closing the App completely, or simply press the thermostat name in the top of the home screen.</p>	<p>Unknown thermostat' should appear on the list.  Choose 'Unknown device'</p>	<p>Press install</p>	<p>Stay close to the thermostat</p>

### 5.3 Data Security

The data security for of the Danfoss Eco™ thermostat and Danfoss Eco™ App, that is paired to your smartphone is guaranteed. The system is tested annually by independent specialists.

**Data encryption:** The wireless connection to your Danfoss Eco™ thermostat is protected against threats from unknown devices with latest encryption technology, and first time pairing with the thermostat can only be done by physically pressing the button on the thermostat.

**Security through PIN code:** A PIN code assigned by the user ensures that only authorized persons can make changes to the system.

**User Personal data** such as temperature or set-points are only stored in the thermostat, so therefore only your personal App can access this.

In addition to the security functions that ensure data protection at any point during the data transmission from your smartphone to the Danfoss Eco™ thermostat, we ensure the highest level of security with further technical and organizational measures. Danfoss continuously checks and develops these further.

### 6. Safety precautions

The thermostat is not intended for children and must not be used as a toy.

Do not leave packaging materials where children may be tempted to play with them, as this is extremely dangerous.

Do not attempt to dismantle the thermostat as it contains no user-serviceable parts.

Do not remove the cover to clean the thermostat. The external cover can be cleaned with a soft cloth.

### 7. Disposal

The thermostat must be disposed of as electronic waste.



**Danfoss A/S**

Haarupvaenget 11

DK-8600 Silkeborg

Denmark

Phone: +45 7488 8000

Fax: +45 7488 8100

[www.danfoss.com](http://www.danfoss.com)