

OLYMPIA ® Protect 9xxx Wireless Alarm System



Operating Manual

05.2015 en rev.03

Olympia Business Systems Vertriebs GmbH
Zum Kraftwerk 1
45527 Hattingen

Introduction	5	Configuration	18
Guarantee	5	Navigating Through the Menu	18
User Information	5	Language	18
Exemption From Liability	5	Date and Time	18
Intended Use	6	PIN (Personal Identification Number)	18
Product Features	6	Key Lock	19
Scope of Delivery	7	Individual Outgoing Messages	19
Warnings	7	GSM Dialling Unit	20
Installation	9	Trigger Delay	24
Information on Selecting the		Arming Delay	24
Installation Location	10	Alarm Period	24
Preparing and Connecting the Base Unit ...	10	Key Tone	25
Positioning the Base Unit	11	Display Contrast	25
Operating Elements and Indicators	12	Remote Control	25
Keys on the Base Unit	12	Water Leak (Flood) and Smoke Detectors ..	26
Display Icons	14	Registering Sensors	26
Overview of LEDs	15	Deregistering Sensors	27
Buttons on the Remote Control	15	Resetting the Factory Settings (RESET)	27
Menu Structure	16		

Monitoring Functions 28

Switching the Monitoring Functions On/Off ..	28
Alarm Mode	29
At Home Mode	29
PIR At Home Mode	29
Silent Mode	30
Disarmed Mode	30
Panic Alarm	30
Emergency Call (SOS)	31
Remote Access Via Telephone	31

Appendix 32

System Extension	32
Changing the Batteries	32
Regular Maintenance and Service	34
Information on Disposal	34
Technical Data	35
Technical Modifications	36
CE Mark	36
Newsletter	36
Manufacturer	36

Introduction

Guarantee

Dear Customer,

We are pleased that you have chosen an Olympia wireless alarm system from the Protect 9XXX Series with emergency call, panic, screening and handsfree functions. Should a technical problem arise with regard to the equipment, please observe the following points:

The period of guarantee for the equipment is 24 months.

It is essential to keep the purchase receipt and original packing.

Should a problem occur, first of all, call our hotline: 0180 5 007514 (cost via German landline at time of going to print: 14 ct/min.; max. 42 ct/min. via mobile networks). Our expert personnel can frequently provide help over the phone.

However, if the problem cannot be solved via telephone, please send the equipment to the following address in its original packaging:

Service-Center Hattingen
Zum Kraftwerk 1
45527 Hattingen

Repairs under the terms of guarantee can only be completed when the purchase receipt is enclosed.

User Information

The alarm system is a passive security product and has been conceived as a deterrent. Additional measures are necessary to prevent and hinder burglary and theft. You can obtain all the necessary information on this from your local police station.

Read the operating instruction manual thoroughly before connecting and starting the system for the first time. The operating instruction manual will help prevent application errors and, at the same time, ensure you can exploit all the technical options provided by the wireless alarm system to the full.

Exemption From Liability

We cannot guarantee that the information which relates to the technical properties of the product or to the product itself contained in this document is correct. The product and its accessories described in this document are subject to constant improvement and further development. For this reason, we reserve the right to modify components, accessories, technical specifications and related documentation of the product described herein at any time without notice.

Intended Use

The wireless alarm systems from the Protect 9XXX Series enable you to monitor rooms and buildings as long as the local conditions are such that they enable a reliable transmission link to the sensors (e.g. door/window contact, smoke detector). In addition, all doors and windows must be equipped with door/window contacts. A condition for complying with the intended use is that the equipment is installed correctly and the information in the instruction manual is observed and maintained.

Any other use is considered unintended use. Unauthorised modifications or reconstructions not described in the operating manual are not permitted and could cause the product to be damaged. Furthermore, risks through short-circuits, fire, electric shock etc. cannot be ruled out.

- **i** This operating instruction manual contains important information on setting up and handling the equipment. The manual must be enclosed with the equipment if handed over to others.

Product Features

- Wireless alarm system with emergency call, panic, screening and handsfree functions.
- Integrated GSM dialling unit with outgoing message for alarm messages via the mobile network.
- Up to 10 alarm call numbers and 1 emergency call number (SOS).
- Individual voice message for each sensor.
- Automatic dialling of the next number when the number called is "engaged".
- Handsfree function on the base unit in the case of an SOS.
- Alarms can be issued via the telephone (silent alarm) individually or combined.
- Large LC display, 1 numeric line in 7 segments for 24 characters, 1 alphanumeric line in 5x7 dot matrix for 13 characters, 11 icons as status indicators.
- Display lighting in yellow and blue.
- Warning in the case of a low battery charge.
- Power failure backup in the base unit.
- Base unit has a remote control facility.
- Upgradable for operation with max. 32 sensors.
- Simple integration of new sensors using plug-and-play technology.

Scope of Delivery

Please check the contents of the package carefully. If anything is missing or has been damaged during transport, DO NOT put the wireless alarm system into operation!

Keep the packaging in a safe place to protect the equipment from damage should it need to be dispatched in future.

Base unit	1
Power adapter plug	1
Remote control	1
Batteries	3 x alkaline AAA 1 x lithium CR2430 3 V
Assembly material	Screws, dowels, adhesive tape
Operating manual	1

Warnings

The following warning information applies to the entire document. Read and observe all the warning information to protect yourself and the environment from any harm.

The following warning information indicates potentially dangerous situations which could lead to **serious** injuries or even **fatal** injuries if the information is ignored.



WARNING!

- Risk of fatal injury from electric shock!
- ➔ NEVER use the device if you suspect damage to the power cable or power plug or there are visible signs of damage to the power cable or power plug.
- ➔ NEVER complete any repairs to the device yourself. Contact our Service department.
- ➔ Only use the device at those installation locations described in Chapter "Installation".



WARNING!

- Risk of suffocation!
- ➔ Children can swallow small parts, packaging and protective foils.
- ➔ Keep the device and packaging out of reach of children.

Warnings

WARNING!

- Risks to health through batteries!
- ➔ Keep batteries out of reach of children. Do not swallow batteries. If any type of battery is swallowed, seek medical attention immediately.

WARNING!

- Risk of explosion!
- ➔ Improper storage of batteries can put your health and the environment at risk. Batteries may contain toxic, ecologically hazardous heavy metals.
- ➔ Never open, damage or swallow batteries or allow them to pollute the environment.

The following warning information indicates potentially dangerous situations which could lead to **minor** or **slight** injuries if the information is ignored.

CAUTION!

- Hearing damage through loud alarm signal!
- ➔ Due to legal requirements, the alarm signal continues for maximally 120 seconds. The alarm signal switches off automatically after approx. 120 seconds if the user does not interrupt it.
- ➔ Use ear protectors when testing the device.
- ➔ Do not remain in the vicinity of the acoustic alarm for a longer period when it has been triggered.

The following warning information indicates potentially dangerous situations which could lead to **property damage** if the information is ignored.

ATTENTION!

- Property damage through the use of inappropriate batteries!
- ➔ The use of inappropriate batteries can cause a loss of function of the device.
- ➔ Only use batteries of the type described in Section "Technical Data".

ATTENTION!

- Property damage through environmental influences!
- ➔ Prevent environmental influences such as exposure to smoke, dust, vibration, chemicals, moisture, heat and direct sunlight.

Installation

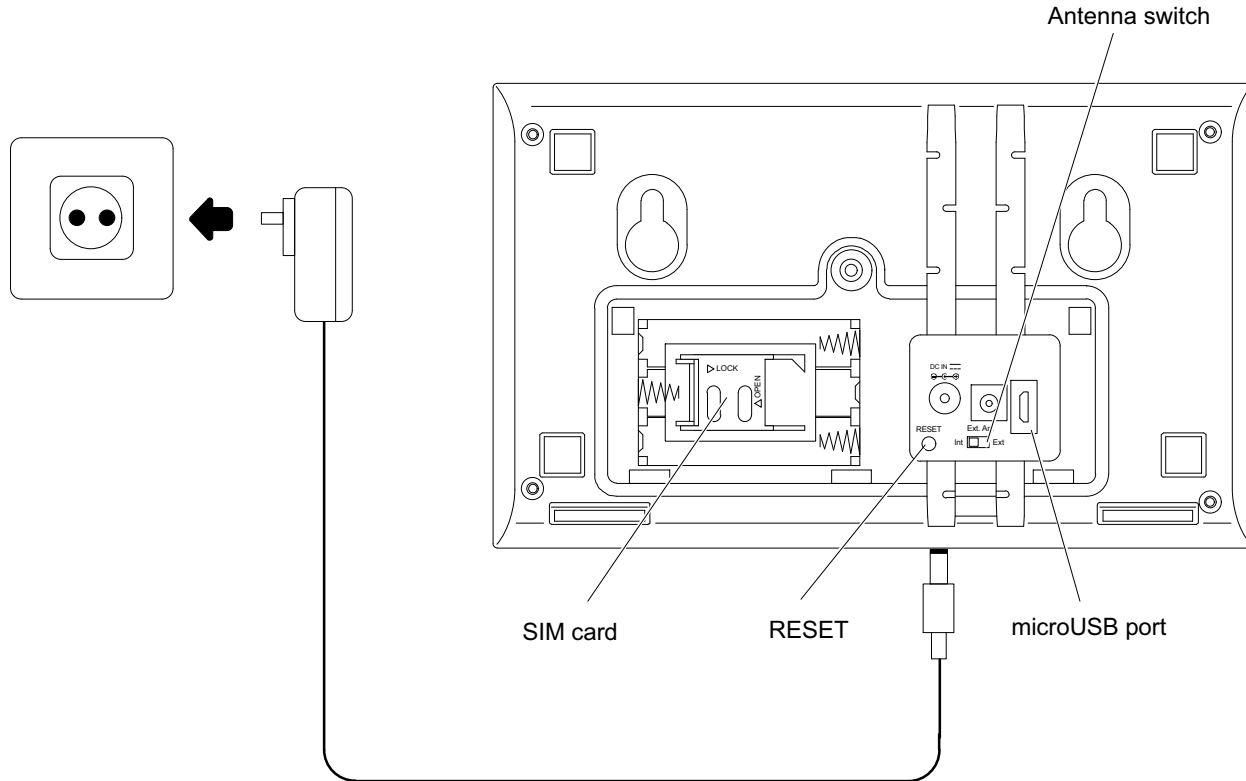

Installation

Information on Selecting the Installation Location

Do not place the base unit on or in the direct vicinity of large metallic objects or electrical sources of interference which could impair the function of the base unit. Examples of sources of interference include radiators, concrete steel walls, metal doors, loudspeaker systems, motors and other unshielded electronic devices.

- Position the base unit as centrally as possible in the area to be monitored to ensure optimum radio transmission of all components.
- Position the base unit near a properly installed power socket (230 V / 50 Hz).
- Position the base unit and alarm system components in such a way that a distance of at least 20 cm is maintained to you and/or other persons. This is a useful way of reducing any exposure to radio waves.
- Position the base unit in an area which, when accessed, triggers the alarm. This prevents intruders being able to approach the base unit and manipulate it.

Preparing and Connecting the Base Unit

1. Use a screwdriver to loosen the screw in the battery and connection socket compartment on the underside of the base unit.
2. Remove the cover from the battery and connection socket compartment.

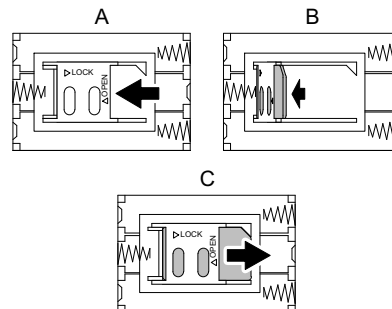

3. Slide the SIM card holder to the left to unlock it (A).
4. Pivot the holder up and insert the SIM card in the holder (B).
5. Pivot the holder with the SIM card back and slide the holder to the right to lock it (C).
6. Insert three batteries in the battery compartment (pay attention to correct polarity).

i The use of batteries serves as a safeguard against failure. In the case of normal power supply using the power adapter plug, the batteries are not affected. In the event of a power failure, the base unit is battery powered until the power supply is restored.

7. Set the Antenna switch to **Int**.
8. Connect the power adapter plug to the base unit.
9. Place the cover on the battery and connection socket compartment and tighten the screw in the battery and connection socket compartment.

Positioning the Base Unit

It is possible to setup the device in a user-friendly, inclined position on a table or desk. To do this, insert the two legs (1) supplied in the recesses for the wall installation bracket (2) on the rear of the base unit.

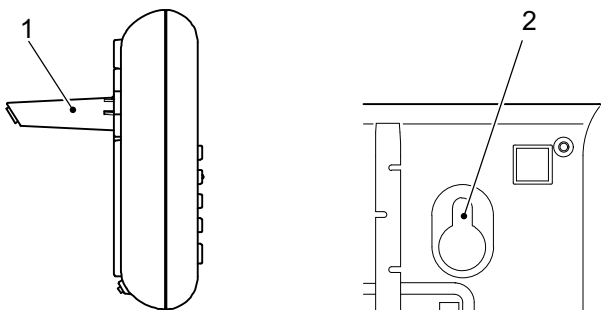

Installing the Base Unit on a Wall

After having found a suitable location for the base unit, you can begin with the installation.

⚠ WARNING!

- Risk of fatal injury through electric shock or gas explosion!
- ➔ During installation, pay attention to the possibility of electrical cables and gas pipes running in the walls.
- ➔ Pay attention that you do not damage electric cables or gas pipes.

1. At the installation location, insert two screws in the wall, 100 mm apart and aligned horizontally. (It may be necessary to drill the holes first and then insert dowels in which to tighten the screws, depending on the properties of the wall.)
2. Screw the screws in the wall using a screwdriver until there is approx. 3 mm clearance from the bottom edge of the screw head to the wall.
3. Hook the recesses in the wall bracket (2) for the base unit over the screws.
4. Plug the power adapter in a properly installed power socket. The base unit is then ready to use.

Operating Elements and Indicators

Operating Elements and Indicators

The base unit is equipped with an SOS (emergency call) button **SOS** for use in emergency situations and a Panic button  for use in the event of a direct threat. The remote control unit is provided with a button which can be configured either as an Emergency Call or Panic button (refer to "Configuring the Remote Control").

The Panic button  triggers an acoustic alarm immediately, regardless of whether the alarm system is armed or not. The acoustic alarm can be switched off via the base unit or the remote control.





The SOS button **SOS** activates the GSM dialling unit if phone numbers of contact persons have been entered and saved. Activation is independent of whether the alarm system is armed or disarmed.



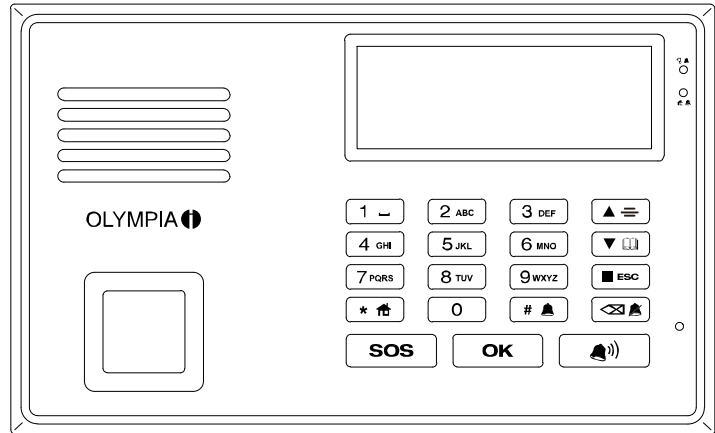

The emergency call number is dialled first, then up to 10 stored phone numbers in succession. A voice message requests the subscriber answering to press the **[1]** button on their phone.

The handsfree function is automatically activated on the base unit and enables communication between the caller and subscriber called.

Keys on the Base Unit



Button	Function
	SOS button: activate the GSM dialling unit
	Confirm input
	Panic button: trigger an acoustic alarm signal
	Open the menu; navigate in the menu; increase the loudspeaker volume in Hands-free mode

-  Open the save mode for phone numbers; navigate in the menu; reduce the loudspeaker volume in Handsfree mode
-  Disarmed mode: the system is deactivated; close the menu; stop the countdown
-  Silent mode: the system is armed; when the alarm is triggered, the GSM dialling unit is activated; deletes digits and letters
-  Alarm mode: the system is armed; on burglary, the acoustic alarm is issued and the dialling unit is activated
-  At Home mode: the system is activated; on burglary, the acoustic alarm is issued
- 0-9, *, #** Digit keys: on pressing the # button >3 sec., a 2 sec. dialling pause is activated
- *** In Text mode: switch between upper and lower case

#	à á â Ç
0, 1	Special characters
2	A B C 2 Ä Æ Å à á â ç a b c 2 ä æ å à á â ç
3	D E F 3 è É ê ë d e f 3 è é ê ë
4	G H I 4 ì í î ï g h i 4 ì í î ï
5	J K L 5 € j k l 5 €
6	M N O 6 ñ ò ó ô m n o 6 ñ ò ó ô
7	P Q R S 7 ß p q r s 7 ß
8	T U V 8 ù ú û Ü t u v 8 ù ú û ü
9	W X Y Z 9 w x y z 9

Operating Elements and Indicators

Display Icons

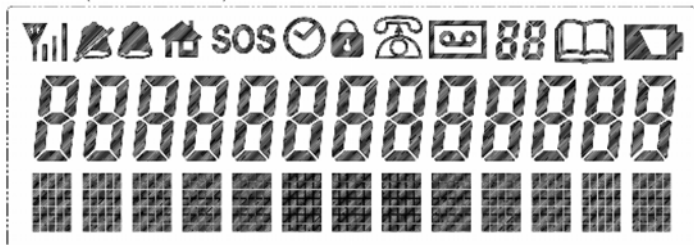

Symbol	Significance	Explanation
	Mobile network	<p>Full signal,</p> <p>Weak signal,</p> <p>No signal</p>
	Silent mode	When the alarm system is triggered, no acoustic alarm is issued; GSM dialling unit is active.

	Alarm mode	When the alarm system is triggered, an acoustic alarm is issued; GSM dialling unit is active.
	At Home mode	When the alarm system is triggered, an acoustic alarm is issued.
SOS	Emergency call	GSM dialling unit is active.
	Time delay	Time delay is activated.
	Key lock	Key lock is activated.
	GSM dialling unit	Connection is being made.
	Recording mode	Voice message is being recorded.
	Memory location	Indicates the memory location of the phone number.
	Save icon	
	Battery indicator	Battery capacity of base unit is low.



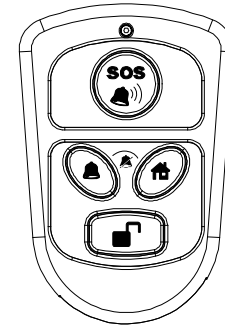

Overview of LEDs

	Operation via power adapter		Operation via battery	
	Top LED	Bottom LED	Top LED	Bottom LED
Silent mode	On	Flashes	On	Flashes
Alarm mode	Flashes	Off	Flashes	Off
At Home mode	On	On	Off	On
Disarmed mode	On	Off	Off	Off

Buttons on the Remote Control



Key Function

- 
Emergency call or panic function (can be configured on the base unit)
- 
Alarm mode: When the alarm system is triggered, an acoustic alarm is issued and the GSM dialling unit is activated
- 
At Home mode: When the alarm system is triggered, an acoustic alarm is issued
- 
Deactivate key lock on base unit; stop alarm; switch alarm system to disarmed
- 
Silent mode by pressing the Alarm and At Home mode buttons simultaneously

Menu Structure

Menu Structure







 (Open the menu)	Review	Open Sensor01 Remote:1	Voice Record Voice Record	
↓	Register	Search...	Open Sensor01 Remote:1	Voice Record Voice Record
↓	Trigger Delay	Duration Trigger Tone	Delay: 0-240S On Off	
↓	Arming Delay	Delay: 0-240S		
↓	Flood & Smoke	Standard Activate		
↓	PIR Home Mode	On Off		
↓	Remote Key	Remote: SOS Remote: PANIC		
↓	Entry Code	1234		

↓	Key Tone	Key Tone-On Key Tone-Off				
↓	KeyLock Delay	20S - 40S				
↓	Contrast	Contrast-1-5				
↓	Language**	LB1	LB2	LB3	LB4	LB5
		Deutsch	Deutsch	Deutsch	Deutsch	Deutsch
		English	English	English	English	English
		Français	Polski	Türkçe	Polski	česky
		Nederlands	Русский	česky	Slovenski	Slovenski
		Español	Română	Slowenský	Română	Română
		Português	Magyar	Dansk	Magyar	Polski
		Italiano	Ελληνικά	Svenska	Ελληνικά	Slowenský
↓	Date/Time	01-01-2010	00:00			
↓	Alarm period	Time:1-10Min				
↓	Check SIM \$	SIM Service #				

* The language range (LB 1 - LB 5) provided by your alarm system is indicated on the labels on the packaging and on the rear of the base unit.







Configuration

Navigating Through the Menu





- ➔ Press  to open the menu.
- ➔ Press  and  to navigate in the menu.
- ➔ Press  to confirm your entries.
- ➔ Press  to correct texts or numbers entered.
- ➔ Press  to move one level back in the menu.
- ➔ The key lock is automatically activated if there is no input for a period exceeding 10 seconds.

Language

There is a range of languages available for selection:

1. Enter your PIN. Confirm it by pressing .
2. Press  to open the menu.
3. Select the **Language** menu option.
Confirm it by pressing .
4. Select the language required by pressing the  and  buttons.
Confirm your selection by pressing .

Date and Time

1. Enter your PIN. Confirm it by pressing .
2. Press  to open the menu.
3. Select the **Date/Time** menu option.
Confirm it by pressing .
4. Display: **01-01-2010**
5. Enter the day, month and year.
Confirm it by pressing .
6. Display: **00:00**
7. Enter the time as hour and minute.
Confirm it by pressing .

PIN (Personal Identification Number)

The base unit is protected by a 4-digit PIN (Personal Identification Number) to prevent access to data by unauthorised third-parties.

The predefined PIN is active when the factory settings are set. The predefined PIN is provided in the battery compartment of the base unit and on the last page of this operating manual.

i For reasons of security, we recommend that you change the predefined PIN and enter your own personal PIN.

1. Enter the predefined PIN.
Confirm it by pressing **OK**.
2. Press **▲ ≡** to open the menu.
3. Select the **Entry Code** menu option. Confirm it by pressing **OK**. The predefined PIN appears in the display. The first digit flashes. Enter your own personal, 4-digit PIN. Confirm it by pressing **OK**.

i Note down your new PIN and keep it where it cannot be accessed by third-parties.

Key Lock

Before beginning to operate the base unit, deactivate the key lock function.

1. Enter your PIN.
Confirm it by pressing **OK**.

The key lock is reactivated automatically when no buttons are pressed for a period of 10 seconds.

You can also activate the key lock function manually by pressing the **1 ↵** button.

i The SOS and Panic buttons are excluded from the key lock function and are always functional!

Time for Automatic Key Lock

You can define the period of time which should elapse before the key lock is automatically activated when you do not operate the base unit.

You set a delay of between 20 and 40 seconds.

When the default setting is set, the key lock is activated after **20 seconds**.

1. Enter your PIN.
Confirm it by pressing **OK**.
2. Press **▲ ≡** to open the menu.
3. Select the **KeyLock Delay** menu option.
Confirm it by pressing **OK**.
4. Set the delay time **20S - 40S** using the **▲ ≡** and **▼** buttons. Confirm it by pressing **OK**.







Individual Outgoing Messages

i An individual outgoing message can be recorded for each sensor (door/window contact, smoke detector, etc.). The standard message is replaced by your individual voice message and played when the GSM dialling unit is activated!

Proceed as follows to record an individual messages for each respective sensor:

1. Enter your PIN.
Confirm it by pressing **OK**.
2. Press **▲ ≡** to open the menu.

Configuration

3. Select the **Review** menu option.
Confirm it by pressing .
 4. Select the respective sensor required by pressing the  and  buttons.
Confirm it by pressing .
 5. The first letter of the sensor selected flashes. You can rename the sensor (e.g. BalconyDoor, KitchenWindow,, etc.). Confirm it by pressing .
 6. **Voice Record** appears in the display.
Confirm it by pressing .
 7. Speak your individual voice message for the selected sensor into the unit (e.g. BalconyDoor).
Press the  button to confirm the message and end recording.
- ➔ Your individual message is played back.

GSM Dialling Unit

Function of the GSM Dialling Unit

The GSM dialling unit (quad band) establishes a connection between the Protect 9XXX Series alarm system and the mobile network.

It enables a telephone link to be set up without access to a landline.

A SIM card is required to operate the GSM dialling unit. This is not included in the equipment supplied.

i The alarm system can also be operated without a SIM card connection. However, in the event of an alarm, there is no alert via the mobile network!

If you use a SIM card, pay attention to the following:

- ➔ Check the contractual terms of your SIM card. Please note that, as a result of using a SIM card in the base unit, contract-related costs could ensue.
- ➔ The card must be topped up at regular intervals.
- ➔ Most prepaid SIM cards must be used at a charge within a certain period of time, otherwise they are blocked. More detailed information is available from your mobile phone provider.

Unlocking the SIM Card (Entering the SIM PIN)

SIM cards are normally protected against unauthorised access by a 4-digit PIN. When the SIM card is used for the first time, it must be unlocked.

1. If the SIM card is locked by means of a PIN, the **SIM Card PIN?** message appears in the display.
2. Enter the PIN which you received together with the SIM card.

➔ When the PIN entered is correct, **Search...** appears in the display.

The PIN is then permanently deactivated. If you insert the SIM card again or connect the base unit again, the PIN need not be re-entered.

3. When the PIN entered is incorrect, **Enter again** appears in the display. Enter the PIN again.

➔ If the PIN is entered incorrectly 3 times, **SIM Locked** appears in the display. In this case, contact your mobile phone provider to release the lock.

Checking the SIM Card

Check SIM \$ appears in the display on 1st January, 1st April, 1st July and 1st October.

1. Enter your PIN. Confirm it by pressing **OK**.
2. Press **▲☰** to open the menu.
3. Select the **Check SIM \$** menu option. Confirm it by pressing **OK**.
4. **SIM Service #** appears in the display.
5. Enter the service number of the mobile phone provider. Confirm it by pressing **OK**. The service number is dialled.
6. Follow the instructions from the mobile phone provider.
7. End the connection by pressing **OK**.

Preventing the SIM Card Bing Locked

Most prepaid SIM cards must be used at a charge within a certain period of time, otherwise they are blocked. You can use the function requesting the credit status to make a call liable for costs.

1. Enter your PIN. Confirm it by pressing **OK**.
2. Press **▲☰** to open the menu.
3. Select the **Check SIM \$** menu option. Confirm it by pressing **OK**.
4. **SIM Service #** appears in the display.

Configuration

5. Enter the number of your conventional phone or mobile phone. Confirm it by pressing **OK**. The number is dialled.
6. Take the call on your conventional phone or mobile phone.
7. End the connection by pressing **OK**.

Activating the GSM Dialling Unit

You can store up to 10 phone numbers or mobile phone numbers of contact persons. Agree on procedures in the event of an alarm with these contact persons.

In the event of an alarm, the GSM dialling unit automatically dials the phone numbers stored in succession (starting with memory location 0) and provides information regarding the alarm by means of an automatic voice message.

In the case of an "engaged" signal or no connection is possible, the next phone number is automatically dialled.

A total of three dialling cycles are completed!

The GMS dialling unit is deactivated when a subscriber called answers the call made and presses the digit key **[1]** on their telephone or 3 dialling cycles have been completed.

Saving Phone Numbers

Save the phone numbers of your contact person in the memory locations 0 - 9 (assigned to keys **0** to **9** wxyz).

Each phone number can be composed of up to 20 digits and the associated name up to 13 characters.







i Do not save any public emergency call numbers! Unjustified requests for police, fire and rescue services are liable for costs!

1. Enter your PIN. Confirm it by pressing **OK**.
2. Press **▼** **☰**. **Location Key** appears in the display.
3. Select a memory location. If you have not yet stored a phone number, **Empty** appears as information in the display. Confirm it by pressing **OK**.
4. Enter the phone number including the access code. Confirm it by pressing **OK**.
5. Enter the name associated with the phone number. Confirm it by pressing **OK**.

SOS (Emergency Call) Numbers



You can save an SOS (emergency call) number which is subsequently called first by pressing the **SOS** button or, depending on the configuration, the **SOS** button on the Remote control.



Following this, the other stored phone numbers are dialled in succession.

- Do not save any public emergency call numbers!
i Unjustified requests for police, fire and rescue services are liable for costs!
1. Enter your PIN. Confirm it by pressing .
 2. Press . **Location Key** appears in the display.
 3. Press the  button as the selected memory location. If you have not yet stored a phone number, **Empty** appears as information in the display.
Confirm it by pressing .
 4. Enter the phone number including the access code.
Confirm it by pressing .
 5. Enter the name associated with the phone number.
Confirm it by pressing .

Testing the GSM Dialling Unit

After having entered phone numbers, ensure that they are correct in respect of the alarm calls. For this purpose, you can trigger a silent alarm.

1. Enter your PIN. Confirm it by pressing .
2. Press . Silent mode is activated. Silent mode is indicated in the display by the  icon.
3. Now trigger the silent alarm on any of the door/window contacts (e.g. open door/window).

- The display lights up yellow and indicates which sensor has been triggered. The GSM dialling unit is activated.
- ➔ The subscriber called lifts the receiver and hears the individual outgoing message.
 - ➔ The subscriber called is also requested to press digit key **[1]** on their telephone. The screening function is activated. This function enables the subscriber to screen the room in which the base unit is located.
 - ➔ If the subscriber called does not initiate a function within 24 seconds, the next phone number is automatically dialled.
 - ➔ Silent mode is deactivated by pressing the  button on the remote control, entering your PIN on the base unit and confirming by pressing the  button or when the subscriber called ends the call.

Trigger Delay











You can define that the alarm to be triggered should be actually sounded after a delay.

This provides you with sufficient time to enter your apartment or house and disarm the alarm system.

You can set a trigger delay between 0 and 240 seconds.

If one of the sensors is tripped, the system must be switched to be disarmed for this period so that no alarm is triggered.

You can select whether an acoustic signal should be issued from the base unit during this period or not.

1. Enter your PIN. Confirm it by pressing .
2. Press  to open the menu.
3. Select the **Trigger Delay** menu option. Confirm it by pressing .
4. Select the **Duration** menu option. Confirm it by pressing .
5. Use the  and  buttons to set the required delay time.
6. Confirm it by pressing the  button.
7. Select the **Trigger Tone** menu option. Confirm it by pressing .
8. Set the trigger delay tone with the  and  buttons and switch it **Off** or **On**. Confirm it by pressing the  button.







Arming Delay

You can set the alarm system to be armed following a defined delay.

This provides you with sufficient time to leave your apartment or house through the alarm-protected front door before the alarm system is actually armed.

You can set an activation delay between 0 and 240 seconds.



During the delay period, you will hear a signal tone issued at intervals of one second.



1. Enter your PIN. Confirm it by pressing .
2. Press  to open the menu.
3. Select the **Arming Delay** menu option. Confirm it by pressing .
4. Use the  and  buttons to set the required delay time. Confirm it by pressing .

Alarm Period

The base unit is equipped with an integrated siren.







The duration of the acoustic alarm can be selected between a minimum of 1 minute to a maximum of 10 minutes. The standard setting for the alarm period is 3 minutes.

1. Enter your PIN. Confirm it by pressing .
2. Press  to open the menu.
3. Select the **Alarm period** menu option. Confirm it by pressing .

- Observe any locally applicable regulations regarding limitation of alarm times from burglar alarms.
4. Use the  and  buttons to set the required alarm time. Confirm it by pressing .







Key Tone

It is possible to switch the key tone feature for the base unit on and off.

1. Enter your PIN. Confirm it by pressing .
2. Press  to open the menu.
3. Select the **Key Tone** menu option. Confirm it by pressing .
4. Press  and  to switch the **Key Tone-On** or **Key Tone-Off**. Confirm it by pressing .

Display Contrast

The display contrast can be adjusted to one of five different settings.





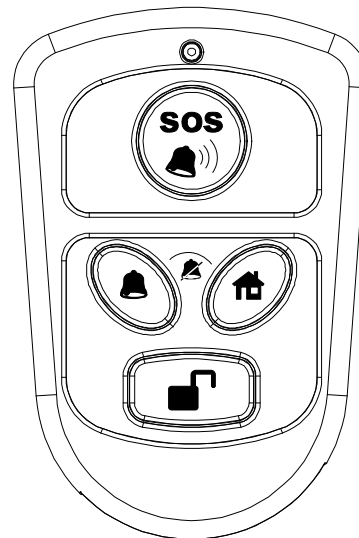

1. Enter your PIN. Confirm it by pressing .
2. Press  to open the menu.
3. Select the **Contrast** menu option. Confirm it by pressing .
4. Press the  and  buttons to set the required contrast setting. Confirm it by pressing .

Remote Control









Configuration

The  button on the remote control can be configured as an Emergency Call or Panic button via the base unit.

1. Enter your PIN. Confirm it by pressing .
2. Press  to open the menu.
3. Select the **Remote Key** menu option. Confirm it by pressing .
4. Use the  and  buttons to select the **Remote: SOS** or **Remote: PANIC** function. Confirm it by pressing .

Water Leak (Flood) and Smoke Detectors

You can set-up the base unit so that flood and smoke detectors trigger an alarm when the base unit is disarmed.

1. Enter your PIN. Confirm it by pressing .
2. Press  to open the menu.
3. Select the **Flood & Smoke** menu option. Confirm it by pressing .
4. Use the  and  buttons to select the **Standard** or **Activate** setting. Confirm it by pressing .





The table below indicates how the flood and smoke detectors are triggered according to the various settings.



	Standard		Activate	
	Phone call	Alarm signal	Phone call	Alarm signal
Disarmed mode	No	No	Yes	Yes
At Home mode	No	Yes	No	Yes
Silent mode	Yes	No	Yes	Yes
Alarm mode	Yes	Yes	Yes	Yes

Registering Sensors







You can register up to 32 sensors on the alarm system base unit.

If you purchase optionally available sensors, such as additional remote controls, smoke detectors etc., they must be registered manually.

1. Enter your PIN. Confirm it by pressing .
2. Press  to open the menu. Use the  and  buttons to select the **Register** menu option. Confirm it by pressing .
3. **Search...** appears in the display
4. Activate the sensor to be registered.

- More detailed information is provided in the operating manual supplied with the respective sensor.
5. **Open Sensor01** or **SmokeSensor01** appears in the display, for example. Confirm it by pressing .
 6. **Voice Record** appears in the display.
 7. Press the  button if you want to retain the standard message
or
 8. Press  to record an individual outgoing message.
- ➔ Your individual message is played back.

Deregistering Sensors

1. Enter your PIN. Confirm it by pressing .
2. Press the  button.
Review appears in the display.
3. Press the buttons  and  to select the sensor to be deregistered.
4. Press the  button.
Delete? appears in the display.
Confirm it by pressing .

Resetting the Factory Settings (RESET)

- Please note that on restoring the factory settings, all the user settings will be deleted. The registration of the sensors is retained!
 - When you have reset the factory settings on the base unit, the 4-digit PIN is **1-2-3-4!**
1. Use a screwdriver to loosen the screw in the battery and connection socket compartment on the underside of the base unit.
 2. Press the RESET button. The alarm system acknowledges a RESET by means of an acoustic signal.
 3. Close the battery and connection socket compartment and tighten the screw.

Monitoring Functions

Monitoring functions	Acoustic alarm signal	GSM dialling unit active
Silent mode	No	Yes, with screening function
Alarm mode	Yes	Yes
At Home mode	Yes	No
Disarmed mode	No	No
Emergency call (SOS)	No	Yes, with handsfree function
Panic alarm	Yes	No

Switching the Monitoring Functions On/Off

i Before switching any functions on, inform all the other people living in the residence regarding the location and method of operation of the wireless alarm system.

The alarm system distinguishes between 4 types of alarm:

➔ **📞 Alarm mode**

When Alarm mode is active and an alarm is triggered, an acoustic alarm signal is issued and the dialling unit is activated.

➔ **🏠 At Home mode**

When At Home mode is active and an alarm is triggered, only an acoustic alarm signal is issued.

➔ **🔇 Silent mode**

When Silent mode is active and an alarm is triggered, only the GSM dialling unit is activated. A person called receives a voice message requesting them to press the **[1]** button on their phone. The screening function is activated.

➔ **🛑 Disarmed mode**

When Disarmed mode is set, the alarm system is deactivated.

The monitoring functions are confirmed by a voice message.

i When triggered, the smoke detector always issues an acoustic alarm signal (immediately) regardless of the wireless alarm system! The response of the base unit

depends on the type of alarm set and the setting defined in the **Flood & Smoke** menu option.

- i** If an outdoor siren is registered on the base unit, the alarm can only be stopped by the remote control unit after 15 seconds at the soonest.

Alarm Mode

You should activate Alarm mode when you leave your apartment or house. Before doing so, check that all the doors and windows provided with a door/window contact are closed.

You can activate the required alarm type on the base unit or via the remote control supplied as follows:

Base Unit

1. Enter your PIN. Confirm it by pressing **OK**.
2. Press the **#** button.

Remote Control

1. Press the **⏪** button.

At Home Mode

During the night, before you go to sleep, you should activate At Home mode. Before doing so, check that all the doors and windows are closed.

You can activate the required alarm type on the base unit or via the remote control supplied as follows.

Base Unit

1. Enter your PIN. Confirm it by pressing **OK**.
2. Press the *** Home** button.

Remote Control

1. Press the **⏪** button.

PIR At Home Mode

Using the optional PIR At Home mode, the alarm caused by the motion detectors in At Home mode is deactivated. This mode can only be activated on the base unit.

- i** When PIR At Home mode is activated, the motion detectors registered on the base unit are deactivated in At Home mode. This means that false alarms caused by unavoidable movements within the area monitored (by residents, pets, etc.) can be prevented.

1. Enter your PIN. Confirm it by pressing **OK**.
2. Press **▲ ≡** to open the menu.
3. Select the **PIR Home Mode** menu option. Confirm it by pressing **OK**.
4. Use the **▲ ≡** and **▼** buttons to switch the function **On** or **Off**. Confirm it by pressing **OK**.



Monitoring Functions

Silent Mode

When you leave your apartment or house, you can activate Silent mode instead of Alarm mode. Before doing so, check that all the doors and windows provided with a door/window contact are closed.

You can activate the required alarm mode on the base unit or via the remote control supplied as follows.

Base Unit

1. Enter your PIN. Confirm it by pressing .
- ➔ Press the  button.

Remote Control

1. Press the  and  buttons simultaneously.

Disarmed Mode

When the system is disarmed, you can move freely within the living quarters without triggering any alarms.

You can activate the required alarm mode on the base unit or via the remote control supplied as follows.



Base Unit

1. Enter your PIN.
Confirm it by pressing .

Remote Control

1. Press the  button.



Panic Alarm

You can activate a panic alarm as a deterrent by pressing the  button on the base unit or the  button on the remote control unit, depending on the configuration.



CAUTION!

- Hearing damage through loud alarm signal!
- ➔ Due to legal requirements, the alarm signal continues for maximally 120 seconds. The alarm signal switches off automatically after approx. 120 seconds if the user does not interrupt it.
- ➔ Use ear protectors when testing the device.
- ➔ Do not remain in the vicinity of the acoustic alarm for a longer period when it has been triggered.

The panic alarm is triggered immediately without any delay. To switch off the panic alarm, enter your 4-digit PIN on the base unit. Confirm it by pressing . Or, you can press the  button on the remote control.

Emergency Call (SOS)

You can trigger the SOS (emergency call) function by pressing the **SOS** button on the base unit or the **SOS** button on the remote control unit, depending on the configuration.

The GSM dialling unit is activated when phone numbers are stored. The emergency call number is dialled first, then up to 10 stored phone numbers in succession. A voice message requests the subscriber answering to press the **[1]** button on their phone.

The handsfree function of the base unit is activated and enables communication between the caller and subscriber called.

There are three ways to end the SOS function:

- ➔ Enter your 4-digit PIN on the base unit and confirm it by pressing the **OK** button.
 - ➔ Press the **lock** button on the remote control.
- or
- ➔ The subscriber called takes the call, executes a function within 24 seconds and then ends the call.

Remote Access Via Telephone

The wireless alarm system can be operated by remote access using a telephone.

1. Dial the mobile phone number of the SIM card installed in the alarm system.
2. Wait until the alarm system takes your call. A longer acoustic signal is issued.
3. Enter the **4-digit PIN of the base unit**. Two short acoustic tones are issued.
4. Complete various functions using the phone's keypad (refer to the table). The monitoring functions are confirmed by a voice message.

Key	Function
[1]	Activate the handsfree function
[2]	Activate call screening
[3]	Activate Alarm mode
[4]	Activate At Home mode
[5]	Activate Silent mode
[6]	Activate Disarmed mode
[#]	End the handsfree or screening function
[#], [#]	End remote access via telephone facility

Appendix

System Extension

You can order accessories and options for the wireless alarm system via the following website

www.olympia-vertrieb.de



Products



Security products



Wireless alarm systems

Changing the Batteries

If the battery charge of the sensors is low or practically empty, the following status messages appear in the display:

Battery Capacity Low

1. **bAtt Lo** appears in the display. The sensor affected is displayed.
 - ➔ If you activate the alarm system, 5 successive, short acoustic signals are issued.
 - **i** Change the batteries! A connection between the sensor and base unit is no longer guaranteed!

Battery Capacity Exhausted

1. **bAtt off** appears in the display. The sensor affected is displayed.
 - ➔ If you activate the alarm system, 5 successive, short acoustic signals are issued.
 - **i** Change the batteries! A connection between the sensor and base unit is no longer guaranteed!

Remote Control

ATTENTION!

- Property damage through the use of inappropriate batteries!
- ➔ The use of inappropriate batteries can cause a loss of function of the device.
- ➔ Only use batteries of the type described in Section **Technical Data**.

1. Use a suitable screwdriver to loosen the screw in the battery compartment on the underside of the remote control.
2. Remove the cover of the battery compartment.
3. Remove the battery contained.
4. Insert a new battery in the battery compartment (pay attention to correct polarity).
5. Replace the cover on the battery compartment.
6. Replace and tighten the screw.

Base Unit

The use of batteries serves as a safeguard against failure. In the case of normal power supply using the power adapter plug, the batteries are not affected. In the event of

a power failure, the base unit is battery powered until the power supply is restored.

The  icon in the display indicates that the batteries in the base unit are almost fully discharged. Change the batteries.

ATTENTION!

- Property damage through the use of inappropriate batteries!
- ➔ The use of inappropriate batteries can cause a loss of function of the device.
- ➔ Only use batteries of the type described in Section **Technical Data**.

1. Use a screwdriver to loosen the screw in the battery and connection socket compartment on the underside of the base unit.
2. Remove the cover from the battery and connection socket compartment.
3. Remove the batteries contained.
4. Insert three new batteries in the battery compartment (pay attention to correct polarity).
5. Replace the lid on the battery and connection socket compartment.
6. Replace and tighten the screw.

Regular Maintenance and Service

Regular Maintenance and Service

- ➔ Disconnect the base unit from the power outlet before cleaning it!
- ➔ Clean the surface of the housing with a soft, lint-free cloth. Never use any chemicals or scouring agents.
- ➔ Complete a function test once a month and after changing the batteries.
- ➔ Change the batteries on an annual basis or when the corresponding message is issued by the alarm system at the latest.

Information on Disposal



The adjacent symbol indicates that **electrical and electronic apparatus and batteries** no longer required must be disposed of separate from domestic waste in accordance with legal directives.



You are obliged to dispose of **batteries and power packs** at shops which sell batteries or collection points which provide the corresponding containers. Disposal is free of charge. The symbols indicate that the batteries must not be disposed of in normal domestic waste and that they must be brought to collection points provided by local public waste authorities.

Packaging materials must be disposed of according to local regulations.

Technical Data

The wireless alarm systems in the Protect 9XXX Series operate within the frequency band specially reserved for security technology in the 868 MHz frequency range.

This ensures that interference to the alarm system through other consumer products, such as baby alarms, can be ruled out. However, it cannot be ruled out that the radio transmission suffers intermittent or continuous interference due to defective components of other electrical or electronic products, such as ventilators and antenna amplifiers. In addition, radio transmission can be interfered from external sources with malicious intent.

Main base

Weight	228 g (without batteries)
Dimensions	172 x 105 x 31 [mm]
Frequency	868 MHz
Battery	3 x alkaline, AAA
Power adapter plug	5 V _{DC} , 1.2 A
Sensors	Max. 32

Remote control

Weight	24 g
Dimensions	40 x 60 x 14.5 mm
Frequency	868 MHz
Battery	Lithium CR2430, 3 V

Technical Data

Technical Modifications

This instruction manual serves purely for information purposes. Its content is not part of any contract for sale.

All the data relates to nominal values. The equipment and options described may differ from country to country according to national requirements.

CE Mark



Olympia Business Systems Vertriebs GmbH, Zum Kraftwerk 1, 45527 Hattingen hereby declares that this device fulfils the requirements and complies with the regulations stipulated in the Directive 1999/5/EC. The CE Mark on the device confirms conformity. The Declaration of Conformity related to this product can be viewed on our website at www.olympia-vertrieb.de.

Newsletter

You can register on our website so that you are automatically informed in respect of extensions to the range of accessories and product updates.

Register now under: www.olympia-vertrieb.de.

Manufacturer

Olympia Business Systems Vertriebs GmbH
Zum Kraftwerk 1
45527 Hattingen
GERMANY







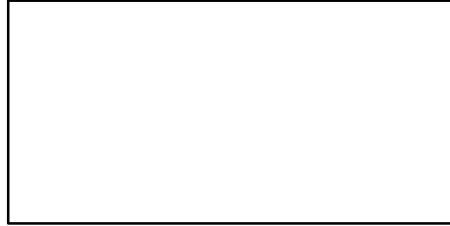

This is your individual, predefined PIN (Personal Identification Number)!

If you want to change this predefined PIN code, please refer to Chapter "Configuration" in this operating manual.

Keep this operating manual in a safe place away from the wireless alarm system!

Please note that the Copyright of this operating instruction manual is by Olympia and, therefore, must not be further copied, published or sold in any form. The information contained in the operating instruction manual is only intended for personal use.



All rights reserved.