

Build your own boombox

This amplifier kit with plug-in board and all necessary components is easy and quick to assemble, requires no soldering and is great fun. Listen to your favourite music with your own amplifier. Everyone can buy a finished product, but you can build your own amplifier according to your own particular requirements. Several circuit variants are depicted and explained. Special applications are also possible. In the end you will not only have a sense of achievement, but also experience in electronics.

We wish you lots of fun and success!

1. Quick start

For those who are already familiar with the components, this is where it all starts. Install the complete circuit and switch on the device. Then connect your audio source with the included stereo cable and enjoy the music!

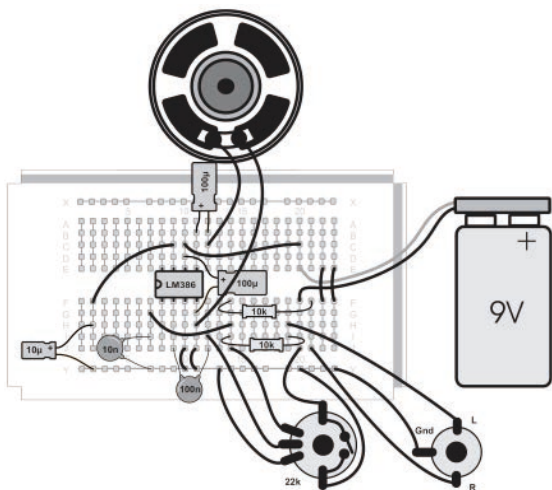

The complete circuit diagram shows all components from the stereo input jack to the loudspeaker. In some instances, there may be variations. For example, you can replace the resistors to adjust the volume. Dashed connections indicate that these components can be used optionally. Possible variants are presented in more detail below.

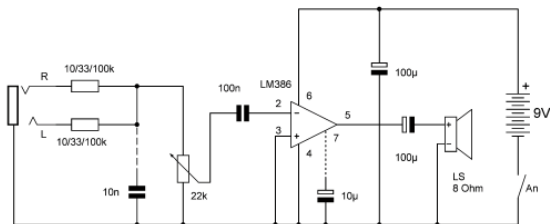

2. Assembly

The kit contains a potentiometer for adjusting the volume and a switch contact for switching off. Install the potentiometer and speaker in the housing. Secure the speaker with a drop of glue. Then stick the plug-in board between the potentiometer and the speaker. It has a double-sided adhesive film, which is covered with a protective film. First, determine the optimal position of the plug-in board. Remove the protective film and secure the plug-in board. Attention: The position must be correct on the first attempt as it is difficult to correct at a later stage. Finally, screw the stereo jack into the casing. All these components have soldered wires. Avoid bending these wires too often so they don't break off.

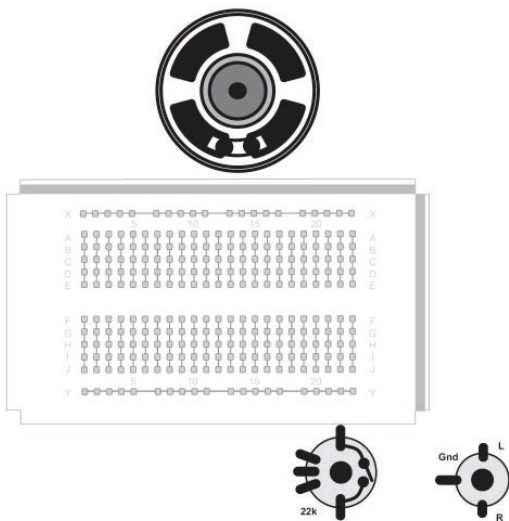

3. Circuit structure

The core of the kit is the integrated loudspeaker amplifier LM386, in an eight-prong casing. The eight prongs are initially spread a little and must be aligned in parallel. Only then the integrated circuit (IC) can be easily inserted into the plug-in

board. It is essential to pay attention to the correct installation direction in the circuit. A marker on the left side indicates pin 1 and pin 8. If you want to remove the IC, carefully remove it using a screwdriver, so that the connections do not kink.

To build the circuit, you need a few short wires. Use the insulated jumper wire for this. Use pliers to cut off suitable pieces and remove the insulation at the tips to a length of about 8 mm. For stripping the wire tips, cut the insulation around the tips using a sharp knife. Attention, be sure not to scratch the wire, otherwise it can break.

Test the circuit using a 9 V battery. To ensure safety while experimenting, use a normal zinc-carbon battery. Alkaline batteries are not ideal as they can emit a strong current in the event of a short circuit. Once everything has been tested successfully, the battery should be mounted in the housing using double-sided adhesive tape.

The first experiment shows that you only need a few components around the LM386 to build a complete amplifier. Pin 4 of the IC is located at the negative pole of the battery; the positive pole is connected to pin 6. The output is at pin 5. The speaker is connected here via an electrolytic capacitor with 100 μF . Pin 5 of the LM386 has an average output voltage of about 4 V. Therefore, the positive pole of the electrolytic capacitor must point to the IC, while the negative pole, marked by a white stripe, must point to the speaker.

The input is at pin 2 of the IC. A coupling capacitor with 100 nF (inscription 104) is connected here. Touch the free tip of the wire. You will hear a soft humming or buzzing noise coming from the speaker when you do this. It comes from the electrical wires and equipment in the room and is picked up, amplified and made audible by your body like an antenna. This simple humming test is useful when checking an amplifier and can be used later on the finished device for troubleshooting.

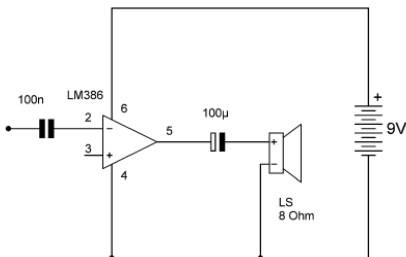

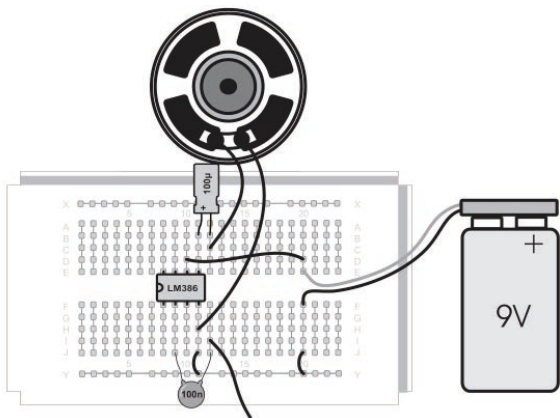

4. Volume control and switch

Now connect the volume control and the jack. Attention, only use two connecting wires of the stereo socket, GND and L. The R input must remain free. In fact, you will only use one of the two stereo channels, the second one will be added later. Make sure that the wires on the R and L terminals never touch, as this could overload your connected equipment.

Note the ground connection at pin 3 of the amplifier. The first experiment has shown that in principle the amplifier will work without the second input of pin 3, but it prevents distortion and improves the sound quality.

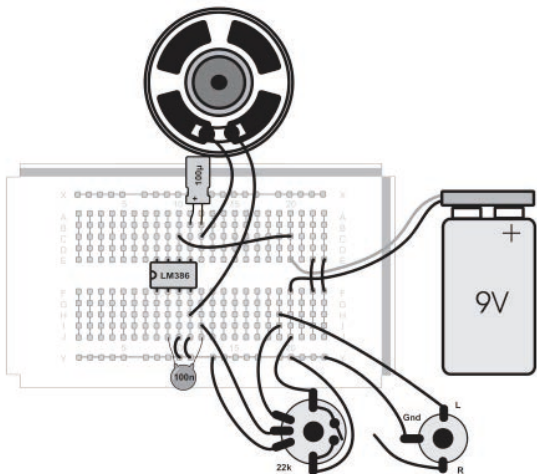

In the first experiment, the battery was connected directly, which is not very practical for daily use. Now you should install the switch on the potentiometer. In this case, in the negative line to keep the connections short. In addition, the battery cable should be fitted with a simple strain relief ring. Two short pieces of wire to hold the cable in place. This will prevent the battery cable from accidentally disconnecting.

The amplifier is probably still too sensitive in this circuit and can easily be overmodulated. An adjustment to the amplification is added later. For now, you should turn up the volume knob only a little. Too much modulation will result in strong distortions.

5. Stereo input

For the right sound, the right and left channels must be merged. For this, insert two resistors of $33\text{ k}\Omega$ (with ring colours: orange, orange, orange). This will also reduce the amplification of the device. The right modulation depends on the connected device.

A further improvement can be achieved with a second $100\text{ }\mu\text{F}$ electrolytic capacitor connected in parallel to the power supply. Make sure the polarity is correct. The white bar marks the negative terminal of the electrolytic capacitor.

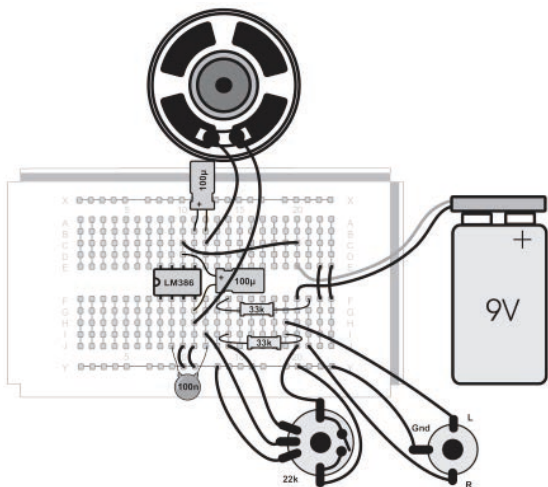
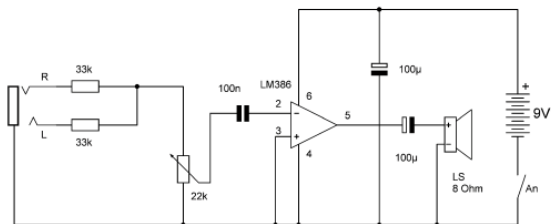

6. Adjustments

Different results will be produced depending on the connected device, be it an MP3 player, a smartphone or other device. In one case, the amplifier may be too soft, in another case it may tend to overmodulate. For this reason, the kit comes with different resistors. Test all three variations and find the best setting for your purpose:

10 k Ω (brown, black, orange): Loud

33 k Ω (orange, orange, orange): Middle

100 k Ω (brown, black, yellow): Soft

Parallel to the potentiometer is an optional capacitor with 10 nF (label 103). This allows you to change the sound. With inserted condenser you get a slight reduction of the high frequencies. This can improve the sound because the relatively small speaker tends to overemphasise the high frequencies. Incidentally, the sound can also be influenced by the casing, which is more or less closed. Test the amplifier with the housing open, closed and partially closed, with and without the additional 10 nF capacitor. Find the best setting for you. Another 10 μ F electrolytic capacitor should be connected to pin 7 of the LM386. In most instances, this does not affect the sound. However, the capacitor prevents distortion and noise that may occur with a low battery or when using an external power supply. There are no disadvantages, so it's a good idea to leave the capacitor installed.

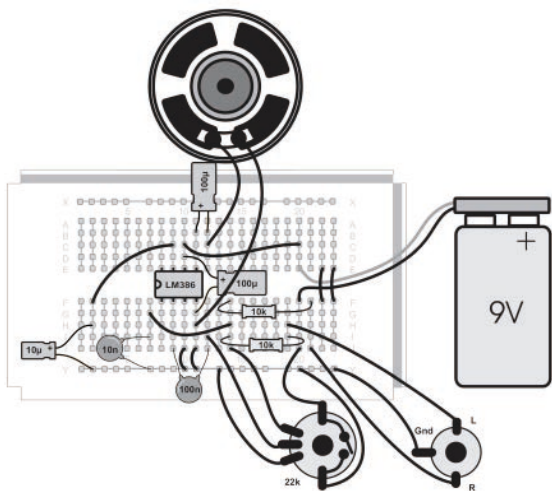
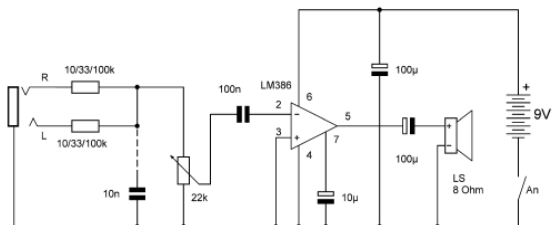

7. More amplification

The amplification is sufficient for connecting to MP3 players or smartphones. You can also do other things with the device, such as connecting a microphone or other low-level signal source. In such cases, it may be useful to increase the amplification once more by a factor of 10. To do this, connect the 10 μF electrolytic capacitor between pin 1 and pin 8. The input resistors are also omitted in this circuit, which means you need to connect a pure mono source.

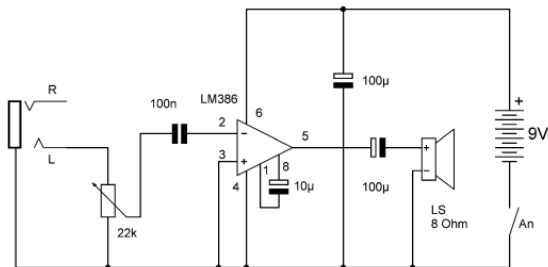

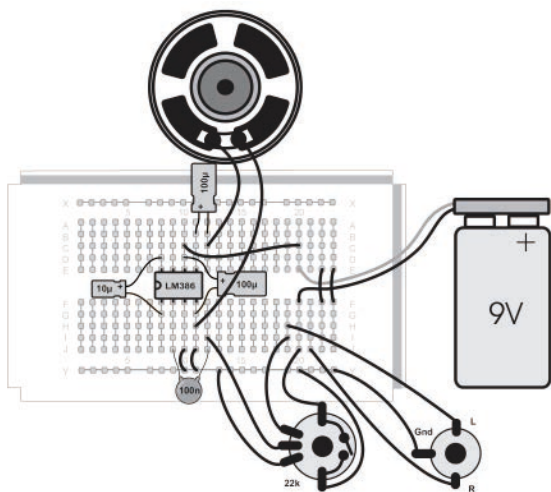

8. Circuitry

If you want to understand the amplifier properly, take a look at the data sheet. The internal circuit shows a push-pull amplifier with a differential preamplifier. Both output transistors form the push-pull output stage, with only one of the two transistors being employed at high modulation. Without modulation, only a small quiescent current will flow, which saves the battery. The optional bypass capacitor on pin 7 smoothes the operating voltage for the pre-stage.

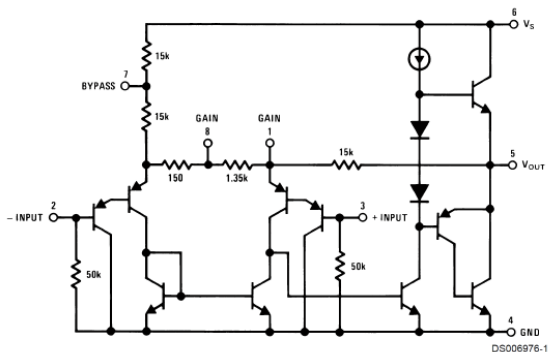

(Source: National Semiconductor)

In the input stage, two PNP-Darlington pairs operate in a differential stage. The average input voltage is zero; the input resistance is $50\text{ k}\Omega$. You will see that an input can remain open. The voltage amplification results from the negative feedback of twice $15\text{ k}\Omega$ from the output in proportion to $1.5\text{ k}\Omega$ between the emitters of the input stage and is 20 times (26 dB). If you bridge the connections 1 and 8 with a capacitor, it will result in another factor 10 ($1.5\text{ k}\Omega/150\text{ }\Omega$). The amplification is then 200 times (46 dB).

Imprint:

All circuits and programmes presented in this book have been developed, tried and tested with the utmost care. However, errors cannot be completely excluded. The publisher and author are liable in cases of intent or gross negligence in accordance with statutory provisions. Moreover, the publisher and author shall only be held liable under the Product Liability Act for injury of life, body or health or for a culpable violation of essential contractual obligations. However, the claim for damages for the infringement of essential contractual obligations shall be limited to foreseeable contract-specific damages, unless a case of mandatory liability in terms of the Product Liability Act 2 exists.

Attention! Eye protection and LEDs: Do not look directly into an LED from a short distance, as it can cause retinal damage! This is especially true for bright LEDs in clear housing and especially for power LEDs. With white, blue, violet and ultraviolet LEDs, the apparent brightness gives a false sense of the actual danger to your eyes. Take special care when using conical lenses. Operate the LEDs as intended in the manual, and do not use higher voltages.

Dear Customers,

This product has been manufactured in accordance with the applicable European directives and therefore bears the CE mark. The intended use is described in the enclosed instructions. For any other use or modification of the product, you are responsible to comply with applicable rules. Therefore, install the circuits exactly as described in the instructions. The product may only be distributed along with this manual.



The symbol of the crossed-out wheelie bin means that this product must be sent for recycling separately from household waste as electronic waste. Consult with your local authority to find the nearest free collection point.



© 2018 Franzis Verlag GmbH, Richard-Reitzner-Allee 2, 85540 Haar bei München
Author: Burkhard Kainka

All rights reserved, including those of photomechanical reproduction and storage in electronic media. The production and distribution of copies on paper, on data media or on the Internet, in particular as PDF, is permitted only with the express permission of the publisher and will otherwise lead to prosecution. Most product designations of hardware and software as well as company names and logos mentioned in this work are usually also registered trademarks and should be considered as such. The publisher essentially follows the spellings of the manufacturers in terms of the product names.

Produced on behalf of Conrad Electronic SE, Klaus-Conrad-Str. 1, 92240 Hirschau
art & design: www.ideehoch2.de
GTIN 4019631150394