

Capacitor contactor, AC-6b 25 kVA_r, / 400 V 1 NO + 2 NC, 24 V AC, 50 Hz 3-pole, Size S0 screw terminal



| | |
|---|---------------------------|
| Product brand name | SIRIUS |
| Product designation | capacitor contactors |
| Product type designation | 3RT26 |
| General technical data | |
| Size of contactor | S0 |
| Product extension | |
| • Auxiliary switch | No |
| Surge voltage resistance | |
| • of main circuit rated value | 6 kV |
| • of auxiliary circuit rated value | 6 kV |
| maximum permissible voltage for safe isolation | |
| • between coil and main contacts acc. to EN 60947-1 | 400 V |
| Protection class IP | |
| • on the front | IP20 |
| • of the terminal | IP20 |
| Shock resistance at rectangular impulse | |
| • at AC | 8,3g / 5 ms, 5,3g / 10 ms |
| Shock resistance with sine pulse | |

| | |
|--|----------------------------|
| <ul style="list-style-type: none"> • at AC | 13,5g / 5 ms, 8,3g / 10 ms |
| Mechanical service life (switching cycles) | |
| <ul style="list-style-type: none"> • of the contactor with added auxiliary switch block typical | 3 000 000 |
| Electrical endurance (switching cycles) | 200 000 |
| Reference code acc. to DIN EN 81346-2 | Q |

| Ambient conditions | |
|--|----------------|
| Installation altitude at height above sea level | |
| <ul style="list-style-type: none"> • maximum | 2 000 m |
| Ambient temperature | |
| <ul style="list-style-type: none"> • during operation | -25 ... +60 °C |
| <ul style="list-style-type: none"> • during storage | -55 ... +80 °C |

| Main circuit | |
|---|----------------|
| Number of NO contacts for main contacts | 3 |
| Number of NC contacts for main contacts | 0 |
| Operating current | |
| <ul style="list-style-type: none"> • at AC-6b at 690 V at ambient temperature 60 °C rated value | 36 A |
| Operational reactive power at AC-6b | |
| <ul style="list-style-type: none"> • at 230 V at 50/60 Hz at ambient temperature 60 °C rated value | 5 ... 14 kvar |
| <ul style="list-style-type: none"> • at 400 V at 50/60 Hz at ambient temperature 60 °C rated value | 8 ... 25 kvar |
| <ul style="list-style-type: none"> • at 500 V at 50/60 Hz at ambient temperature 60 °C rated value | 10 ... 31 kvar |
| <ul style="list-style-type: none"> • at 690 V at 50/60 Hz at ambient temperature 60 °C rated value | 14 ... 43 kvar |
| No-load switching frequency | |
| <ul style="list-style-type: none"> • at AC | 500 1/h |
| Operating frequency at AC-6b | |
| <ul style="list-style-type: none"> • at 230 V maximum | 100 1/h |
| <ul style="list-style-type: none"> • at 240 V maximum | 100 1/h |
| <ul style="list-style-type: none"> • at 400 V maximum | 100 1/h |
| <ul style="list-style-type: none"> • at 480 V maximum | 100 1/h |
| <ul style="list-style-type: none"> • at 500 V maximum | 100 1/h |
| <ul style="list-style-type: none"> • at 600 V maximum | 100 1/h |
| <ul style="list-style-type: none"> • at 690 V maximum | 72 1/h |

| Control circuit/ Control | |
|--|------|
| Type of voltage | AC |
| Type of voltage of the control supply voltage | AC |
| Control supply voltage at AC | |
| <ul style="list-style-type: none"> • at 50 Hz rated value | 24 V |

| | |
|--|--------------|
| Control supply voltage frequency • 1 rated value | 50 Hz |
| Operating range factor control supply voltage rated value of magnet coil at AC • at 50 Hz | 0.8 ... 1.1 |
| Apparent pick-up power of magnet coil at AC | 77 V·A |
| Inductive power factor with closing power of the coil | 0.82 |
| Apparent holding power of magnet coil at AC | 9.8 V·A |
| Inductive power factor with the holding power of the coil | 0.25 |
| Closing delay • at AC | 8 ... 40 ms |
| Arcing time | 10 ... 15 ms |
| Residual current of the electronics for control with signal <0> • at AC at 230 V maximum permissible | 7 mA |

Auxiliary circuit

| | |
|---|-------------------------------------|
| Number of NC contacts for auxiliary contacts • attachable • instantaneous contact | 2 0 2 |
| Number of NO contacts for auxiliary contacts • attachable • instantaneous contact | 1 0 1 |
| Operating current of auxiliary contacts at AC-12 maximum | 10 A |
| Operating current of auxiliary contacts at AC-15 • at 230 V • at 400 V | 6 A 3 A |
| Operating current of auxiliary contacts at DC-13 • at 24 V • at 60 V • at 110 V • at 125 V • at 220 V | 6 A 2 A 1 A 0.9 A 0.3 A |
| Contact reliability of auxiliary contacts | 0.00000001 |

UL/CSA ratings

| | |
|---|-------------|
| Contact rating of auxiliary contacts according to UL | A600 / Q600 |
|---|-------------|

Short-circuit protection

| | |
|--|-------------------------|
| Design of the fuse link • for short-circuit protection of the main circuit — with type of coordination 1 required | gG: 80 A (690 V, 50 kA) |
|--|-------------------------|

- for short-circuit protection of the auxiliary switch required

gG: 10 A (500 V, 1 kA)

Installation/ mounting/ dimensions

| | |
|---|--|
| Mounting position | +/-180° rotation possible on vertical mounting surface; can be tilted forward and backward by +/- 22.5° on vertical mounting surface |
| Mounting type | screw and snap-on mounting onto 35 mm standard mounting rail according to DIN EN 50022 |
| Height | 135 mm |
| Width | 45 mm |
| Depth | 155 mm |
| Required spacing | |
| <ul style="list-style-type: none"> • with side-by-side mounting <ul style="list-style-type: none"> — at the side | 10 mm |
| <ul style="list-style-type: none"> • for grounded parts <ul style="list-style-type: none"> — at the side | 10 mm |

Connections/ Terminals

| | |
|---|---|
| Type of electrical connection | |
| <ul style="list-style-type: none"> • for main current circuit | screw-type terminals |
| <ul style="list-style-type: none"> • for auxiliary and control current circuit | screw-type terminals |
| Type of connectable conductor cross-sections | |
| <ul style="list-style-type: none"> • for main contacts <ul style="list-style-type: none"> — solid — stranded — single or multi-stranded — finely stranded with core end processing • at AWG conductors for main contacts | 2x (1 ... 2.5 mm ²), 2x (2.5 ... 10 mm ²) 2x (1 ... 2.5 mm ²), 2x (2.5 ... 10 mm ²) 2x (1 ... 2,5 mm ²), 2x (2,5 ... 10 mm ²) 2x (1 ... 2.5 mm ²), 2x (2.5 ... 6 mm ²), 1x 10 mm ² 2x (16 ... 12), 2x (14 ... 8) |
| Type of connectable conductor cross-sections | |
| <ul style="list-style-type: none"> • for auxiliary contacts <ul style="list-style-type: none"> — solid — single or multi-stranded — finely stranded with core end processing • at AWG conductors for auxiliary contacts | 2x (0.5 ... 1.5 mm ²), 2x (0.75 ... 2.5 mm ²), 2x 4 mm ² 2x (0,5 ... 1,5 mm ²), 2x (0,75 ... 2,5 mm ²), 2x 4 mm ² 2x (0.5 ... 1.5 mm ²), 2x (0.75 ... 2.5 mm ²) 2x (20 ... 16), 2x (18 ... 14), 2x 12 |
| Type of minimum connectable cross-section for main contacts at AC-6b | |
| <ul style="list-style-type: none"> • at 40 °C • at 60 °C | 1x 10 mm ² 2x 10 mm ² |
| AWG number as coded connectable conductor cross section for main contacts | 16 ... 8 |

Safety related data

| | |
|--|----|
| Product function | |
| <ul style="list-style-type: none"> • Mirror contact acc. to IEC 60947-4-1 | No |









- positively driven operation acc. to IEC 60947-5-1

No

Protection against electrical shock

finger-safe

Certificates/ approvals

| General Product Approval | | | EMC | Declaration of Conformity |
|--|--|---|---|--|
|  CCC |  CSA |  UL |  |  RCM |
| | | | |  EG-Konf. |
| Declaration of Conformity | Test Certificates | Marine / Shipping | other | |
| Miscellaneous | Type Test Certificates/Test Report |  BUREAU VERITAS |  RMRS | Confirmation  VDE |

Further information

Information- and Downloadcenter (Catalogs, Brochures,...)

www.siemens.com/sirius/catalogs

Industry Mall (Online ordering system)

<https://mall.industry.siemens.com/mall/en/en/Catalog/product?mlfb=3RT2627-1AB05>

Cax online generator

<http://support.automation.siemens.com/WW/CAXorder/default.aspx?lang=en&mlfb=3RT2627-1AB05>

Service&Support (Manuals, Certificates, Characteristics, FAQs,...)

<https://support.industry.siemens.com/cs/ww/en/ps/3RT2627-1AB05>

Image database (product images, 2D dimension drawings, 3D models, device circuit diagrams, EPLAN macros, ...)

http://www.automation.siemens.com/bilddb/cax_de.aspx?mlfb=3RT2627-1AB05&lang=en

Characteristic: Tripping characteristics, I²t, Let-through current

<https://support.industry.siemens.com/cs/ww/en/ps/3RT2627-1AB05/char>

Further characteristics (e.g. electrical endurance, switching frequency)

<http://www.automation.siemens.com/bilddb/index.aspx?view=Search&mlfb=3RT2627-1AB05&objecttype=14&gridview=view1>

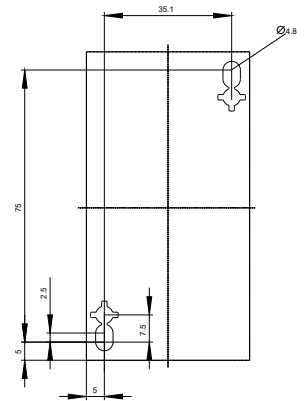
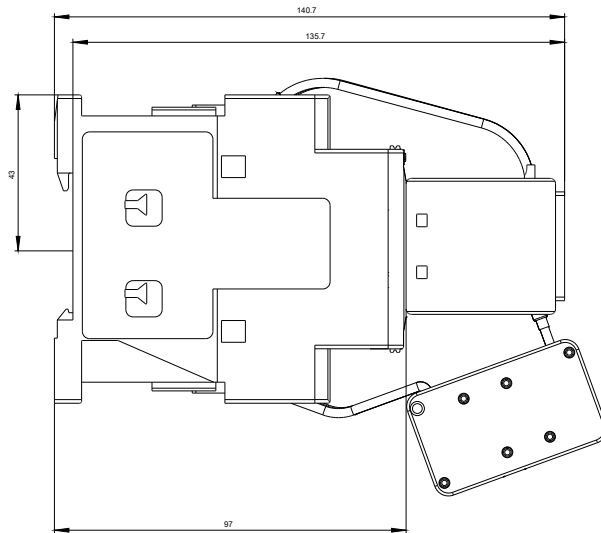
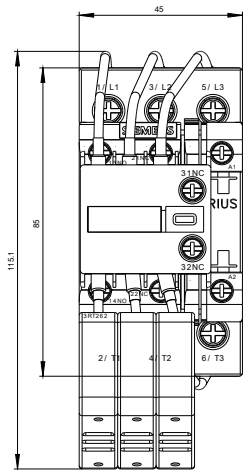

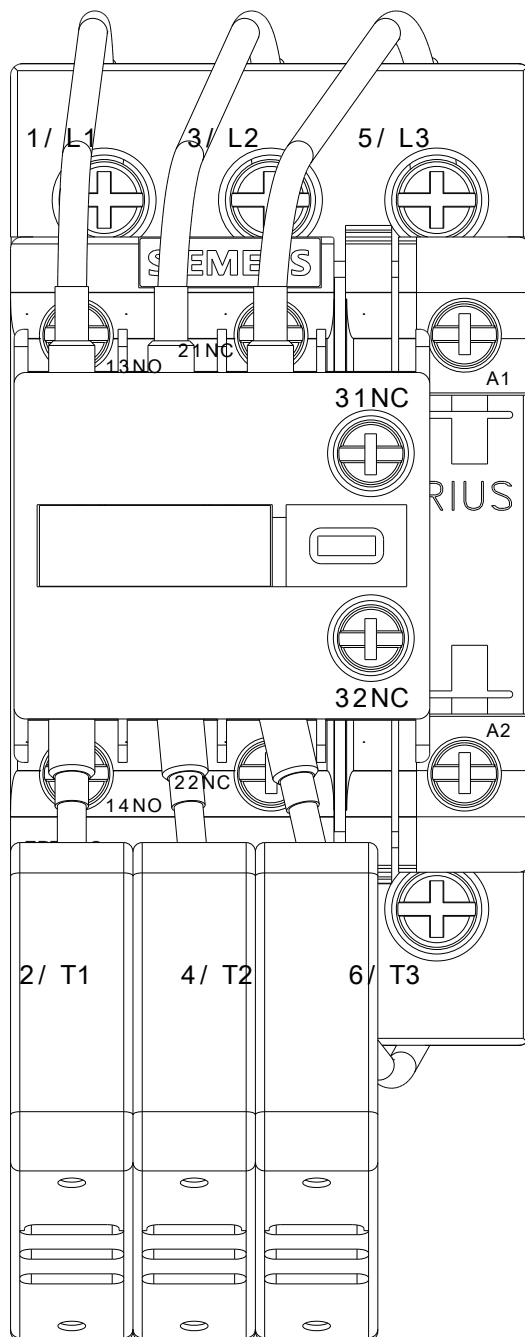

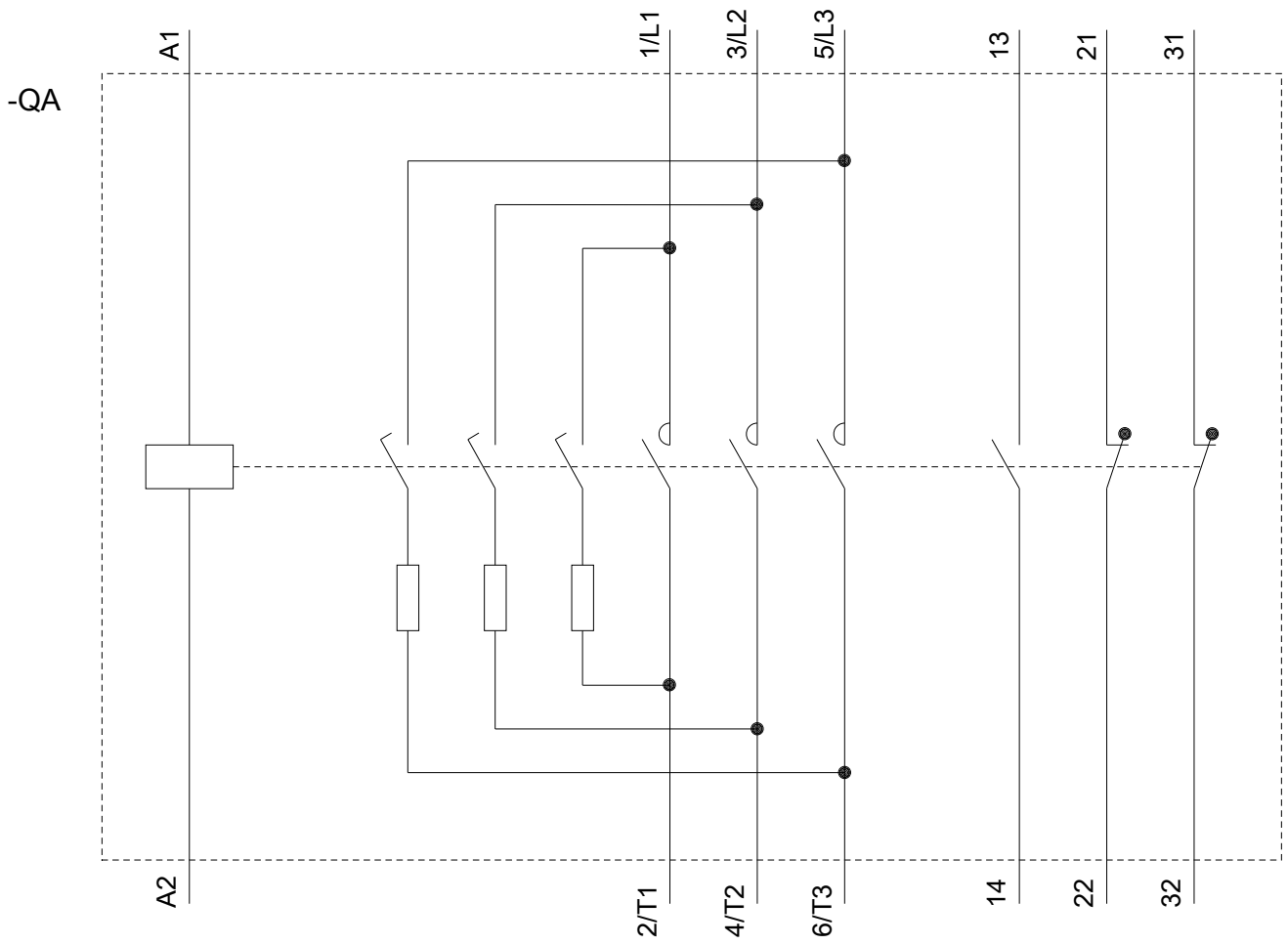

last modified:

09/04/2019