

Capacitor contactor, AC-6b 33 kVAr, / 400 V 1 NO + 2 NC, 50-60 Hz
AC 21-28 V DC 3-pole, Size S0 screw terminal



Product brand name	SIRIUS
Product designation	capacitor contactors
Product type designation	3RT26

General technical data	
Size of contactor	S0
Product extension	
• Auxiliary switch	No
Surge voltage resistance	
• of main circuit rated value	6 kV
• of auxiliary circuit rated value	6 kV
maximum permissible voltage for safe isolation	
• between coil and main contacts acc. to EN 60947-1	400 V
Protection class IP	
• on the front	IP20
• of the terminal	IP20
Shock resistance at rectangular impulse	
• at AC	8,3g / 5 ms, 5,3g / 10 ms
• at DC	10g / 5 ms, 7,5g / 10 ms

Shock resistance with sine pulse	
<ul style="list-style-type: none"> • at AC • at DC 	13,5g / 5 ms, 8,3g / 10 ms 15g / 5 ms, 10g / 10 ms
Mechanical service life (switching cycles)	
<ul style="list-style-type: none"> • of the contactor with added auxiliary switch block typical 	3 000 000
Electrical endurance (switching cycles)	150 000
Reference code acc. to DIN EN 81346-2	Q

Ambient conditions

Installation altitude at height above sea level	
<ul style="list-style-type: none"> • maximum 	2 000 m
Ambient temperature	
<ul style="list-style-type: none"> • during operation • during storage 	-25 ... +60 °C -55 ... +80 °C

Main circuit

Number of NO contacts for main contacts	3
Number of NC contacts for main contacts	0
Operating current	
<ul style="list-style-type: none"> • at AC-6b at 690 V at ambient temperature 60 °C rated value 	47.6 A
Operational reactive power at AC-6b	
<ul style="list-style-type: none"> • at 230 V at 50/60 Hz at ambient temperature 60 °C rated value • at 400 V at 50/60 Hz at ambient temperature 60 °C rated value • at 500 V at 50/60 Hz at ambient temperature 60 °C rated value • at 690 V at 50/60 Hz at ambient temperature 60 °C rated value 	6 ... 19 kvar 11 ... 33 kvar 14 ... 41 kvar 19 ... 57 kvar
No-load switching frequency	
<ul style="list-style-type: none"> • at AC • at DC 	500 1/h 500 1/h
Operating frequency at AC-6b	
<ul style="list-style-type: none"> • at 230 V maximum • at 240 V maximum • at 400 V maximum • at 480 V maximum • at 500 V maximum • at 600 V maximum • at 690 V maximum 	100 1/h 100 1/h 100 1/h 70 1/h 65 1/h 45 1/h 36 1/h

Control circuit/ Control

Type of voltage	AC/DC
------------------------	-------

Type of voltage of the control supply voltage	AC/DC
Control supply voltage at AC	
• at 50 Hz rated value	21 ... 28 V
• at 60 Hz rated value	21 ... 28 V
Control supply voltage frequency	
• 1 rated value	50 Hz
• 2 rated value	60 Hz
Control supply voltage	
• at DC rated value	21 ... 28 V
Operating range factor control supply voltage rated value of magnet coil at DC	
• initial value	0.7
• Full-scale value	1.3
Operating range factor control supply voltage rated value of magnet coil at AC	
• at 50 Hz	0.7 ... 1.3
• at 60 Hz	0.7 ... 1.3
Apparent pick-up power of magnet coil at AC	6.7 V·A
Inductive power factor with closing power of the coil	0.98
Apparent holding power of magnet coil at AC	2 V·A
Inductive power factor with the holding power of the coil	0.86
Closing power of magnet coil at DC	5.9 W
Holding power of magnet coil at DC	1.4 W
Closing delay	
• at AC	60 ... 80 ms
• at DC	60 ... 80 ms
Arcing time	10 ... 15 ms
Residual current of the electronics for control with signal <0>	
• at AC at 230 V maximum permissible	7 mA
• at DC at 24 V maximum permissible	16 mA
Auxiliary circuit	
Number of NC contacts for auxiliary contacts	2
• attachable	0
• instantaneous contact	2
Number of NO contacts for auxiliary contacts	1
• attachable	0
• instantaneous contact	1
Operating current of auxiliary contacts at AC-12 maximum	10 A
Operating current of auxiliary contacts at AC-15	
• at 230 V	6 A

<ul style="list-style-type: none"> • at 400 V 	3 A
Operating current of auxiliary contacts at DC-13	
<ul style="list-style-type: none"> • at 24 V • at 60 V • at 110 V • at 125 V • at 220 V 	6 A 2 A 1 A 0.9 A 0.3 A
Contact reliability of auxiliary contacts	0.00000001

UL/CSA ratings

Contact rating of auxiliary contacts according to UL	A600 / Q600
---	-------------

Short-circuit protection

Design of the fuse link	
<ul style="list-style-type: none"> • for short-circuit protection of the main circuit <ul style="list-style-type: none"> — with type of coordination 1 required • for short-circuit protection of the auxiliary switch required 	gG: 100 A (690 V, 50 kA) gG: 10 A (500 V, 1 kA)

Installation/ mounting/ dimensions

Mounting position	+/-180° rotation possible on vertical mounting surface; can be tilted forward and backward by +/- 22.5° on vertical mounting surface
Mounting type	screw and snap-on mounting onto 35 mm standard mounting rail according to DIN EN 50022
Height	150 mm
Width	45 mm
Depth	165 mm
Required spacing	
<ul style="list-style-type: none"> • with side-by-side mounting <ul style="list-style-type: none"> — at the side • for grounded parts <ul style="list-style-type: none"> — at the side 	10 mm 10 mm

Connections/ Terminals









Type of electrical connection	
<ul style="list-style-type: none"> • for main current circuit • for auxiliary and control current circuit 	screw-type terminals screw-type terminals
Type of connectable conductor cross-sections	
<ul style="list-style-type: none"> • for main contacts <ul style="list-style-type: none"> — solid — stranded — single or multi-stranded — finely stranded with core end processing • at AWG conductors for main contacts 	1x (2.5 ... 25 mm ²) 2x (1 ... 2.5 mm ²), 2x (2.5 ... 10 mm ²) 1x (2,5 ... 25 mm ²) 1x (2.5 ... 16 mm ²) 1x (10 ... 4)

Type of connectable conductor cross-sections <ul style="list-style-type: none"> • for auxiliary contacts <ul style="list-style-type: none"> — solid — single or multi-stranded — finely stranded with core end processing • at AWG conductors for auxiliary contacts 	2x (0.5 ... 1.5 mm ²), 2x (0.75 ... 2.5 mm ²), 2x 4 mm ² 2x (0,5 ... 1,5 mm ²), 2x (0,75 ... 2,5 mm ²), 2x 4 mm ² 2x (0.5 ... 1.5 mm ²), 2x (0.75 ... 2.5 mm ²) 2x (20 ... 16), 2x (18 ... 14), 2x 12
Type of minimum connectable cross-section for main contacts at AC-6b <ul style="list-style-type: none"> • at 40 °C • at 60 °C 	1x 16 mm ² 1x 25 mm ²
AWG number as coded connectable conductor cross section for main contacts	10 ... 4

Safety related data

Product function <ul style="list-style-type: none"> • Mirror contact acc. to IEC 60947-4-1 • positively driven operation acc. to IEC 60947-5-1 	No No
Protection against electrical shock	finger-safe

Certificates/ approvals

General Product Approval			EMC	Declaration of Conformity	
 CCC	 CSA	 UL	 EAC	 RCM	 EG-Konf.
Declaration of Conformity	Test Certificates	Marine / Shipping		other	
Miscellaneous	Type Test Certificates/Test Report	 BUREAU VERITAS	 RINA	 RMRS	Confirmation

other



Further information

Information- and Downloadcenter (Catalogs, Brochures,...)
www.siemens.com/sirius/catalogs

Industry Mall (Online ordering system)

<https://mall.industry.siemens.com/mall/en/en/Catalog/product?mlfb=3RT2628-1NB35>

Cax online generator

<http://support.automation.siemens.com/WW/CAXorder/default.aspx?lang=en&mlfb=3RT2628-1NB35>

Service&Support (Manuals, Certificates, Characteristics, FAQs,...)

<https://support.industry.siemens.com/cs/ww/en/ps/3RT2628-1NB35>

Image database (product images, 2D dimension drawings, 3D models, device circuit diagrams, EPLAN macros, ...)

http://www.automation.siemens.com/bilddb/cax_de.aspx?mlfb=3RT2628-1NB35&lang=en

Characteristic: Tripping characteristics, I²t, Let-through current

<https://support.industry.siemens.com/cs/ww/en/ps/3RT2628-1NB35/char>

Further characteristics (e.g. electrical endurance, switching frequency)

<http://www.automation.siemens.com/bilddb/index.aspx?view=Search&mlfb=3RT2628-1NB35&objectype=14&gridview=view1>

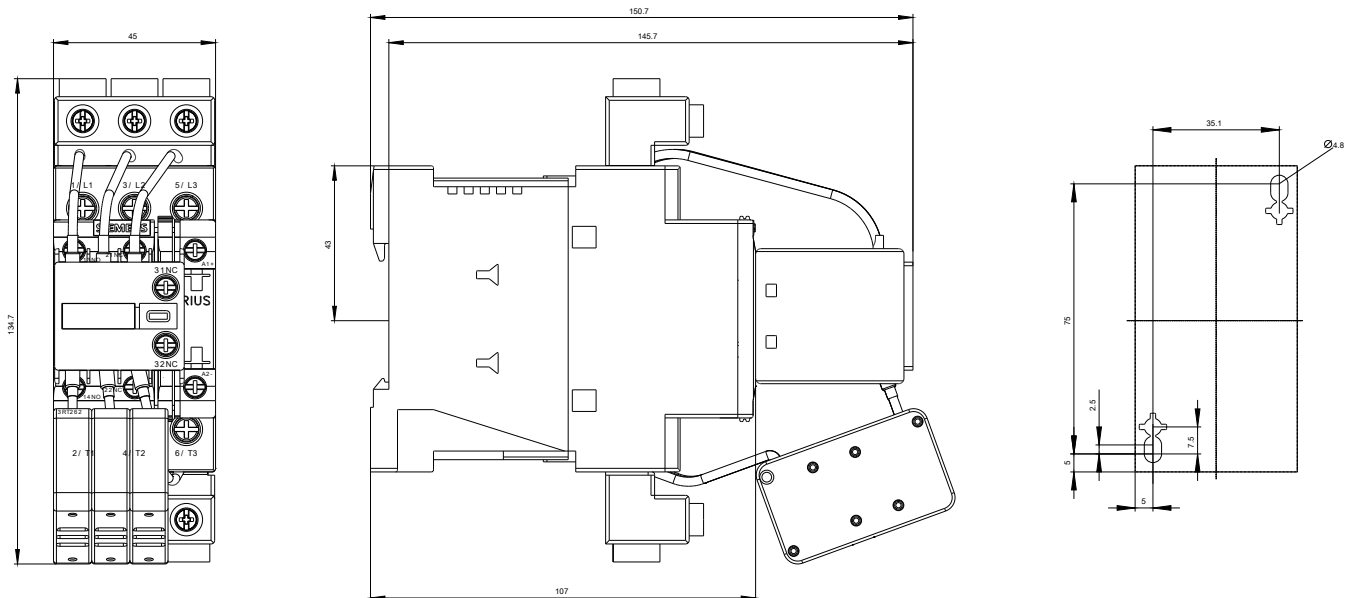

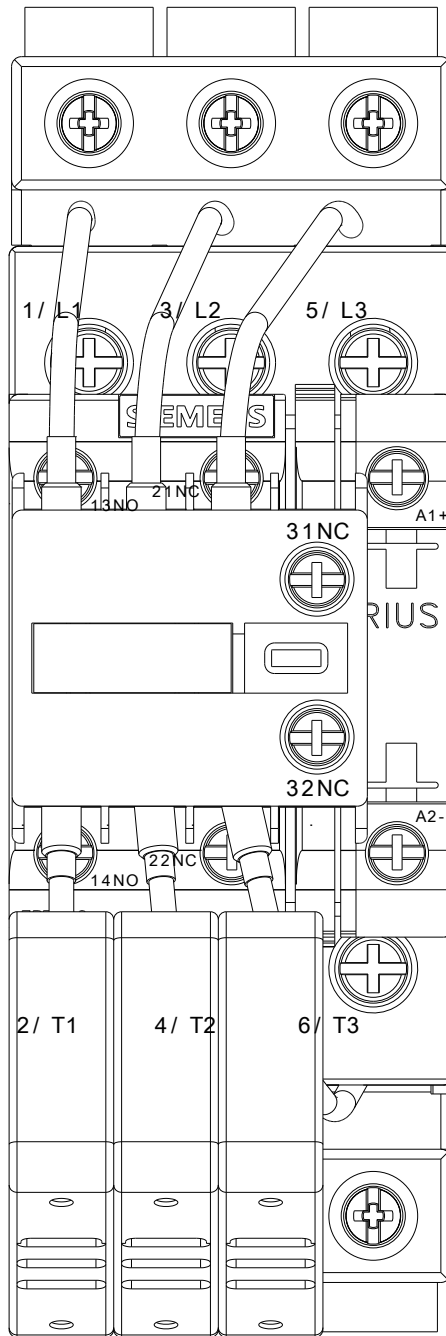

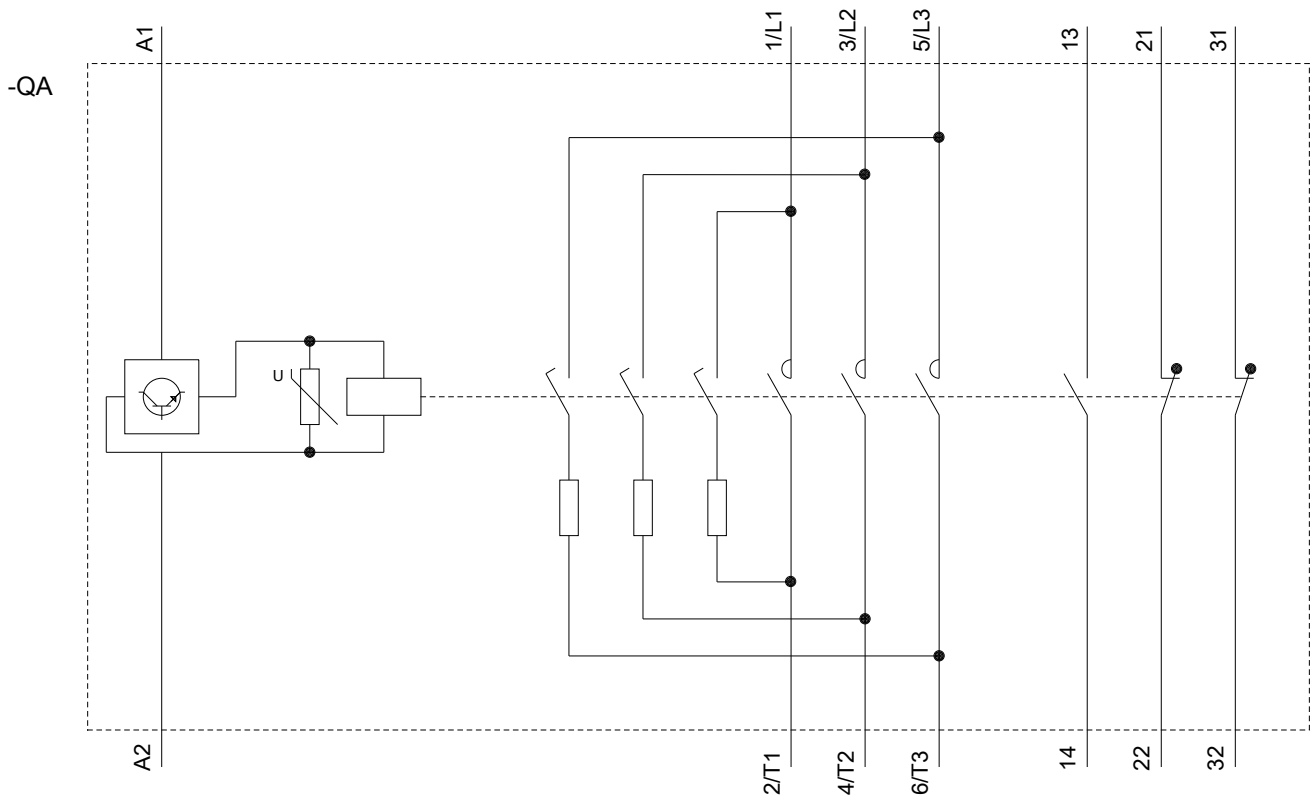

last modified:

09/04/2019