

AlGaInP Visible Laser Diode

ADL-66505TL

6-2D-LD66-010_Rev.00

★660nm 50mW 60°C

Reliable High Power Operation

• Features

1. Highly reliable
2. Higher power
3. High efficiency
4. Low operating current

• Applications

1. High power Laser modules
2. Industrial laser markers / measuring instruments
3. Medical application

• Absolute maximum ratings

Parameter	Symbol	Condition	Rating	Unit
Light output power	P _O	CW	52	mW
Reverse voltage (LD)	V _{RL}	-	2	V
Reverse voltage (PD)	V _{RD}	-	30	V
Forward current (PD)	I _{FD}	-	10	mA
Case temperature	T _C	-	-10~+60	°C
Storage temperature	T _S	-	-40~+85	°C

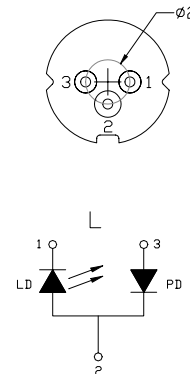
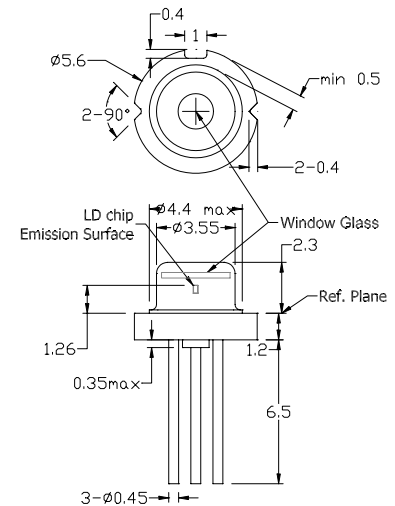

• Electrical and optical characteristics (T_c=25°C)

Parameter	Symbol	Min.	Typ.	Max.	Unit	Conditions
Peak wavelength	λ	650	660	670	nm	P _o =50mW, CW
Threshold current	I _{th}	-	45	60	mA	Kink free
Operating current	I _{op}	-	90	120	mA	
Operating voltage	V _{op}	2.0	2.5	3.0	V	
Differential efficiency	η	0.7	1.0	1.4	mW/mA	P _o =45-50mW
Monitor current*	I _m	0.05	0.2	0.5	mA	P _o =50mW, V _{RD} =5V
Parallel divergence angle	θ_{\parallel}	6	9	13	deg	P _o =50mW
Perpendicular divergence angle	θ_{\perp}	13	17	22	deg	
Parallel FFP deviation angle	$\Delta\theta_{\parallel}$	-3	0	+3	deg	
Perpendicular FFP deviation angle	$\Delta\theta_{\perp}$	-3	0	+3	deg	
Emission point accuracy	$\Delta x \Delta y \Delta z$	-80	0	+80	um	

• Precautions

- * Do not operate the device above maximum ratings. Doing so may cause unexpected and permanent damage to the device.
- * Take precautions to avoid electrostatic discharge and/or momentary power spikes. A change in the characteristics of the laser or premature failure may result.
- * Proper heat sinking of the device assures stability and lifetime. Always ensure that maximum operating temperatures are not exceeded.
- * Observing visible or invisible laser beams with the human eye directly, or indirectly, can cause permanent damage. Use a camera to observe the laser.
- * No laser device should be used in any application or situation where life or property is at risk in event of device failure.
- * Specifications are subject to change without notice. Ensure that you have the latest specification by contacting us prior to purchase or use of the product.

* For reference only. Contents above are subject to change without notice.

AlGaInP Visible Laser Diode

ADL-66505TL
6-2D-LD66-010_Rev.00

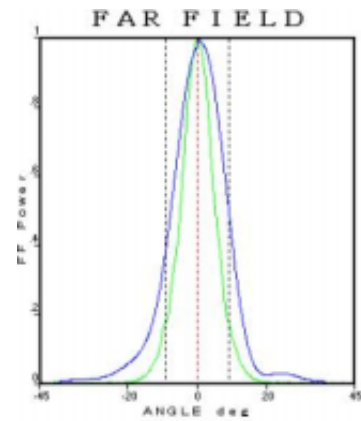
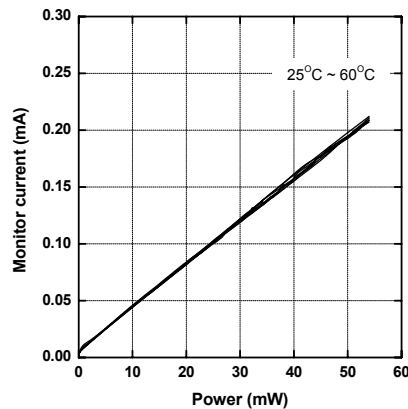
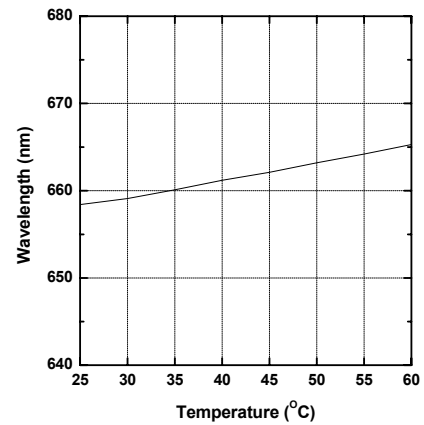
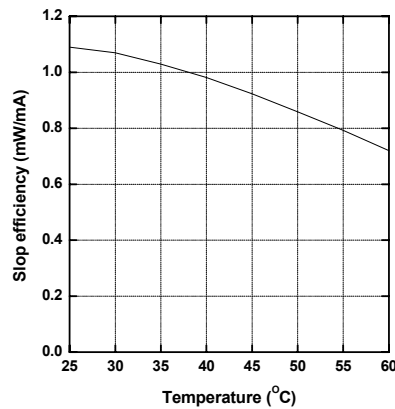
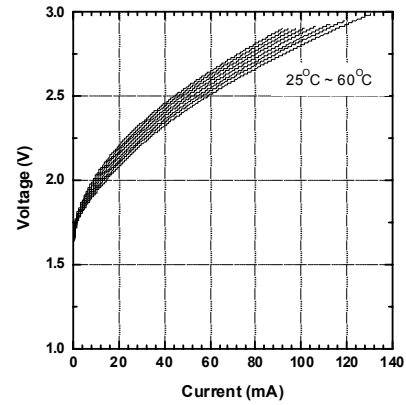
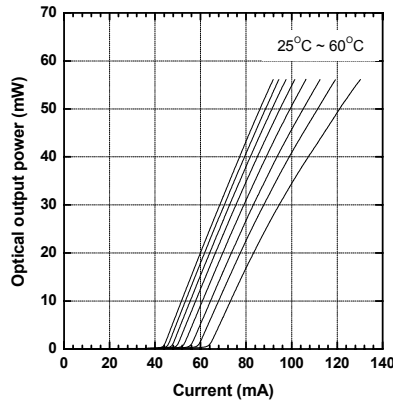

** For reference only. Contents above are subject to change without notice.*

10/14 / V2 / HW / arima / 655nm / adl66505tl