

**RIGOL**  
Innovation or nothing

# DG800系列 函数/任意波形发生器

DG800 Series  
Function/Arbitrary Waveform Generator

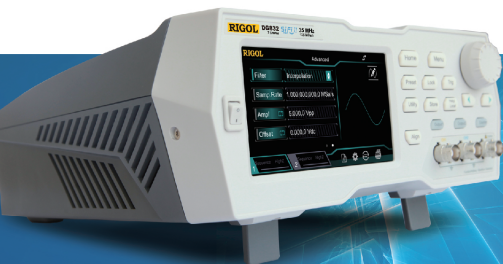

快速指南  
Quick Guide

## 保证和声明

### 版权

©2018 苏州普源精电科技有限公司

### 商标信息

**RIGOL** 是苏州普源精电科技有限公司的注册商标。

### 文档编号

QGB11000-1110

### 声明

- 公司产品受中国及其它国家和地区的专利（包括已取得的和正在申请的专利）保护。
- 本公司保留改变规格及价格的权利。
- 本手册提供的信息取代以往出版的所有资料。
- 本手册提供的信息如有变更，恕不另行通知。
- 对于本手册可能包含的错误，或因手册所提供的信息及演绎的功能以及因使用本手册而导致的任何偶然或继发的损失，**RIGOL** 概不负责。
- 未经 **RIGOL** 事先书面许可，不得影印、复制或改编本手册的任何部分。

### 产品认证

**RIGOL** 认证本产品符合中国国家产品标准和行业产品标准及 ISO9001:2015 标准和 ISO14001:2015 标准，并进一步认证本产品符合其它国际标准组织成员的相关标准。

### 联系我们

如您在使用此产品或本手册的过程中有任何问题或需求，可与 **RIGOL** 联系：

电子邮箱：service@rigol.com

网址：www.rigol.com

### 一般安全概要

1. 请使用所在国家认可的本产品专用电源线。
2. 请确保产品可靠接地。
3. 查看所有终端额定值。
4. 请使用合适的过压保护。
5. 请勿开盖操作。
6. 请勿将异物插入排风口。
7. 请使用合适的保险丝。
8. 避免电路外露。
9. 怀疑产品出故障时，请勿进行操作。
10. 请保持适当的通风。
11. 请勿在潮湿环境下操作。
12. 请勿在易燃易爆的环境下操作。
13. 请保持产品表面的清洁和干燥。
14. 请注意防静电保护。
15. 请注意搬运安全。
16. 请正确使用前面板 BNC 输出连接器，仅允许信号输出。

### 安全术语和符号

#### 本手册中的安全术语：



---

**警告**

警告性声明指出可能会造成人身伤害或危及生命安全的情况或操作。

---



---

**注意**

注意性声明指出可能导致本产品损坏或数据丢失的情况或操作。

---

## 产品上的安全术语:

**DANGER**  
**WARNING**  
**CAUTION**

表示您如果不进行此操作，可能会立即对您造成危害。  
表示您如果不进行此操作，可能会对您造成潜在的危害。  
表示您如果不进行此操作，可能会对本产品或连接到本产品的其他设备造成损坏。

## 产品上的安全符号:



高电压



安全警告



保护性接地端



壳体接地端



测量接地端

## 保养与清洁

### 保养

请勿将仪器放置在长时间受到日照的地方。

### 清洁

请根据使用情况定期对仪器进行清洁。方法如下:

1. 断开电源。
2. 用柔和的清洁剂或清水浸湿软布擦拭仪器外部，请注意不要将水或其他异物通过散热孔进入机箱内。清洁带有液晶显示屏的仪器时，请注意不要划伤 LCD 显示屏。



#### 注意

请勿使任何腐蚀性的液体沾到仪器上，以免损坏仪器。



#### 警告

重新通电之前，请确认仪器已经干透，避免因水分造成电气短路甚至人身伤害。

## 文档概述

本文档介绍初次使用DG800系列函数/任意波形发生器时需要了解的信息，包括产品简介、连接电源、开机检查以及远程控制等。

### 提示

本手册的最新版可登陆 **RIGOL** 网址 ([www.rigol.com](http://www.rigol.com)) 进行下载。

## 文档格式的约定

### 1. 按键:

本手册中通常用“文本框+文字(加粗)”表示前面板上的一个按键，如 **Utility**。

### 2. 菜单标签:

本手册通常用“字符底纹+文字(加粗)”表示一个菜单标签，如 **系统设置**。

### 3. 连接器:

本手册中通常用“方括号+文字(加粗)”表示前面板或后面板上的一个连接器。例如：**[Counter]**。

#### 4. 操作步骤:

本手册中通常用箭头“→”表示下一步操作。例如：**Utility**→**系统设置**表示按下前面板上的**Utility**功能键后再触摸点击**系统设置**菜单标签。

#### 文档内容的约定

DG800系列函数/任意波形发生器包含以下型号。如无特殊说明，本手册以DG832为例介绍其使用方法。

型号	通道数	最大输出频率
DG812	2	10MHz
DG811	1	10MHz
DG822	2	25MHz
DG821	1	25MHz
DG832	2	35MHz
DG831	1	35MHz

#### 一般性检查

##### 1. 检查运输包装

如运输包装已损坏，请保留被损坏的包装或防震材料，直到货物经过完全检查且仪器通过电性和机械测试。

因运输造成仪器损坏，由发货方和承运方联系赔偿事宜。**RIGOL**公司恕不进行免费维修或更换。

##### 2. 检查整机

若存在机械损坏或缺失，或者仪器未通过电性和机械测试，请联系您的**RIGOL**经销商。

##### 3. 检查随机附件

请根据装箱单检查随机附件，如有损坏或缺失，请联系您的**RIGOL**经销商。

#### 产品简介

DG800系列函数/任意波形发生器是一款集函数发生器、任意波形发生器、噪声发生器、脉冲发生器、谐波发生器、模拟/数字调制器、频率计等功能于一身的多功能信号发生器。多功能、高性能、高性价比、便携式、触摸屏操作等特点为教育、研发、生产、测试等行业提供了新的选择。前面板、后面板和用户界面（显示屏）的简要介绍请分别参考图1、图2和图3。



图 1 前面板

表 1 前面板说明

编号	说明	编号	说明
1	电源键	8	方向键
2	同相位键	9	旋钮
3	CH1 输出连接器	10	Menu 键
4	通道控制区	11	Home 键
5	CH2 输出连接器	12	功能键
6	Counter 测量信号输入连接器	13	LCD 触摸显示屏
7	频率计	—	—

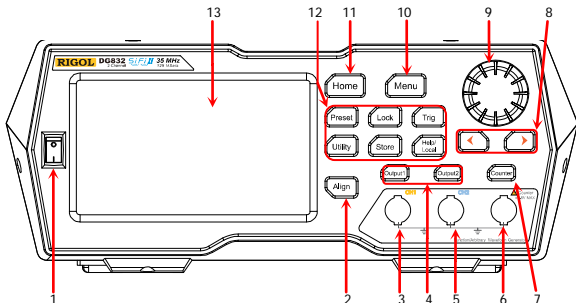

图 2 后面板

表 2 后面板说明

编号	说明	编号	说明
1	10MHz 输入/输出连接器	4	USB HOST
2	CH1 同步/外调制/触发连接器	5	USB DEVICE
3	CH2 同步/外调制/触发连接器	6	AC 电源插口

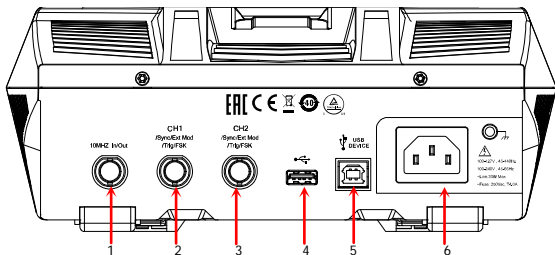

图 3 用户界面

表 3 用户界面标识

编号	名称	说明
1	通道输出配置状态栏	显示各通道当前的输出配置。
2	界面切换	左侧圆点置灰，右侧圆点点亮，此时向右滑动屏幕切换至波形选择界面。 左侧圆点点亮，右侧圆点置灰，此时向左滑动屏幕切换至当前波形参数设置界面。
3	信息设置	📁: 打开 Store 界面。 ⚙️: 打开 Utility 界面。 🔄: 执行通道复制功能。 🖨️: 执行屏幕打印操作。
4	状态栏	🔒: 表示前面板按键和屏幕被锁定。 🔊: 表示关闭蜂鸣器。 🖱️: 表示仪器处于程控模式。 🌐: 表示使用网线成功将仪器连接至局域网。 📁: 表示成功连接 U 盘。
5	波形	显示各通道当前选择的波形。
6	界面标签	显示当前界面的标签。
7	频率	显示各通道当前波形的频率。
8	幅度	显示各通道当前波形的幅度。
9	偏移	显示各通道当前波形的直流偏移。
10	相位	显示各通道当前波形的相位。

## 使用前准备

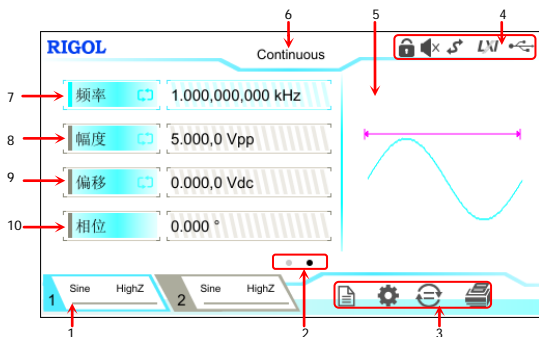
### 连接电源

请使用附件提供的电源线将信号发生器连接至 AC 电源中，如下图所示。本信号发生器支持 100-127V, 45-440Hz 或 100-240V, 45-65Hz 规格的交流电源，最大输入功率不超过 30W。当通过该连接器将信号发生器连接到交流电源时，仪器自动调节至正确的电压范围，无需手动选择电压范围。

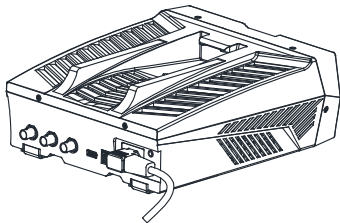

**注意**  
为避免电击，请确保仪器正确接地。

## 开机检查

正确连接电源后，按下前面板的电源键  打开信号发生器。开机过程中仪器执行初始化过程和自检过程。结束后，屏幕进入默认界面。

## 设置系统语言

DG800 支持多种语言菜单。您可以按 **Utility** → **系统设置**，然后触摸点击 **Language** 标签右侧的参数选择框，选择所需的语言类型。

## 使用内置帮助系统

DG800 对于前面板上的每个功能按键以及当前显示界面都提供了帮助信息。用户可在操作仪器的过程中随时查看各项帮助信息。

### 1. 获取前面板按键帮助

按下 **Help/Local** 键，然后再按下你所需要获得帮助的前面板按键，仪器界面显示该键的帮助信息。

### 2. 获取常用帮助主题

按下前面板 **Help/Local** 键，弹出如下图所示的界面，触摸点击屏幕中“帮助”，进入帮助列表界面。此时，您可通过上下滑动屏幕或旋转旋钮滚动列表，然后触摸点击选中相应的帮助项，仪器界面显示该项目的帮助信息。

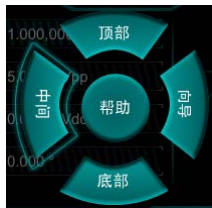

### 3. 获取界面数据说明

按下前面板 **Help/Local** 键，弹出界面如上图所示。然后触摸点击屏幕“中间”，可显示对当前界面中间部分数据的解释说明；触摸点击“顶部”，可显示对当前界面上部分数据的解释说明；触摸点击“底部”，可显示对当前界面下部分数据的解释说明；触摸点击“向导”，可进入

向导界面提示您进行操作。

#### 4. 帮助的翻页操作



当帮助信息为多页显示时，您可通过手指上下滑动屏幕以滚动帮助信息页面。

#### 5. 关闭当前的帮助信息

当仪器界面显示帮助信息时，用户按下前面板 **Help/Local** 键，将关闭当前显示的帮助信息。

### 实例：输出正弦波

本节主要介绍如何从 **[CH1]** 连接器输出一个正弦波（频率为 20kHz，幅度为 2.5Vpp，偏移量为 500mVdc，起始相位为 90°）。

- 选择输出通道：**按下前面板 **Output1** 键（或通过触摸点击通道输出配置状态栏 ），选中 CH1 通道。此时通道界面以红色显示。
- 选择正弦波：**按下前面板 **Menu** 键，在弹出的波形选择界面触摸点击 **Continuous** → **Sine** 图标，仪器自动跳转至正弦波参数设置界面。
- 设置频率：**触摸点击 **频率** 标签右侧的参数输入框，通过弹出的数字键盘输入 20，选择单位“kHz”，点击“Ok”。
- 设置幅度：**触摸点击 **幅度** 标签右侧的参数输入框，通过弹出的数字键盘输入 2.5，选择单位“Vpp”，点击“Ok”。
- 设置偏移电压：**触摸点击 **偏移** 标签右侧的参数输入框，通过弹出的数字键盘输入 500，选择单位“mVdc”，点击“Ok”。
- 设置起始相位：**触摸点击 **相位** 标签右侧的参数输入框，通过弹出的数字键盘输入 90，选择单位“°”，点击“Ok”。
- 启用通道输出：**按 **Output1** 键（或通过触摸点击通道输出配置状态栏 ，在通道设置界面打开通道输出），**Output1** 键背灯点亮并且通道状态条呈高亮状态（即 ），**[CH1]** 连接器以当前配置输出正弦波信号。
- 观察输出波形：**使用 BNC 连接线将 DG800 的 **[CH1]** 与示波器相连接，由示波器观察输出波形。

### 远程控制

DG800 系列函数/任意波形发生器可以通过 USB 或 GPIB（配合 **RIGOL** 的 USB-GPIB 转接模块）接口与计算机进行通信从而实现远程控制。远程控制基于 SCPI（Standard Commands for Programmable Instruments）命令集实现。DG800 支持两种远程控制方式：用户自定义编程和使用 PC 软件（如 **RIGOL** Ultra Sigma）。

当仪器处于远程控制状态时，前面板按键以及触摸屏被锁定（电源开关键  和 **Help/Local** 键除外）。此时，您可以按 **Help/Local** 退出远程模式。

### 更多产品信息

#### 1. 获取设备信息

按 **Utility** → **系统信息**，您可获取设备信息，包括设备型号、设备序列号以及软件版本号。

#### 2. 查看选件安装状态

按 **Utility** → **选件**，您可查看所有选件的安装状态。

欲了解本产品更多信息，请查阅相关手册（您可登录 **RIGOL** 网站 [www.rigol.com](http://www.rigol.com) 下载）。

《DG800 用户手册》：提供本产品的功能介绍及操作方法、远程控制方法、在使用过程中可能出现的故障及处理方法以及订货信息；

《DG800 编程手册》：提供本产品的 SCPI 命令集以及编程实例；

《DG800 数据手册》：提供本产品的主要特色和技术指标。



## Guaranty and Declaration

### Copyright

© 2018 **RIGOL** (SUZHOU) TECHNOLOGIES INC. All Rights Reserved.

### Trademark Information

**RIGOL** is a registered trademark of **RIGOL** (SUZHOU) TECHNOLOGIES INC.

### Publication Number

QGB11100-1110

### Notices

- **RIGOL** products are covered by P.R.C. and foreign patents, issued and pending.
- **RIGOL** reserves the right to modify or change parts of or all the specifications and pricing policies at the company's sole decision.
- Information in this publication replaces all previously released materials.
- Information in this publication is subject to change without notice.
- **RIGOL** shall not be liable for either incidental or consequential losses in connection with the furnishing, use, or performance of this manual, as well as any information contained.
- Any part of this document is forbidden to be copied, photocopied, or rearranged without prior written approval of **RIGOL**.

### Product Certification

**RIGOL** guarantees that this product conforms to the national and industrial standards in China as well as the ISO9001:2015 standard and the ISO14001:2015 standard. Other international standard conformance certifications are in progress.

### Contact Us

If you have any problem or requirement when using our products or this manual, please contact **RIGOL**.

E-mail: [service@rigol.com](mailto:service@rigol.com)

Website: [www.rigol.com](http://www.rigol.com)

### General Safety Summary

1. Only the exclusive power cord designed for the instrument and authorized for use within the local country could be used.
2. Ensure that the instrument is safely grounded.
3. Observe all terminal ratings.
4. Use proper overvoltage protection.
5. Do not operate without covers.
6. Do not insert objects into the air outlet.
7. Use the proper fuse.
8. Avoid circuit or wire exposure.
9. Do not operate the instrument with suspected failures.
10. Provide adequate ventilation.
11. Do not operate in wet conditions.
12. Do not operate in an explosive atmosphere.
13. Keep instrument surfaces clean and dry.
14. Prevent electrostatic impact.
15. Handle with caution.
16. Please use the front-panel BNC output connector correctly. It is only allowed to output signal.

### Safety Notices and Symbols

#### Safety Notices in this Manual:



---

**WARNING**

Indicates a potentially hazardous situation or practice which, if not avoided, will result in serious injury or death.

---

**CAUTION**

Indicates a potentially hazardous situation or practice which, if not avoided, could result in damage to the product or loss of important data.

**Safety Terms on the Product:**

**DANGER** It calls attention to an operation, if not correctly performed, could result in injury or hazard immediately.

**WARNING** It calls attention to an operation, if not correctly performed, could result in potential injury or hazard.

**CAUTION** It calls attention to an operation, if not correctly performed, could result in damage to the product or other devices connected to the product.

**Safety Symbols on the Product:**

Hazardous  
Voltage



Safety  
Warning



Protective Earth  
Terminal



Chassis Ground



Test Ground

**Care and Cleaning****Care**

Do not store or leave the instrument where it may be exposed to direct sunlight for long periods of time.

**Cleaning**

Clean the instrument regularly according to its operating conditions.

1. Disconnect the instrument from all power sources.
2. Clean the external surfaces of the instrument with a soft cloth dampened with mild detergent or water. Avoid having any water or other objects into the chassis via the heat dissipation hole. When cleaning the LCD, take care to avoid scarifying it.

**CAUTION**

To avoid damage to the instrument, do not expose it to caustic liquids.

**WARNING**

To avoid short-circuit resulting from moisture or personal injuries, ensure that the instrument is completely dry before connecting it to the power supply.

**Document Overview**

This manual introduces some basic information that you should know when you use the DG800 series function/arbitrary waveform generator for the first time. It contains the following contents: product overview, how to connect the instrument to the AC power, turn-on checkout, and remote control.

**Tip**

For the latest version of this manual, download it from the official website of **RIGOL** ([www.rigol.com](http://www.rigol.com)).

## Format Conventions in this Manual

### 1. Keys:

The keys on the front panel are usually denoted by the format of "Key Name (Bold) + Text Box". For example, **Utility**.

### 2. Menu Labels:

The menu labels are usually denoted by the format of "Menu Word (Bold) + Character Shading". For example, **System Setting**.

### 3. Connectors:

The connectors on the front or rear panel are usually denoted by the format of "Connector Name (Bold) + Square Brackets (Bold)". For example, **[Counter]**.

### 4. Operation Procedures:

"→" represents the next step of operation. For example, **Utility**→**System Setting** indicates pressing **Utility** on the front panel and then pressing the menu label **System Setting**.

## Content Conventions in this Manual

DG800 series function/arbitrary waveform generator includes the following models. Unless otherwise specified, this manual takes DG832 as an example to illustrate the operation methods of the DG800 series.

Model	No. of Channels	Max. Output Frequency
DG812	2	10 MHz
DG811	1	10 MHz
DG822	2	25 MHz
DG821	1	25 MHz
DG832	2	35 MHz
DG831	1	35 MHz

## General Inspection

### 1. Inspect the packaging

If the packaging has been damaged, do not dispose the damaged packaging or cushioning materials until the shipment has been checked for completeness and has passed both electrical and mechanical tests.

The consigner or carrier shall be liable for the damage to the instrument resulting from shipment. **RIGOL** would not be responsible for free maintenance/rework or replacement of the instrument.

### 2. Inspect the instrument

In case of any mechanical damage, missing parts, or failure in passing the electrical and mechanical tests, contact your **RIGOL** sales representative.

### 3. Check the accessories

Please check the accessories according to the packing lists. If the accessories are damaged or incomplete, please contact your **RIGOL** sales representative.

## Product Overview

As a multi-functional signal generator, DG800 series function/arbitrary waveform generator integrates many instruments into 1, such as function generator, arbitrary waveform generator, noise generator, pulse generator, harmonic generator, analog/digital modulator, and frequency counter. As a multi-functional and portable instrument, it offers you a new choice in education, R&D, production, measurement, and other industries with its user-friendly touch screen and high performance at an unprecedented price point.

For descriptions of the front panel, refer to Figure 1; for descriptions of the rear panel, refer to Figure 2; and for descriptions of the user interface (LCD), refer to Figure 3.

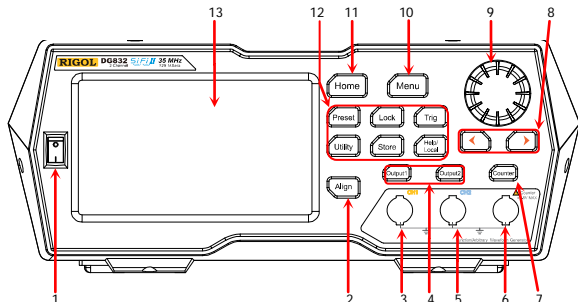

Figure 1 Front Panel

Table 1 Front Panel Description

No.	Description	No.	Description
1	Power Key	8	Arrow Keys
2	Align Phase Key	9	Knob
3	CH1 Output Connector	10	Menu Key
4	Channel Control Area	11	Home Key
5	CH2 Output Connector	12	Function Keys
6	Counter Measurement Signal Input Connector	13	LCD Touch Screen
7	Frequency Counter	---	---

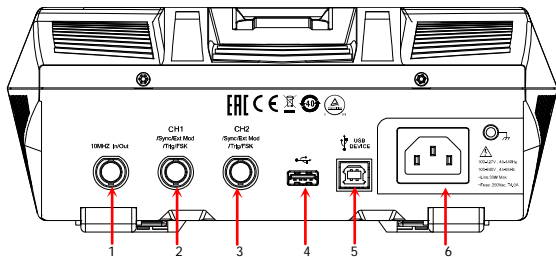

Figure 2 Rear Panel

Table 2 Rear Panel Description

No.	Description	No.	Description
1	10MHz In/Out Connector	4	USB HOST
2	CH1 Sync/Ext Mod/Trig/FSK Connector	5	USB DEVICE
3	CH2 Sync/Ext Mod/Trig/FSK Connector	6	AC Power Cord Connector

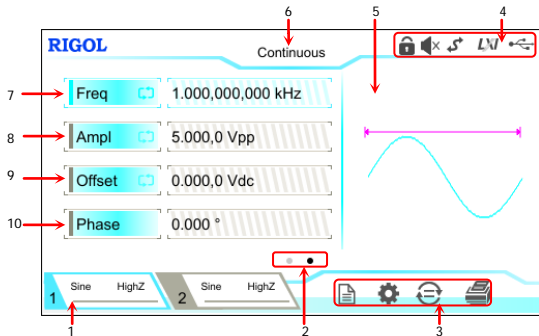

Figure 3 User Interface

Table 3 User Interface Icons

No.	Name	Description
1	Channel Output Configuration Status Bar	Displays the current output configuration of the channel.
2	Interface Switchover	When left point is grayed out and the right point is illuminated, sliding right on the touch screen can switch to the waveform selection interface. When the left point is illuminated and the right point is grayed out, sliding left on the touch screen can switch to the current waveform parameter setting interface.
3	Information Setting	<ul style="list-style-type: none"> <li>📁: opens the Store interface.</li> <li>⚙️: opens the Utility interface.</li> <li>🔄: performs the channel copy function.</li> <li>🖨️: performs the screen print operation.</li> </ul>
4	Status Bar	<ul style="list-style-type: none"> <li>🔒: indicates that the front-panel keys and the screen are locked.</li> <li>🔇: indicates that the beeper is disabled.</li> <li>🔌: indicates that the instrument is in programming-controlled mode.</li> <li>🌐: indicates that the instrument has been successfully connected to the local area network by using the network cable.</li> <li>📁: indicates that a USB storage device is found.</li> </ul>
5	Waveform	Displays the currently selected waveform of each channel.
6	Interface Label	Displays the label of the current interface.
7	Frequency	Displays the frequency of the current waveform of each channel.

8	Amplitude	Displays the amplitude of the current waveform of each channel.
9	Offset	Displays the DC offset of the current waveform of each channel.
10	Phase	Displays the phase of the current waveform of each channel.

## To Prepare for Use

### To Connect to AC Power

Please use the power cord provided in the accessories to connect the signal generator to the AC power source, as shown in the figure below. The rated AC power source supported by the signal generator is (100-127 V, 45-440Hz) or (100-240 V, 45-65Hz), and its maximum input power shall not exceed 30 W. When the signal generator is connected to the AC power source via the power cord, the instrument automatically adjusts itself to within the proper voltage range, and you do not need to select the voltage range manually.

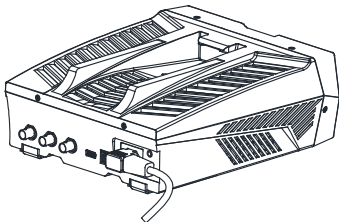

#### CAUTION

To avoid electric shock, ensure that the instrument is correctly grounded.

### Turn-on Checkout

After connecting the instrument to the power source properly, press **▶** on the front panel to start the signal generator. During the start-up, the instrument will undergo the initialization and self-check process. Then, it will enter a default interface.

### To Set the System Language

DG800 arbitrary waveform generator supports multiple languages. You can press **Utility** → **System Setting**, and then select a desired language from the **Language** drop-down list.

### To Use the Built-in Help System

DG800 series provides the help information for each front-panel function menu and the current display interface. You can view the help information if you have any questions during the operation process.

#### 1. Obtain the help information of the front panel keys

To get the help information about the front-panel keys, press the **Help/Local** key first, and

then press the desired key for the help information. Then, the corresponding help information is displayed.

## 2. Obtain the common help topics

Press **Help/Local** on the front panel, and then the following interface is displayed below. Tap "Help" to enter the help interface. At this time, you can tap on the touch screen to move up and down the help items or rotate the knob to scroll up and down the list to select the desired help item. Then, the help information for the item is displayed in the interface.



## 3. Obtain the descriptions of the data in the interface

Press **Help/Local** on the front panel to enter the interface, as shown above. Tap "Center" to view the descriptions for the data in the center of the current interface. Tap "Top" to view the descriptions for the data in the top part of the current interface. Tap "Bottom" to view the descriptions for the data in the bottom part of the current interface. Tap "Guide" to enter the guide interface.

## 4. Page up/down operation

When the help information is displayed in multiple pages, you can tap to move up and down the touch screen to view the help information.



## 5. Close the current help information

When the help information is displayed in the interface, press **Help/Local** on the front panel to close the help information currently displayed on the screen.

### Example: To Output Sine

This section mainly introduces how to output Sine waveforms (frequency 20 kHz, amplitude 2.5 Vpp, offset 500 mVdc, start phase 90°) from the **[CH1]** connector.

- 1. Select the output channel:** Press **Output1** on the front panel or tap the channel output configuration status bar to select CH1. At this time, the channel is indicated in red in the status bar.
- 2. Select Sine waveforms:** Press **Menu** on the front panel, and then the waveform selection interface is displayed. Tap **Continuous** and then select the "Sine" icon to go to the sine waveform parameter setting interface automatically.
- 3. Set frequency:** Tap the **Freq** parameter input field to input 20 with the pop-up numeric keypad, and then select "kHz" as the unit. Tap "Ok".
- 4. Set amplitude:** Tap the **Ampl** parameter input field to input 2.5 with the pop-up numeric keypad, and then select "Vpp" as the unit. Tap "Ok".

- 5. Set offset voltage:** Tap the **Offset** parameter input field to input 500 with the pop-up numeric keypad, and then select "mVdc" as the unit. Tap **"Ok"**.
- 6. Set start phase:** Tap the **Phase** parameter input field to input 90 with the pop-up numeric keypad, and then select "" as the unit. Tap **"Ok"**.
- 7. Enable channel output:** Press **Output1** or tap the channel output configuration status bar  to enable the channel output. Then, the backlight of **Output1** key is illuminated and the channel status is highlighted () , and the Sine signal is output from the **[CH1]** connector based on the current configurations.
- 8. Observe the output waveforms:** Connect the **[CH1]** connector of the DG800 series to the oscilloscope by using the BNC cable, and then you can view the output waveforms from the oscilloscope.

## Remote Control

DG800 series function/arbitrary waveform generator can be connected to the PC via the USB or GPIB (working with **RIGOL** USB-GPIB interface converter) to realize remote control. The remote control can be realized by using SCPI (Standard Commands for Programmable Instruments) commands. DG800 series signal generator supports two ways of remote control: user-defined programming and PC software (e.g. **RIGOL** Ultra Sigma).

When the instrument is in remote control, the front panel keys (except the Power key  and **Help/Local** key) and the touch screen are locked. At this time, you can press **Help/Local** to exit the remote mode.

## More Product Information

### 1. Obtain the device information

Press **Utility**→**System Info** to obtain the information of the instrument, including the device model, device serial number, as well as software version number.

### 2. Check the option installation

Press **Utility**→**Option** to view the installation status of all the options.

For more information about this instrument, refer to the relevant manuals by logging in to the official website of **RIGOL** ([www.rigol.com](http://www.rigol.com)) to download them.

*DG800 User's Guide:* introduces the functions of the instrument and the operation methods, remote control methods, possible failures and solutions in using the instrument, and order information;

*DG800 Programming Guide:* provides detailed descriptions of SCPI commands and programming instances of the instrument.

*DG800 Datasheet:* provides the main features and technical specifications of the instrument.

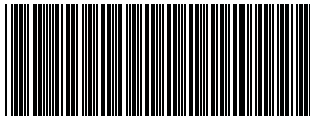

ZN1020004477