



Item No.:

1623 45 11

1623 60 11 (Comfort DuoFern Plus)

1615 45 11 (Small belt)



Dear Customer,

EN

With your purchase of **RolloTron Comfort DuoFern**, you have chosen a quality product manufactured by RADEMACHER. Thank you for the trust you have placed in us.

This roller shutter belt winder has been designed both in order to provide optimal convenience and operability as well as to ensure solidity and durability. Having applied uncompromising quality standards, and carried out thorough testing, we are proud to be able to present you this innovative product.

It's brought to you by all the highly-qualified personnel here at RADEMACHER.



These instructions...

...describe how to install the equipment, connect the electrical system and operate your roller shutter belt winder.



Before you begin, please read these instructions through completely and follow all the safety instructions.

This manual is a component of the product. Please store it in an easily accessible place. When passing the RolloTron Comfort DuoFern on to a third party, this manual must be passed on as well.

Damage resulting from non-compliance with these instructions and safety instructions will void the guarantee. We assume no liability for any consequential damage.

i	Dear Customer,	2		
1.	Hazard symbols	5		
1.1	Levels of danger and signal words	5		
1.2	Symbols and depictions used	5		
2.	Scope of delivery (item no. 1623 45 11).....	6		
3.	General view (item no. 1623 45 11)	7		
4.	Display overall view.....	8		
5.	Safety instructions	9		
5.1	Proper use.....	10		
5.2	Improper use.....	11		
5.3	Required expert knowledge of the installer	11		
6.	Permissible roller shutter belts.....	12		
7.	Functional description	13		
7.1	Description of the safety functions	14		
7.2	Table 3: DuoFern network function table	15		
7.3	Overview of local functions	16		
8.	General assembly instructions.....	17		
8.1	You will require the following tools	17		
8.2	Preparation for installation.....	18		
9.	Safety instructions for electrical connection	20		
9.1	Electrical connection	21		
10.	Drawing in and fastening the belt.....	22		
11.	Mounting the RolloTron Comfort DuoFern	24		
12.	Brief description of the button functions	25		
12.1	Brief description of the standard display and main menu	26		
			12.2	Introduction to opening and closing the menus
				27
13.	Initial commissioning with the help of the installation wizard.....	28		
14.	Manual operation	32		
14.1	Moving to a target position	33		
14.2	Displaying weather data	34		
15.	DuoFern settings; brief description.....	35		
15.1	Menu 9.9.1 - Logging DuoFern devices on/off	36		
15.2	Menu 9.9.2 - Set DuoFern mode	39		
15.3	Menu 9.9.3 - Setting the solar mode.....	41		
15.4	Menu 9.9.4 - Switch weather data on/off.....	43		
15.5	Menu 9.9.5 - Display DuoFern address.....	44		
16.	Menu overview / main menu	45		
16.1	[AUTO] Automatic mode; brief description	46		
16.1.1	Menu 1- Automatic mode on / off... ..	47		
16.2	Switching times (opening and closing times) [▲/▼]; brief description	48		
16.2.1	Menu 2 - Configuration of opening and closing times [▲/▼]	51		
16.3	Automatic dusk function; brief description	55		
16.3.1	Menu 3 - Customising the automatic dusk function [☾]	56		

16.4 Automatic solar function; brief description... 58	17. Erase all settings, software reset..... 74
16.4.1 Menu 4 - Configuring the auto- matic solar function [☀] and sunshine position 60	18. Carry out hardware reset..... 74
16.5 Automatic dawn function; brief description..... 62	19. Removing the RolloTron Comfort DuoFern (e.g. in the event of a move)..... 75
16.5.1 Menu 5 - Customising the auto- matic dawn time [☀] 63	20. Removing the belt in the event of unit failure 77
16.6 Random function; brief description 64	21. What to do if... ? 78
16.6.1 Menu 6 - Configuring the random function [🎲] 64	22. Information about maintenance and care of your equipment..... 81
16.7 Menu 9 - System settings [⚙]; brief description..... 65	23. Technical Specifications 82
16.7.1 Menu 9.1 - Set time / date [🕒] and Postcode [PLZ] 66	24. Tractive force diagrams..... 83
16.7.2 Menu 9.2 - End point configu- ration [📏] 67	25. Factory settings 84
16.7.3 Menu 9.3 - Configure ventilation position [▼ 📏]..... 68	26. Time zone table 85
16.7.4 Menu 9.4 - Configure continuous display lighting 69	27. Simplified EU Declaration of Conformity 86
16.7.5 Menu 9.5 - Weekly pro- gramme [📅] configuration..... 70	28. Accessories 86
16.7.6 Menu 9.6 - Configure motor speed..... 71	29. Warranty conditions..... 87
16.7.7 Menu 9.7 - Switch button lock on/off..... 72	
16.7.8 Menu 9.9 - DuoFern settings / overview..... 73	

i 1. Hazard symbols



Danger of fatal electric shock



Danger area / dangerous situation

i 1.1 Levels of danger and signal words

 **DANGER!**

This hazard will result in serious injury or death if not avoided.

 **WARNING!**

This hazard may result in serious injury or death if not avoided.

 **CAUTION!**

This hazard may result in minor or moderate injury if not avoided.

 **ATTENTION!**

This hazard may lead to property damage.

i 1.2 Symbols and depictions used

1. Steps to be taken
- 2.

◆ Itemisation

1. List



Please read the respective manual



further useful information



2. Scowpe of delivery (item no. 1623 45 11) *

EN

* also applies to item numbers 1623 60 11 / 1615 45 11

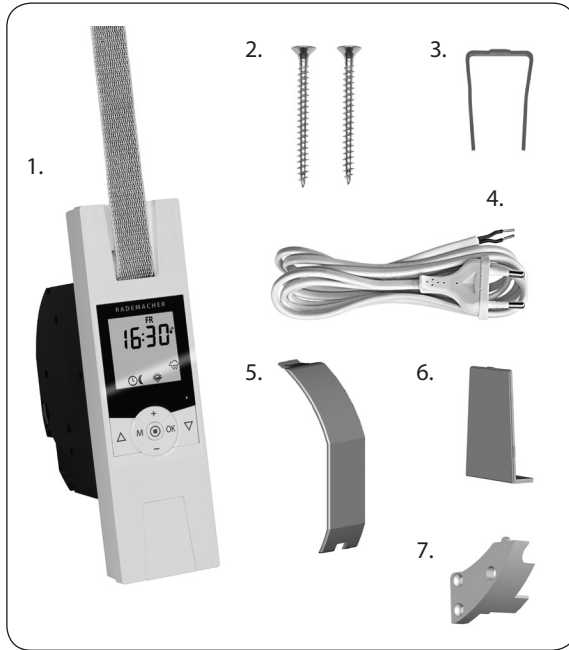

Legend

1. Belt winder RolloTron Comfort DuoFern or Comfort DuoFern Plus
2. 2 x assembly screws (4 x 55 mm)
3. Disengaging bracket (in housing)
4. Connection cable with Euro-plug
5. Reel compartment cover
6. Cover plate
7. Traction relief mechanism incl. assembly screws

After unpacking please check and compare ...

the contents of the package with the above specified.

Check the details on the type plate

Check that the voltage / frequency on the type plate corresponds to the local mains conditions.



3. General view (item no. 1623 45 11) *

* also applies to item numbers 1623 60 11 / 1615 45 11

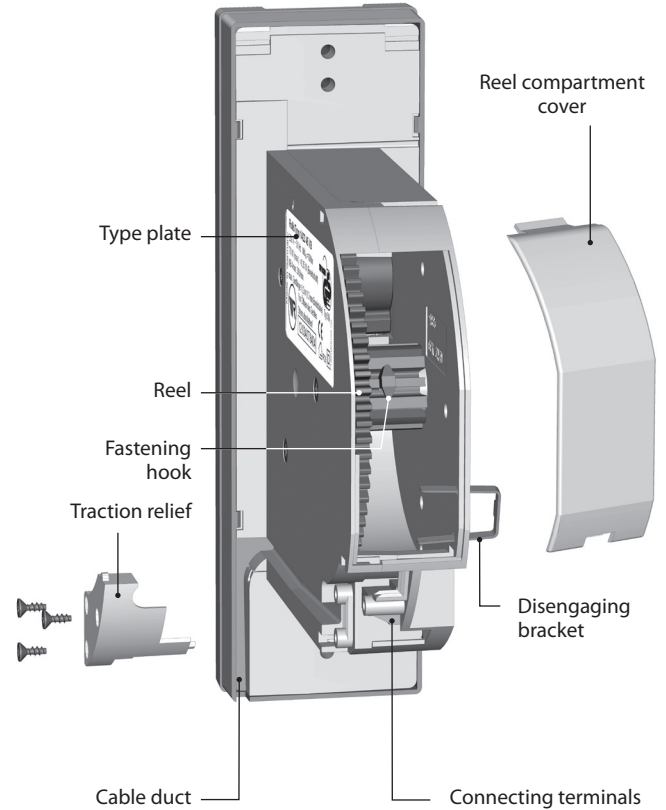
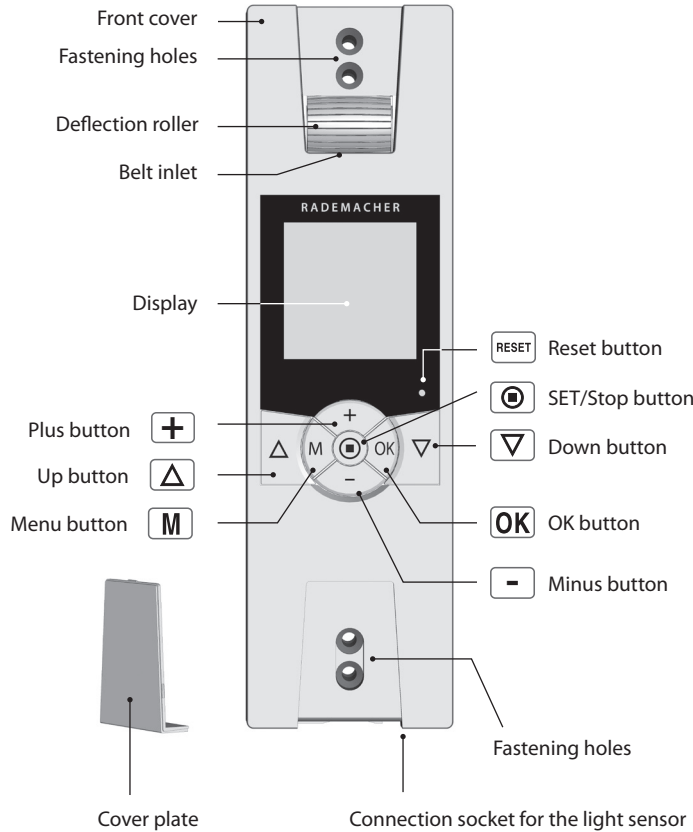



4. Display overall view

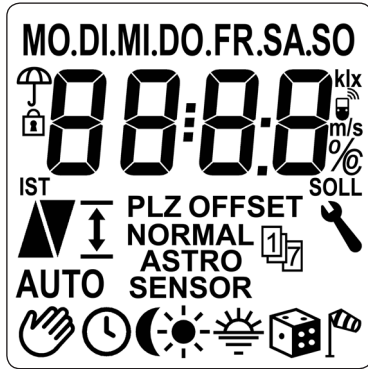

Display symbol legend

[MO ... SO]	(MON...SUN) Week days	[AUTO]	AUTO - automatic mode
	Time / setting parameters		Automatic mode off
	Rain display		Timer periods
	Button lock		Automatic dusk function
[IST]	ACTUAL value		Automated solar function
	Direction of travel - up / down		Automatic dawn function
	End point setting		Random function
[PLZ]	Postcode		Wind display
[OFFSET]	OFFSET (for Astro time)		System settings
	Weekly programme		DuoFern settings
[NORMAL]	Switching modes	[m/s]	Wind speed (metres/second)
[ASTRO]		[klx]	Brightness (kilolux)
[SENSOR]		[°C]	Temperature (°C)
		[%]	Dimension (percent)
		[SOLL]	SET - value



The use of defective equipment can lead to personal injury and damage to property (electric shocks, short circuiting).

- ◆ Never use defective or damaged equipment.
- ◆ Check the device and mains cable beforehand for damage.
- ◆ Should you discover damage to the equipment, please consult our customer service department (see page 88).



Incorrect use leads to an increased risk of injury.

- ◆ Train all personnel to use the RolloTron Comfort DuoFern safely.
- ◆ This device may be used by children from 8 years of age upwards as well as by persons with reduced physical, sensory or mental capacities or with lack of experience and knowledge if they are supervised or have been instructed on how to use the device safely and if they understand what dangers may result from this.
- ◆ Children must not play with the device.
- ◆ Cleaning and user maintenance may not be carried out by children without supervision.

- ◆ Watch the moving roller shutters whilst carrying out the settings and during normal operation, and keep other people away from the area to avoid injury in the event the shutters suddenly slip.
- ◆ Carry out all cleaning work on the roller shutters whilst the device is disconnected from the mains power.

The mains socket and plug must be easily accessible at all times.



Exceeding the maximum permissible running time (KB) can overload and damage the RolloTron Comfort DuoFern.

- ◆ The maximum permissible running time for a cycle may not be exceeded when the equipment is in operation. For this reason, the RolloTron Comfort DuoFern has an automatic **running time limit (KB)** of four minutes.
- ◆ If the running time limit is triggered, then the RolloTron Comfort DuoFern must be left for at least 12 minutes to cool down. Full operational availability is re-established after approx. one hour.



5. Safety instructions

EN

According to DIN EN 13659, it is necessary to determine that the movement conditions for the shutters are maintained in accordance with EN 12045.



- ◆ The displacement must amount to at least 40 mm on the lower edge in the rolled-out position with a force of 150 N in the upwards direction.
- ◆ In doing so, it must be ensured that the extending speed of the shutters for the final 0.4 m is less than 0.15 m/s.



5.1 Proper use

Only use the RolloTron Comfort DuoFern for opening and closing roller shutters with a permissible belt.



Mechanical locks of any kind are not suitable for automated operation with this device.

Only use original spare parts from RADEMACHER.

- ◆ By doing so, you avoid the risk of malfunctions and damage to your RolloTron Comfort DuoFern.
- ◆ As the manufacturer, we provide no guarantee for the use of third-party components and accept no liability for consequential damage resulting from such.
- ◆ All repairs to the RolloTron Comfort DuoFern must be undertaken by authorised customer service personnel.

Operating conditions

- ◆ Only operate the RolloTron Comfort DuoFern in dry rooms.
- ◆ A 230 V / 50 Hz power supply, together with a site-provided isolating device (fuse, MCB), must be permanently available at the installation location.
- ◆ An easily accessible 230 V / 50 Hz socket must be available at the installation site if the enclosed connecting cable with Euro plug is being used.
- ◆ The roller shutters must run up and down smoothly and should not stick.
- ◆ The mounting surface for the RolloTron Comfort DuoFern must be flat.

5.1 Proper use

- ◆ The installation and operation of the RolloTron Comfort DuoFern is only permitted for those systems and devices where a malfunction in the transmitter or receiver would not cause a danger to personnel or property or where this risk is already covered by other safety equipment.



Radio systems which transmit on the same frequency can cause interference.

5.2 Improper use

Using the RolloTron Comfort DuoFern for purposes other than previously mentioned is impermissible and is regarded as improper use.



There is a risk to life caused through short circuiting and electric shocks if the RolloTron Comfort DuoFern is used outside.

- ◆ Never install or operate the RolloTron Comfort DuoFern outside.



Improper use can lead to serious injuries or property damage.

- ◆ Never use the DuoFern radio system and its components (e.g. RolloTron Comfort DuoFern) for remote control of devices and systems with heightened safety-relevant requirements or where there is a heightened risk of accidents. This shall require additional safety equipment. Observe the respective statutory regulations for the installation of such systems.

5.3 Required expert knowledge of the installer

The electrical connection, installation and commissioning of the RolloTron Comfort DuoFern must only be carried out by a qualified electrician in accordance with the instructions in this manual.



6. Permissible roller shutter belts

ATTENTION!

The RolloTron Comfort DuoFern may be damaged if excessively long belts are used.

Only use belts of the permissible lengths.



The specifications are intended for guidance only and apply to an ideal installation situation. The actual values may vary due to local conditions.

Table 1: Permissible roller shutter belts

RolloTron:		Comfort DuoFern (Small belt)	Comfort DuoFern	Comfort DuoFern Plus
Item No:		1615 45 11	1623 45 11	1623 60 11
Belt width:	Belt thickness:	Maximum belt length		
15 mm (Small-belt)	1.0 mm	7.6 m	---	---
	1.0 mm	---	7.6 m	15 m
23 mm (Standard belt)	1.3 mm	---	6.2 m	12 m
	1.5 mm	---	5.2 m	11 m

Table 2: Permissible shutter surface area (m²)

Roller shutter type:	Weight/m²	Permissible shutter surface area (m²)		
Plastic roller shutters	(4.5 kg/m ²)	Approx. 6 m ²	Approx. 6 m ²	Approx. 10 m ²
Aluminium and wooden roller shutters	(10.0 kg/m ²)	Approx. 3 m ²	Approx. 3 m ²	Approx. 6 m ²

The RolloTron Comfort DuoFern is a roller shutter drive designed for use inside. The unit is installed as a flush-mounted device. The power supply is provided via the enclosed connecting cable with plug or a fixed installed lead.

The RolloTron Comfort DuoFern can be controlled individually on site or it can be integrated into a DuoFern network.

As soon as you integrate your RolloTron Comfort DuoFern into a DuoFern network, you can make use of many functions offered by the corresponding DuoFern controllers.

The DuoFern receivers (actuators) and transmitters must be connected to the DuoFern network.

You can find a detailed description of the various functions, configuration options and possible combinations for the DuoFern system at:

<http://www.rademacher.de/duofern>.

Central control of several DuoFern devices with a single RolloTron Comfort DuoFern.

A **DuoFern network** generally includes the **DuoFern central operating unit** or the **HomePilot®** (together with the associated user interface) as the central controllers.

Alternatively you can also use the RolloTron Comfort DuoFern as a central controller. To do so, you must configure the corresponding DuoFern mode (See page 39).

Selecting a DuoFern mode

The RolloTron Comfort DuoFern comes with three **DuoFern modes** which enable you to specify how the RolloTron behaves within the DuoFern network or local installation on-site.

The following DuoFern modes are available for selection (see page 39).

[1] = **DuoFern receiver**

[2] = **DuoFern transmitter**

[3] = **Local operation**

Soft-start / Soft-stop

The RolloTron Comfort DuoFern is equipped with a Soft-start / Soft-stop function. Gentle starting and stopping serves to protect the belt winder mechanics and the belt.

Obstacle detection

The movement of the belt is monitored. If the roller shutters hit an obstacle in the DOWN (∇) direction, the belt will stop moving and the belt winder is switched off.



Once the system has switched off, it is no longer possible to directly operate the drive in the same direction.

- ◆ Run the belt winder back in the opposite direction and remove any possible obstacle.
- ◆ Subsequently it is possible to operate the drive in the original direction again.



There is a risk of injury if the obstacle detection is not working.

- ◆ The belt must be wound on as evenly as possible to ensure safe and correct functioning of the obstacle detection function.
- ◆ Please ensure that the belt winds as straight and evenly as possible into the device during its subsequent cycle after the obstacle detection system has triggered.

Overload cut-off

The RolloTron Comfort DuoFern is equipped with an overload cut-off system.

If the drive jams in the UP (△) cycle (for example, due to ice), the belt winder will also switch off.

- ◆ Once the cause for the overload has been rectified, the drive will be fully operational in both directions.



7.2 Table 3: DuoFern network function table

			HomePilot®						
			DuoFern environmental sensor				DuoFern central operating unit		
			* WR ConfigTool with DuoFern central operating unit						
			Troll Comfort DuoFern			DuoFern standard manual transmitter			
			DuoFern wall controller						
Function	Value range	Factory setting							
1. Manual operation	Up / Stop / Down	-	●	●				●	●
2. Direct drive to a %-position	0 - 100 %	-							●
3. Manual mode on / off	on / off	Off					●	●	●
4. Timer on / off	on / off	On					●	●	●
5. Random function	-	-			●			●	●
6. Automatic dawn function	-	-			●			●	●
7. Automatic dawn function on / off	on / off	Off					●	●	●
8. Automatic dusk function	-	-			●			●	●
9. Automatic dusk function on / off	on / off	Off					●	●	●
10. Sun function	-	-			●				●
11. Automatic solar function on / off	on / off	Off					●	●	●
12. Sunshine position	0 - 100 %	50 %					●	●	●
13. Ventilation position on / off	on / off	Off					●	●	●
14. Ventilating position	1 - 99 %	80 %					●	●	●
15. Connectivity test	-	-							●

* The „WR ConfigTool“ software can be downloaded from our website at www.rademacher.de

- ◆ Display background illumination
- ◆ Operational demonstrator
- ◆ Manual operation
- ◆ Direct configuration and movement to a target position
- ◆ AUTO/MANU - switchover
- ◆ Easy configuration with menu-driven operation
- ◆ Weekly programme:
 - Weekly switching times (2 x)
 - 1 x [▲] and 1 x [▼] for (MON...SUN) [M0...S0]
 - Weekday and weekend switching times (4 x)
 - 1 x [▲] and 1 x [▼] for (MON...FRI) [M0...FR]
 - 1 x [▲] and 1 x [▼] for (SAT+SUN) [SA+S0]
 - Individual day switching times (14 x)
 - 1 x [▲] and 1 x [▼] for (MON / TUES / WED / ... SUN) [M0 / DI / MI / ... S0]
 - Activate a second switching time block, (dual switching times, see page 49).
- ◆ Automatic dusk function
 - Automatic darkness function with the Astro programme
 - Automatic darkness function with connected light sensor
- ◆ Automatic solar function (with light sensor)
- ◆ Automatic dawn function with the Astro programme
- ◆ Random function
- ◆ Ventilating position
- ◆ End point setting

- ◆ Button lock
- ◆ System settings
- ◆ Permanent storage of the settings
- ◆ Automatic summer / winter changeover
- ◆ Obstacle detection
- ◆ Overload cut-off
- ◆ Soft-start and Soft-stop

Description and configuration of the individual local functions

A precise description of the individual local functions and settings is included starting on page 25.

DuoFern settings

The settings required for operating the equipment in a DuoFern network are specified starting on page 35.

System settings

The individual device configuration is described beginning on page 65.

i 8. General assembly instructions



Poor routing of the belt can cause the belt to fail and leads to unnecessary loads on the RolloTron Comfort DuoFern.

Install the belt winder so that the belt runs as straight as possible into the device, in order to avoid unnecessary friction and wear.



Incorrect installation can lead to property damage.

Strong forces are exerted during operation of the system which require secure installation on a firm base.



In order to ensure optimal operation, the RolloTron Comfort DuoFern should not be installed near metal objects.

i 8.1 You will require the following tools

- ◆ Screwdriver
- ◆ Scissors
- ◆ Carpenter's gauge or measuring tape
- ◆ Pen

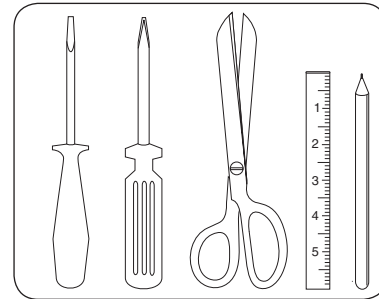



8.2 Preparation for installation

EN

1. Take measurements.

Check that the belt box has sufficient space to house the RolloTron Comfort DuoFern.

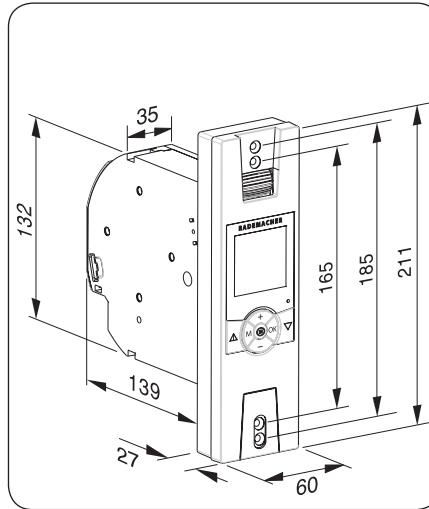

All dimensions in mm

RolloTron Comfort DuoFern

Item no.:

1615 45 11 (small belt)

1623 45 11 (standard belt)

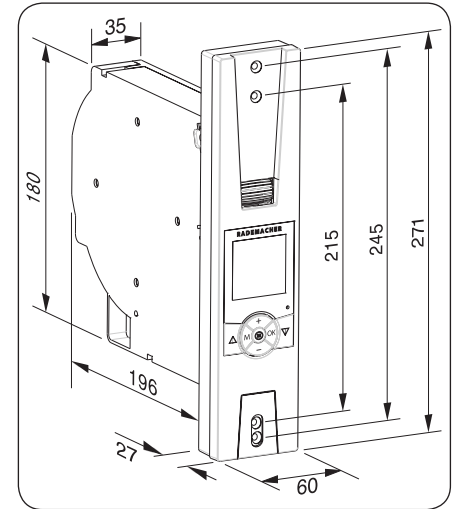

All dimensions in mm

RolloTron Comfort DuoFern Plus

Item no.:

1623 60 11 (standard belt)

2. Remove the old belt winder, if you are carrying out a conversion to an existing roller shutter system.

- 2.1 Let the roller shutter move fully down, until the slats are completely closed.

- 2.2 Remove the old belt winder and unreel the belt.

⚠ CAUTION!

There is a risk of injury from the pre-tensioned springs on the old belt winder.

- ◆ The spring unit of the old belt winder may suddenly recoil when it is removed.
- ◆ Hold the spring unit firmly when loosening the belt and allow it to recoil slowly until the spring unit has completely unwound.

3. Prepare the belt.

- 3.1 Cut the belt off approx. 20 cm under the belt box.

- 3.2 Fold the end of the belt over by approx. 2 cm and cut a short slit in the centre. This enables you to subsequently hook the belt onto the reel.

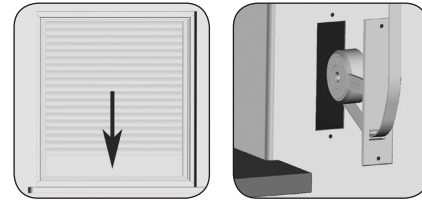

Recommendation

The belt must run as straight and freely as possible. For stiff roller shutters, mount a deflection roller on the belt box. This helps to prevent unnecessary friction and wear to the belt.

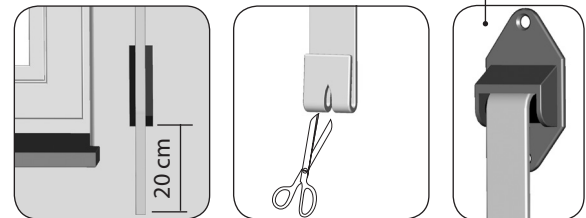

Accessories, see page 86



9. Safety instructions for electrical connection

EN



DANGER!



Danger due to electric shock when working on all electrical systems.

- ◆ Carry out all installation and connection work only in an isolated, zero-volts state.
- ◆ Disconnect all phases of the mains power supply cable and secure it to prevent any reconnection.
- ◆ Check the system for a zero-voltage status.



The electrical connection for the RolloTron Comfort DuoFern can be made either with the supplied connecting cable or via a fixed laid cable.



9.1 Electrical connection

1. Connect the provided connecting cable to the connecting terminals of the RolloTron Comfort DuoFern.
The colour coding is irrelevant for the installation.

⚠ WARNING!



A damaged connecting cable may cause a short circuit.

- ◆ Pay attention that cables are laid safely.
- ◆ The connecting cable may not be pinched when screwing on the belt winder as this could lead to damage.

2. Lay the connecting cable in the cable duct of the RolloTron Comfort DuoFern.
3. Finally, screw on the traction relief mechanism with the screws provided.

Traction relief

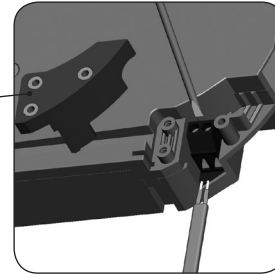

**RolloTron
Comfort DuoFern**

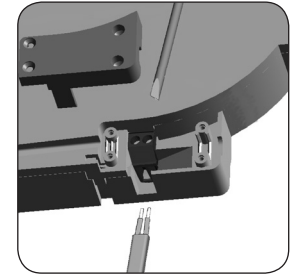

**RolloTron
Comfort DuoFern Plus**

Cable duct

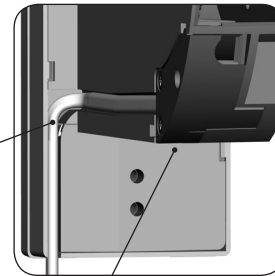

Traction relief



10. Drawing in and fastening the belt

EN

1. Insert the mains plug into the socket.

 **CAUTION!**

There is a risk of injury from the reel.

Never reach into the reel compartment when the motor is running.

2.  Press the Up button until the fastening hooks are easily accessible in the reel compartment.



As no end points have been set yet, the drive will stop as soon as you release the button.

3. Always remove the mains plug from the socket.

4. Next, draw-in the belt into the RolloTron Comfort DuoFern from the top.

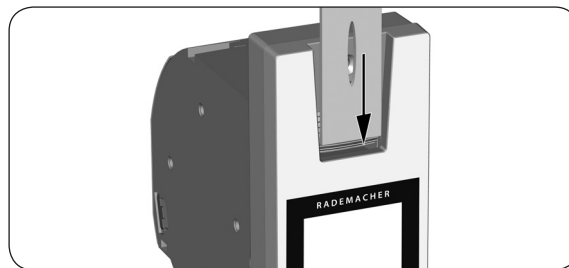
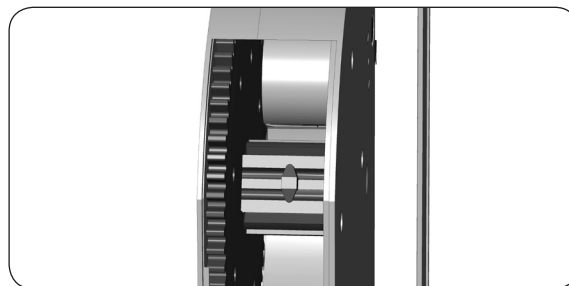



10. Drawing in and fastening the belt

5. Continue to feed the belt into the device as shown in the bottom right sectional diagram and subsequently slide the belt over the fastening hooks from above.
6. Re-insert the mains plug into the socket.
7.  Press the Up button until the belt has wound completely once around the reel.
8. Pull the belt tight when winding, so that the deflection roller turns at the same time.
9. Remove the mains plug again from the socket again.
10. Finally, place the provided reel compartment cover onto the reel compartment.

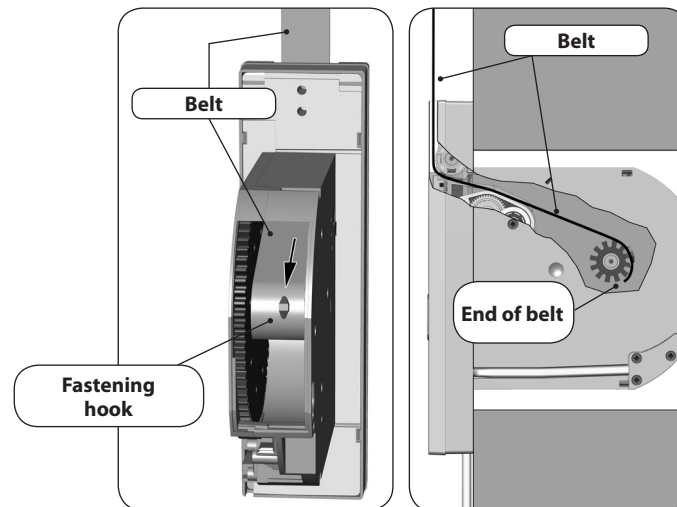

**Belt path in
RolloTron Comfort DuoFern**

Mount the RolloTron Comfort DuoFern as straight as possible, so that the belt can wind correctly.

Ensure that the RolloTron Comfort DuoFern sits freely in the belt box and that it is not in contact with the masonry, otherwise noise will be generated during operation.

1. Slide the RolloTron Comfort DuoFern into the belt box and screw it tight using the screws provided.

⚠ WARNING!



A damaged connecting cable may cause a short circuit.

Ensure that the connecting cable is laid correctly inside the cable duct, otherwise it can be crushed and damaged when the cover is screwed in place.

2. Slide the enclosed cover plate over the lower mounting holes.
3. Re-insert the mains plug into the 230 V / 50 Hz socket.

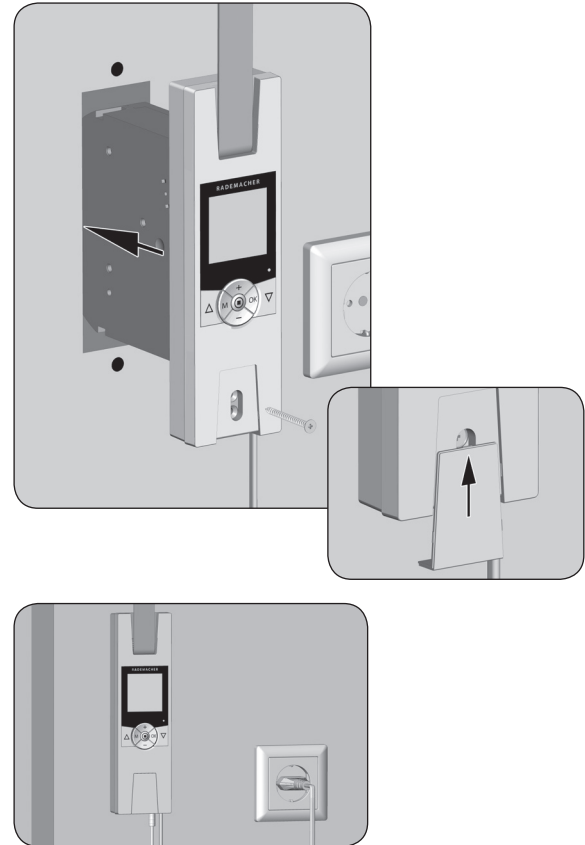



12. Brief description of the button functions



Operating buttons [Up / Down]

- ◆ Manual operation [Up▲/Down▼].



SET/Stop button, [●]

- ◆ Configuration (setting) of various functions.
- ◆ Manual roller shutter stop.



Menu button, [M]

- ◆ Call up the main menu.
- ◆ Back to previous menu or standard display.



Plus/Minus buttons

- ◆ Setting of parameters (more / less).
- ◆ Pressing one of the buttons for an extended period causes the numbers to change more quickly in the respective direction.
- ◆ Configuration and movement to a target position.



[OK] button

- ◆ Confirms and opens the selected menu.
- ◆ Confirm and save entry.
- ◆ Continue to next entry.



[Reset] button, see page 7

- ◆ Carry out a hardware reset, see page 74.

The standard display (example)

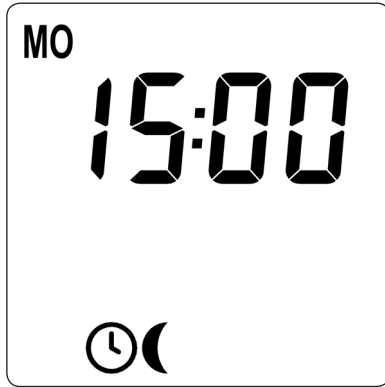

- ◆ Displays the current day of the week and time.
- ◆ Displays the activated functions.
- ◆ Manual operation of the RolloTron Comfort DuoFern is only possible from the standard display.

The main menu

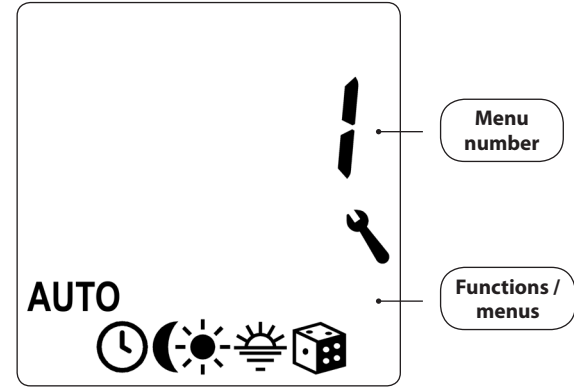

- ◆ Enables display and selection of the individual functions and menus.
- ◆ Displays the respective menu number.
- ◆ Manual operation is not possible from the main menu.
- ◆ No automatic switching commands will be executed during the configuration process.
- ◆ If no button is pressed within 120 seconds, the display automatically changes back to the standard display.

1. Call up the **main menu**.

Pressing the [M]-button in the standard display causes the main menu to open.

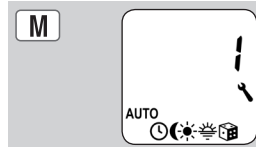

2. Select the desired menu or menu number.

The selected menu is indicated by a number and a **flashing icon**.

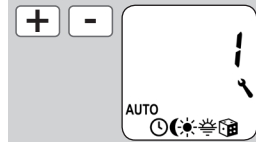

3. Open the menu by pressing the [OK] button.



4. Select the desired setting and confirm with [OK].



Example

5. Toggle back to the **standard display**.

In order to do so, press and hold the [M] button for **one second**.

Pressing the [M] button from any of the menus will return you to the **standard display**.

Briefly pressing the [M] button causes the display to go back one menu step.

If **no button is pressed** within **approx. 120 seconds**, the display changes back to the **standard display**.

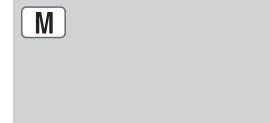
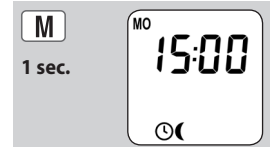



13. Initial commissioning with the help of the installation wizard

EN

An installation wizard is available in order to help you configure the RolloTron Comfort DuoFern quickly and easily. The wizard automatically guides you through the configuration process for **initial commissioning** or after a **software reset** (see page 74).

Quitting the installation wizard.

Pressing the **[M] button** for 2 seconds causes the installation wizard to be cancelled prematurely.

Readiness for operation

The RolloTron Comfort DuoFern is ready for use as soon as the installation wizard has finished.

In addition, you can individually customise your settings and make changes at any time from the main menu and the system settings menu.

Additional information about configuring the end points

The end points must be configured in order for the roller shutters to stop at the desired upper and lower positions. It is imperative that both end points are configured, otherwise malfunctions may occur.



If the RolloTron Comfort DuoFern is operated without an end point setting, the drive will continue to run for as long as one of the two control buttons is actuated.

- ◆ The automatic functions remain blocked until the end point setting is configured.
- ◆ Please ensure that the belt is not excessively slack when reaching the **lower end point**.



ATTENTION!

Setting the wrong upper end point may lead to overload or damage the RolloTron Comfort DuoFern or the drive.

- ◆ Do not set the **upper end point** right up to the limit stop.
- ◆ Release the button promptly and never allow it to extend beyond the respective end point.



After a period of time it may be necessary to reconfigure the end points as the belt may elongate during the process of operation due to stretching.



13. Initial commissioning with the help of the installation wizard

EN

1. Set the **upper end point**.

- In order to do so, press and hold the [**Up**] button.
- The roller shutters travel up.
- Release the [**Up**] button as soon as the desired upper end point has been reached.
- Correct the upper end point, if necessary.
- Store the upper end point.

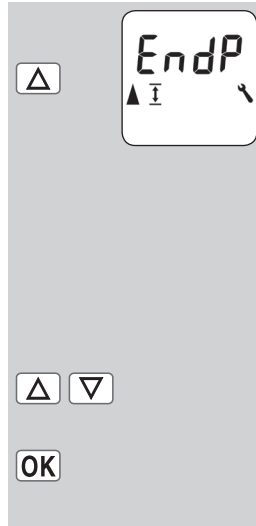

2. Set and store the **lower end point**.

Repeat points **1.a - 1.e** with the [**Down**] button.

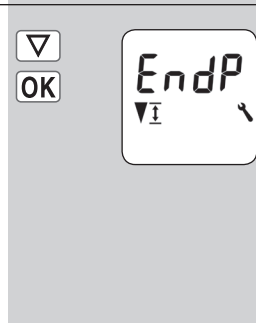

3. Set and confirm the **time**.

Pressing the plus or minus button for an extended period causes the numbers to progress more quickly.

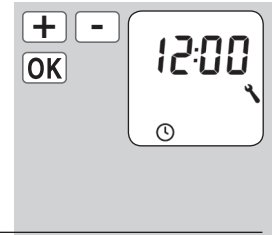

4. Set and confirm the **date** (day of the week / month).

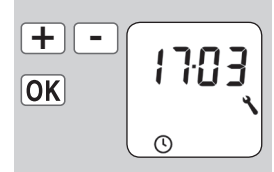

5. Set and confirm the **year**.

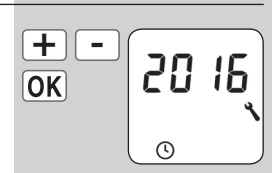

6. Set and confirm the first two digits of your **German postcode [PLZ]** or **the desired international time zone**.

Additional information is given on page 69.

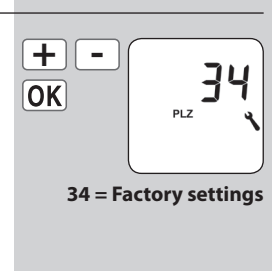

7. Set and confirm the **opening time** [▲].

This closing time mode applies to the entire week (MON...SUN) [M0...S0].

At this point, the opening time is preconfigured as the **weekly switching time** (MON...SUN) [M0...S0].

a) Configure the **switching time mode** for the **opening time** [▲].

NORMAL

The roller shutters open at the configured opening time.

ASTRO

The roller shutters open at the daily calculated dawn time.

Switching time mode >

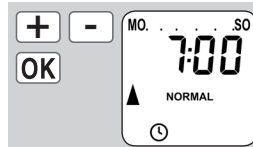

If necessary, you can subsequently select between three **switching time programmes** from the **weekly programme**, see page 70.



The previously configured opening time is interpreted as "**earliest at xx:xx hours**".

See page 50

b) If [ASTRO] is selected, then the calculated opening time for the current day is displayed.

c) Continue to set the closing time.

8. Set and confirm the **closing time** [▼].

The closing time applies to all days of the week (MON...SUN) [M0.. .S0].

At this point, the closing time is preconfigured as the **weekly switching time** (MON...SUN) [M0...S0].

a) Configure the **switching time mode** for the **closing time** [▼].

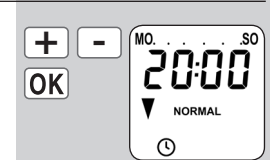
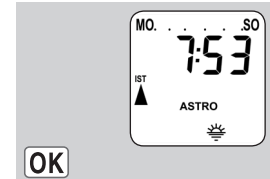

If necessary, you can subsequently select between three **switching time programmes** from the **weekly programme**, see page 70.



NORMAL

The roller shutters close at the configured closing time.

ASTRO

The roller shutters close at the daily calculated dusk time.

SENSOR

The roller shutters close every day at dusk, as measured by the light sensor.

Switching time mode >

- b) If [**ASTRO**] is selected, then the calculated closing time for the current day is displayed.
- c) Confirm the settings and return to the standard display.

The previously configured closing time is interpreted as "**latest at xx:xx hours**".

The previously configured closing time is interpreted as "**latest at xx:xx hours**".

See page 50



OK



9. The **standard display** is shown as soon as the final setting is confirmed.
The RolloTron Comfort DuoFern is now ready for operation.



14. Manual operation

Manual operation is possible in any of the modes and has priority over the programmed automatic functions.

1.  Open the roller shutters.
Briefly pressing the button causes the roller shutters to move to the upper end point.

2.  /  or  Causes the roller shutters to stop in the interim.

3.  Closing the roller shutters.
Briefly pressing the button causes the roller shutters to move to the **configured ventilation position** or to the lower **end point**.

Ventilation position, see page 68

If the ventilation position is configured, the roller shutters will first roll down to this position.

Pressing the [**Down**] button once more causes the roller shutters to continue down to the end point.

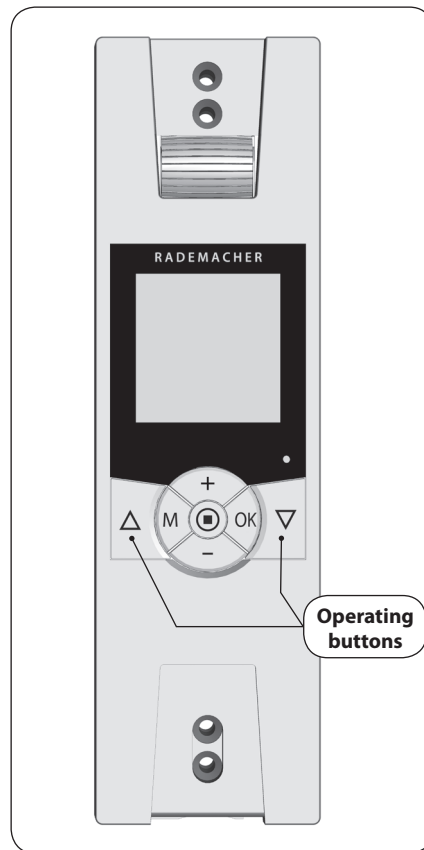

If necessary, you can enter an arbitrary **target position** for your roller shutters which you can then move to directly.

The RolloTron Comfort DuoFern is able to move to the target position and stop the roller shutters fully independently and automatically. It is not necessary to give an additional manual movement or stop command.

Target position

The target position is entered as a percentage and can be selected in 10% steps using the plus / minus buttons.

0 % = the roller shutters are fully opened.

100 % = the roller shutters are fully closed.

Automatic movement to a target position after approx. two seconds.

The system will initiate movement to the configured target position automatically if no button is pressed for approx. two seconds.



The ventilation position is ignored when moving to the target position.

1. Display the current position of the roller shutters.

a) In order to do so, briefly press the plus or the minus button.

b) The current position of the roller shutters is displayed as a percentage.

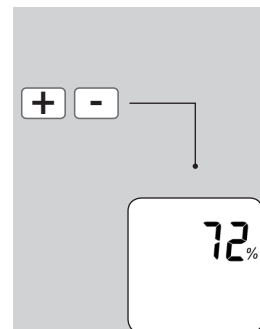

2. Enter the desired target position by repeatedly pressing the button (e.g. 50%).

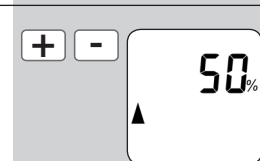

3. The RolloTron will automatically move to the target position and stop after approx. two seconds.

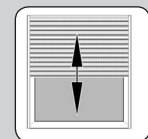



14.2 Displaying weather data

EN

If a **DuoFern environmental sensor** is being used on site, it is possible to view the **environmental sensor's** weather data on-screen.



In the event that multiple environmental sensors are in being received, the desired environmental sensor can be selected in menu **9.9.4** (see page 43).

Accessories, see page 86.

1. Accessing the **weather data**.

To do so, briefly press the **[SET / Stop]** button.

Initially, the **temperature** is displayed. An **umbrella** appears additionally on the display if the environmental sensor detects rain.

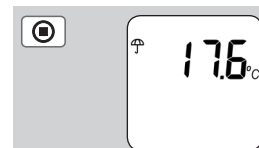

2. Pressing the plus or minus button enables all of the weather data to be accessed successively:

a) **Brightness** in kilolux **[klx]**.

b) **Wind speed** in metres per second **[m/s]**.

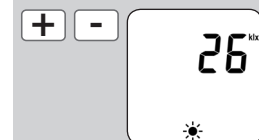

3. Back to normal view.

The weather data display closes after approx. 10 seconds if no buttons are pressed.





15. DuoFern settings; brief description

In order for your RolloTron Comfort DuoFern to react to control signals from the DuoFern network, it is necessary to log **each DuoFern device** (e.g. RolloTron Standard DuoFern, DuoFern central operating unit, etc.) on to the RolloTron Comfort DuoFern.



To do so, please read the operating instructions for the respective DuoFern device.

Maximum number of connected devices

You can assign a **maximum of 20 DuoFern devices** to a single RolloTron Comfort DuoFern.



Additional information about logging on can be obtained from the login matrix on our website under: www.rademacher.de

The following section serves to describe all required **DuoFern Settings** for the RolloTron Comfort DuoFern.

The **DuoFern Settings** immediately affect the subsequent automatic function settings and the integration of the RolloTron Comfort DuoFern into the DuoFern network.

Menu 9.9 - DuoFern Settings

The DuoFern settings are undertaken in **menu 9.9**. You can find an overview of all menus and sub-menus for the RolloTron Comfort DuoFern on pages 45 and 65.



Menu 9 - System settings

Icon	Menu	Page
	9.9 DuoFern settings	35
	9.9.1 Logging on and off	36
	9.9.2 Setting the DuoFern mode	39
	9.9.3 Setting the solar mode	41
	9.9.4 Switching weather data on/off	43
	9.9.5 Display DuoFern address	44



15.1 Menu 9.9.1 - Logging DuoFern devices on/off

EN

1. Select and open menu **9.9.1 Log-on/off.**

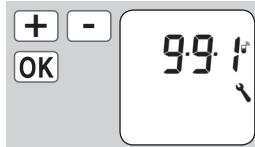

2. The number of logged on DuoFern devices is indicated on the display.

Example:

05 = there are five DuoFern devices logged on.



3. Select the **desired mode.**

On = Activate login mode

OFF = Deactivate login mode



3.1 [On] Registration mode

a) The display flashes **[On]**.

b) Login mode remains active for approx. **120 seconds.**

c) Switch the desired DuoFern device to login mode.

d) The **new number** of logged-on devices is displayed after successful login (e.g. 06).

The RolloTron starts up briefly by way of confirmation.

e) Log-in the next DuoFern device.

or

f) Back to menu selection.



Approx. 120 seconds



+

OK





15.1 Menu 9.9.1 - Logging DuoFern devices on/off

3.2 [OFF] Logout mode

- a) The display flashes [OFF].
- b) Logout mode remains active for approx. **120 seconds**.
- c) Switch the desired DuoFern device to logout mode.
- d) The **new number** of logged-on devices is displayed after successful logout (e.g. 04).
The RolloTron starts up briefly by way of confirmation.
- e) Log-out the next DuoFern device.
or
- f) Back to menu selection.

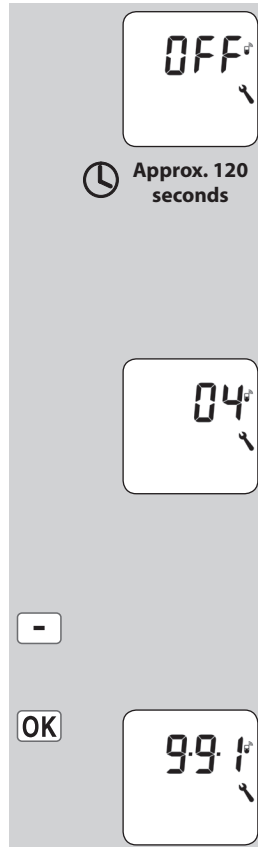

Deleting all logged-on DuoFern devices.

1. Select and open menu 9.9.1 [Log-on/off].
2. The number of logged on DuoFern devices is indicated on the display.
3. **Delete** all of the registered DuoFern devices.
To do so, press the minus button for approx. four seconds, [OFF] flashes on the display.
4. Subsequently, all DuoFern devices will be deleted.
5. Back to menu selection.

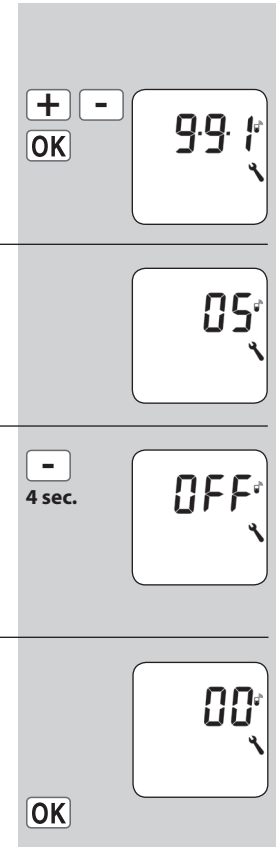



15.1 Menu 9.9.1 - Logging DuoFern devices on/off

Clearing the DuoFern network.

This function enables you to log off all DuoFern devices from the RolloTron Comfort DuoFern that are no longer accessible via radio.



All battery-operated DuoFern transmitters (e.g. the DuoFern central operating unit) cannot be logged off via this function.

1. Select and open menu **9.9.1 Log-on/off.**

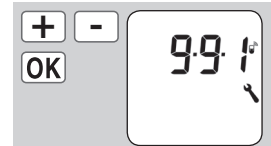

2. The number of logged on DuoFern devices is indicated on the display.



3. Activate the **clear** function.
In order to do so, press and hold the [**SET/Stop**] button for approx. four seconds.



4. Subsequently, all currently registered DuoFern devices will be displayed (e.g. 02).



5. Back to menu selection.





15.2 Menu 9.9.2 - Set DuoFern mode

The RolloTron Comfort DuoFern comes with three **DuoFern modes** which enable you to specify how the RolloTron behaves within the DuoFern network or local installation on-site.

The following DuoFern modes are available for selection:

- [1] = **DuoFern receiver**
- [2] = **DuoFern transmitter**
- [3] = **Local operation**

[1] DuoFern receiver

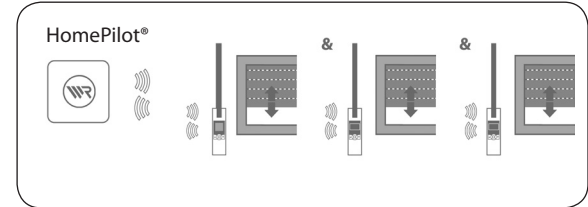

- ◆ The RolloTron Comfort DuoFern is integrated into a **central automatic** DuoFern network as **[receiver]** (e.g. via a DuoFern central operating unit or HomePilot®, etc.).
- ◆ In addition, it can be remotely controlled by other DuoFern devices (e.g. a DuoFern manual transmitter).

Function

- ◆ **Not** all local timer periods and automatic functions are available to the RolloTron Comfort DuoFern in mode [1].
- ◆ The controls and functions are realised in the same manner as for all DuoFern receivers (actuators).



15.2 Menu 9.9.2 - Set DuoFern mode

[2] DuoFern transmitter

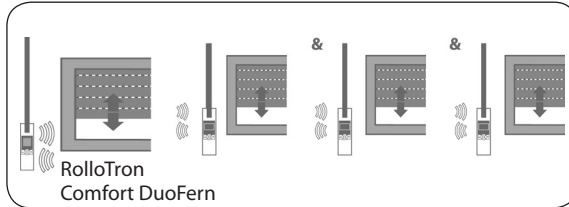

- ◆ The RolloTron Comfort DuoFern is integrated into a DuoFern network as a **central controller [Sender]** and is intended to provide automatic functions for other DuoFern receivers.
- ◆ The image shows an **example** of a **central controller for several RolloTron Standard DuoFern** devices via a RolloTron Comfort DuoFern.

Function

- ◆ The timer periods and automatic functions configured on the RolloTron Comfort DuoFern are available in mode [2].
- ◆ The configured timer periods and automatic functions on the RolloTron Comfort DuoFern will be transmitted to all registered DuoFern receivers and will be executed by the respective devices.

[3] Local operation (factory setting)

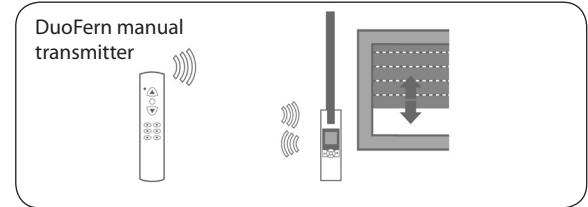

- ◆ The RolloTron Comfort DuoFern is operated as a local roller shutter belt winder using its automatic functions and timer durations.
- ◆ In addition, control commands can also be received and executed from the DuoFern network (e.g. from a DuoFern manual transmitter).

Function

- ◆ The timer periods and automatic functions configured on the RolloTron Comfort DuoFern are only executed by the local RolloTron device itself in mode [3].
- ◆ The timer durations and automatic functions are **not** transmitted to other DuoFern receivers.



15.2 Menu 9.9.2 - Set DuoFern mode

1. Select and open menu **9.9.2 DuoFern mode.**



2. Select and confirm the **mode.**

- 1 = DuoFern receiver
- 2 = DuoFern transmitter
- 3 = Local operation



Regardless of the set mode, all manual and automatic control signals received via radio will be executed locally.

With one exception:

Control commands for the automated solar functions will only be accepted if the solar mode [3] is activated (see next chapter).



15.3 Menu 9.9.3 - Setting the solar mode

This function enables you to determine how the RolloTron Comfort DuoFern reacts to signals from a locally connected light sensor or control commands from a central sun shading controller (e.g. a DuoFern radio sun sensor).

The subsequent configuration of the automated solar functions is correspondingly influenced by the selection of the solar mode.

The following solar modes can be selected:

- [1] = **Local light sensor**
- [2] = **Local light sensor and sunshine position**
- [3] = **Central sun shading controller**



15.3 Menu 9.9.3 - Setting the solar mode

[1] Local light sensor *

Select mode [1] if ...

- ◆ ...the RolloTron Comfort DuoFern is to be controlled by a light sensor connected to this device.

Functions and settings for the automated solar function:

- ◆ The roller shutters close to the position of the light sensor on the window.
- ◆ The solar limit value must be set.
- ◆ Mount the light sensor on the window at the position to which the roller shutters should lower when the sun shines.

[2] Local light sensor and sunshine position *

Select mode [2] if ...

- ◆ ...the RolloTron Comfort DuoFern and other registered DuoFern devices (e.g. RolloTron Standard DuoFern) are to be controlled by a light sensor connected to this device.
- ◆ ... every device (and every roller shutter) is to be stopped at an individually configured sunshine position.

Functions and settings for the automated solar function:

- ◆ All roller shutters close to the configured sunshine position.
- ◆ The solar limit value must be set.

- ◆ The desired sunshine position must be set on the RolloTron Comfort DuoFern and the other DuoFern devices. **
- ◆ Mount the light sensor as low as possible on the window so that it cannot be covered by the roller shutters.

[3] Central sun shading controller

Select mode [3] if ...

- ◆ ...the RolloTron Comfort DuoFern and other registered DuoFern devices are to be controlled by a **central sun shading controller**.

Functions and settings for the automated solar function:

- ◆ All roller shutters close to the configured sunshine position.
- ◆ The desired sunshine position must be set on the RolloTron Comfort DuoFern and the other DuoFern devices. **

* **No signals** are executed from a central sun shading controller in modes [1] and [2].

** Please read the operating manual for the respective DuoFern devices to configure the sunshine position.



15.3 Menu 9.9.3 - Setting the solar mode

1. Select and open menu **9.9.3 solar mode.**

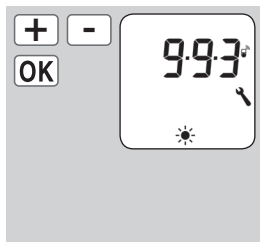

2. Select and confirm the **solar mode.**

- 1 = Local light sensor
- 2 = Local light sensor and sunshine position
- 3 = Central sun shading controller

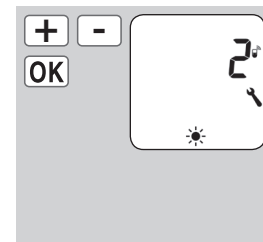

15.4 Menu 9.9.4 - Switch weather data on/off

This menu enables you to switch the weather data display on and off.

If numerous environmental sensors are being received, then you can additionally select the desired environmental sensor.



Environmental sensors update the weather data approx. every 5 minutes. For this reason, it can take a few minutes until the weather data is displayed.

1. Select and open menu **9.9.4 weather data.**

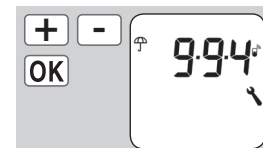

2. Switch weather data display ...

On = ... on *

OFF = ... off

* Continue at 3.

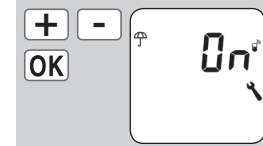



15.4 Menu 9.9.4 - Switch weather data on/off

3. The DuoFern address of the environmental sensor is displayed.



4. Select and confirm the desired environmental sensor.



The environmental sensors can be deleted if necessary.

Briefly press the [SET/Stop] button.

This display is shown by way of acknowledgement.

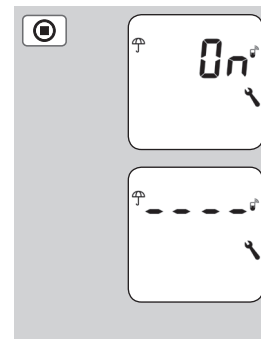

15.5 Menu 9.9.5 - Display DuoFern address

Each DuoFern device has its own unique **address** via which it communicates on the DuoFern network.

If necessary, you can display the **DuoFern address** for the RolloTron Comfort DuoFern device.

1. Select and open menu **9.9.5 DuoFern address**.
 - a) In each case, two digits of the six-digit address are shown in the form of a ticker.

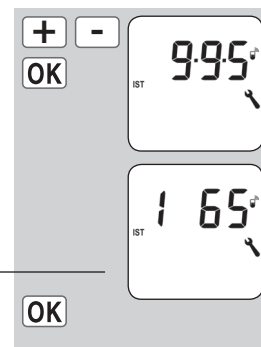

2. Back to menu selection.



Standardised menu structure

A standardised, cross-product menu structure has been developed for all RADEMACHER devices. Similar functions always have the same menu number and therefore there may be gaps in the numbering.



Main menu

Icon	Menu	Page
AUTO	1 Automatic mode	46
	2 Switching times.....	48
	3 Automatic dusk control	55
	4 Automatic solar function	58
	5 Automatic dawn control.....	62
	6 Random function	64
	9 System settings	65



16.1 [AUTO] Automatic mode; brief description

EN

Automatic mode on

Icon in standard display

Automatic mode is active, all automatic functions are switched on, e.g.:



Timer periods



Weekly programme



Automatic dawn function



Automatic dusk function



Automated solar function



Random function



Manual operation is also possible in automatic mode.

Automatic mode off



Icon in standard display

- ◆ All automatic functions are deactivated; only manual operation is possible.
- ◆ All automatic icons are switched off in the standard display.

1. Call up the main menu.



2. Select and open menu 1 [AUTO].

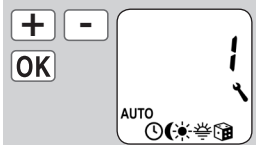

3. Select and confirm the desired setting.

On = Automatic mode on
OFF = Automatic mode off



4. The main menu appears again once this is confirmed.

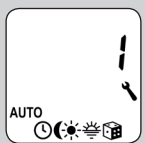

OK Toggling directly to the standard display

You can also directly toggle automatic mode on and off in the standard display.

1. To do so, press and hold [OK] for approx. one second in the standard display.



Automatic mode on



Automatic mode off



16.2 Switching times (opening and closing times) [▲/▼]; brief description

EN

You can configure various **opening [▲] and closing times [▼]** in order to open or close your roller shutters at your preferred times.

Determining the mode of operation and number of opening [▲] and closing times [▼]:

The mode of operation and the number of opening and closing times that can be configured depends on the desired **switching programme**.

You can choose between three switching time programmes in Menu 9.5 [🔑] weekly programme, see page 70:

[1] **Weekly switching times**

[2] **Working day and weekend switching times**

[3] **Individual day switching times**

[1] Weekly switching times

You can set two different switching times here:

1 x opening time [▲] and 1 x closing time [▼] valid from Monday to Sunday (MO...SUN) [MO to SO].

[2] Working day and weekend switching times

You can set four different switching times here:

1 x opening time [▲] and 1 x closing time [▼] valid from Monday to Friday (MO ... FRI) [MO to FR].

1 x opening time [▲] and 1 x closing time [▼] valid for Saturday and Sunday (SAT...SUN) [SA..SO].

[3] Individual day switching times

You can set 14 different switching times here.

1 x opening time [▲] and 1 x closing time [▼] for each individual day of the week (MON + TUES, + ...SUN) [MO + DI + ...SO].

Changing the switching times

You can change the switching time settings at any time.



16.2 Switching times (opening and closing times) [▲/▼]; brief description

Double the amount of switching times by activating a second switching time block:

If necessary you can double the amount of available opening and closing times. In order to do so, a **second switching time block (n = 2)** must be activated in the **weekly programme**, see page 70.

Assigning opening and closing times to a second switching time block.

If a **second switching time block** has been activated, you can select it prior to setting the opening and closing times.



The switching times in the second switching time block [2] can **not** be linked to a **switching time mode** [NORMAL / ASTRO / SENSOR].

Application example for a second switching time.

You can use a second switching time, for example, to darken a child's bedroom at midday:

- The **first opening time** has been set to 8:00 a.m.
- The roller shutters will open at 8:00 a.m.
- The roller shutters should close again at 12:00 noon and open again at 14:30 hours.
- In order to do so, a **second switching time block** must be selected and the respective **second opening and closing time** must be set.
- The **first closing time** was set to 20:00 hours.
- The roller shutters close at 20:00 hours.



16.2 Switching times (opening and closing times) [▲/▼]; brief description

EN

Selecting a switching time mode.

A switching time mode can be selected during the settings for **the first** opening and closing times.

The following switching time modes are possible:

- ◆ **NORMAL**
- ◆ **ASTRO**
- ◆ **SENSOR**

Brief description of the switching time modes.

◆ **NORMAL**

The roller shutters open at the configured opening time and close at the configured closing time.

◆ **ASTRO**

Calculation of the respective switching time by means of an "Astro" programme.

The opening and closing times are calculated in relation to the date and postcode. Subsequently they are linked to the previously configured switching times.

● **Link to the opening time [▲]**

The roller shutters open at the daily calculated dawn time. The configured **opening time** is interpreted as "**earliest at xx:xx hours**".

● **Example a:**

- Dawn begins at 5:00 a.m.
- The opening time has been set to 7:00 a.m.
- Your roller shutters will open at 7:00 a.m.

● **Example b:**

- Dawn begins at 08:00 a.m.
- The opening time has been set to 7:00 a.m.
- Your roller shutters will open at 08:00 a.m.

● **Link to the closing time [▼]**

The roller shutters close at the daily calculated dusk time. The previously configured **closing time** is interpreted as "**latest at xx:xx hours**".

● **Example a:**

- Dusk begins at 17:00 hours.
- The closing time has been set to 20:00 hours.
- Your roller shutters will close at 17:00 hours.

● **Example b:**

- Dusk begins at 22:00 hours.
- The closing time has been set to 20:00 hours.
- Your roller shutters will close at 20:00 hours.



16.2 Switching times (opening and closing times) [▲/▼]; brief description

◆ SENSOR (only for closing times [▼])

The closing time is controlled by a light sensor in relation to the level of brightness.

In addition, the measured twilight value is linked to the previously configured closing time. The configured closing time is interpreted as "latest at xx:xx hours".

● Example a:

- In winter dusk begins, for example, at approx. 17:00 hours.
- The closing time has been set to 20:00 hours.
- Your roller shutters will close at 17:00 hours.

● Example b:

- In summer dusk begins, for example, at approx. 22:00 hours.
- The closing time has been set to 20:00 hours.
- Your roller shutters will close at 20:00 hours.



16.2.1 Menu 2 - Configuration of opening and closing times [▲/▼]

1. Call up the main menu.



2. Select and open menu 2 [☉] **Switching times.**

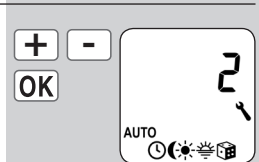

3. Activate and confirm the switching times.
On = Switching times on
OFF = Switching times off

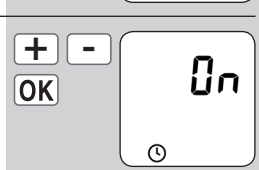

4. Select and confirm a **switching time block.**

If the function is not activated, proceed at **point 5.**

- 1 = The switching time setting is realised with a **switching time mode.**
- 2 = The switching time setting is realised **without a switching time mode.**

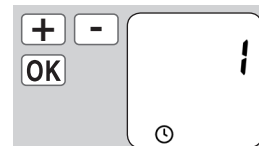



16.2.1 Menu 2 - Configuration of opening and closing times [▲/▼]



The **mode of operation** and the **number** of opening and closing times that can be configured depends on the desired **switching programme**, see page 48.

The header of the display indicates which switching programme is currently active (see example to the right).

This also applies to the **closing times**.

The settings for the **opening** and **closing times** [▲/▼] are identical for all **switching programmes**.

The following serves to describe the procedure for setting an **opening and closing time** [▲/▼] as a **weekly switching time**.

Weekly switching times

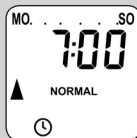

Working day / weekend switching times



Individual day switching times

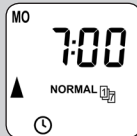

5. Set and confirm an **opening time** [▲].

a) Configure the **switching time mode** for the **opening time** [▲].

NORMAL

The roller shutters open at the configured opening time.

ASTRO

The roller shutters open at the daily calculated dawn time.

Switching time mode >

b) If [ASTRO] is selected, then the calculated opening time for the current day is displayed.

c) Continue to set the closing time.

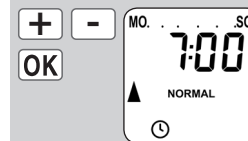

The previously configured opening time is interpreted as "**earliest at xx:xx hours**".

See page 50





16.2.1 Menu 2 - Configuration of opening and closing times [▲/▼]

6. Set and confirm the **closing time** [▼].

The closing time applies to all days of the week (Mon... Sun) [MO... SO].

a) Configure the **switching time mode** for the **closing time** [▼].

NORMAL

The roller shutters close at the configured closing time.

ASTRO

The roller shutters close at the daily calculated dusk time.

SENSOR

The roller shutters close every day at dusk, as measured by the light sensor.

Switching time mode >

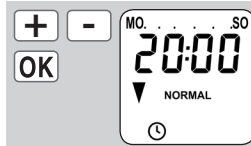

The previously configured closing time is interpreted as "**latest at xx:xx hours**".

The previously configured closing time is interpreted as "**latest at xx:xx hours**".

See page 50

b) If [ASTRO] is selected, then the calculated closing time for the current day is displayed.

c) Return to main menu.

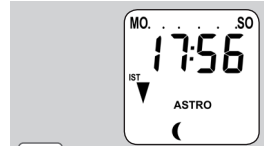

7. Select the **second switching block**, see page 51.

Only if this function has been activated in **weekly programme** with (n = 2).

> **Otherwise continue at point 10.**

a) Open **menu 2** again.



b) Confirm [On].



c) Select and confirm the **second switching block** [2].

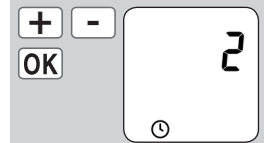



16.2.1 Menu 2 - Configuration of opening and closing times [▲/▼]

EN

8. Set and confirm the **second opening time** [▲].
OFF = The opening time is deactivated.

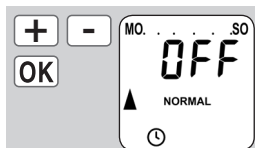

9. Set and confirm the **second closing time** [▼].
OFF = The closing time is deactivated.

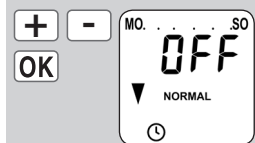

The **number** of opening and closing times that can be configured also depends on the selected **switching programme**, see page 48.

10. Return to standard display after making the final setting.



INFORMATION ABOUT THE [ASTRO] SWITCHING TIME MODE

- ◆ If [ASTRO] is selected as the switching time mode, the calculated darkness time can be individually customised by means of an offset between **-60** and **+60 minutes**. This can be configured in **menu 3**, see page 56.

INFORMATION ABOUT THE [SENSOR] SWITCHING TIME MODE

- ◆ If [SENSOR] is selected as the switching time mode, then the desired **twilight limit** value can be configured in **menu 3**, see page 57.

16.3 Automatic dusk function; brief description

The automatic dusk function causes the roller shutters to close automatically to the lower end point or configured ventilation position.

You can choose between two automatic dusk functions:

- ◆ Automatic dusk function with Astro programme = switching time mode [**ASTRO**]
- ◆ Automatic dusk function with light sensor = switching time mode [**SENSOR**]

Automatic dusk function with Astro programme

The twilight time is recalculated every day based on the geographical location and the current date (defined by the configured postcode).

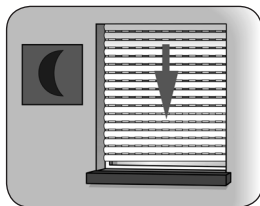

Configure a custom offset period

An offset can be configured between **-60** and **+60 minutes** in order to customise the calculated dusk time to your personal preferences. This means that it is not necessary to continuously readjust the closing time throughout the year.

A light sensor is not used for this function.

Automatic dusk function with connected light sensor

At twilight, the roller shutters will lower to the lower end limit or configured ventilation position after approx. 10 seconds. The roller shutters will open again once the configured opening time is reached or in the event of a manual command.

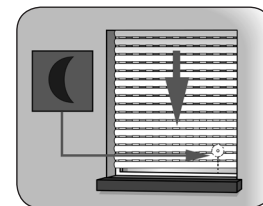

The required twilight limit is configurable.



The automatic dusk function via light sensor is only executed once per day.

Mounting the light sensor
(see page 58, Automatic solar function)



16.3.1 Menu 3 - Customising the automatic dusk function []

1. Call up the main menu.



2. Select and open menu 3 []
Automatic dusk function.



3. Select the desired switching time mode to adjust the automatic dusk control depending on the selected switching time mode.

Switch time mode, see page 50.



- ◆ NORMAL
- ◆ ASTRO
- ◆ SENSOR

3.1 [NORMAL]

No customisation is possible in [NORMAL] switch time mode.

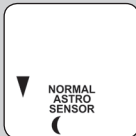

a) Return to main menu.



3.2 [ASTRO]

Setting an offset.

The offset function can be used to modify the calculated Astro time by **+/- 60 minutes.**

Example

With a negative offset e.g. "- 10", the calculated Astro time is triggered 10 minutes earlier.

a) Subsequently the resulting closing time is displayed.

b) Return to main menu.





3.3 [SENSOR]

Customisation of the **twilight limit value** in switch time mode [SENSOR].

If the set limit value is not met due to the onset of twilight, the roller shutters will close.

ACTUAL [IST] value

Currently measured brightness (e.g. 12).
"22" = too bright

SET [SOLL] value

Configurable set limit

01 = very dark,
approx. 4 Lux

15 = less dark,
approx. 40 Lux

a) Return to main menu.

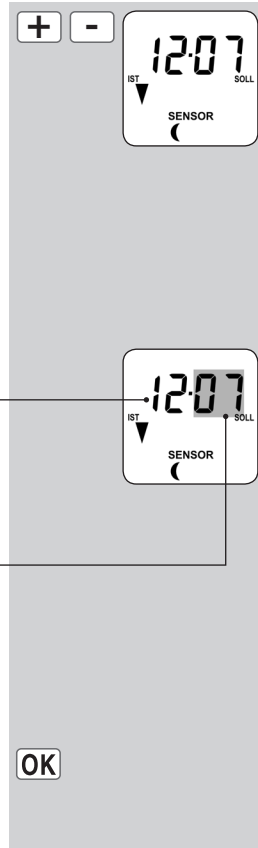



16.4 Automatic solar function; brief description

EN

The automatic solar function enables brightness-dependent control of the roller shutters in combination with the light sensor. To do this, the light sensor is secured to the window pane with a sucker and then plugged into the RolloTron Comfort DuoFern device.

or

A **central sun shading controller** is used to transmit the required signals to the RolloTron Comfort DuoFern as well as to the other devices on the DuoFern network.

Automatic solar function

Automatic moving up and down of the roller shutter once a set limit is exceeded. The roller shutter end position can be freely selected by changing the position of the light sensor on the window pane or by setting the sunshine position.



Please note the state of the sun icon on the standard display.

On

The automatic solar function is switched on.

Flashing

During the activated automated solar function, the corresponding icon flashes in the standard display as soon as sunlight is detected.

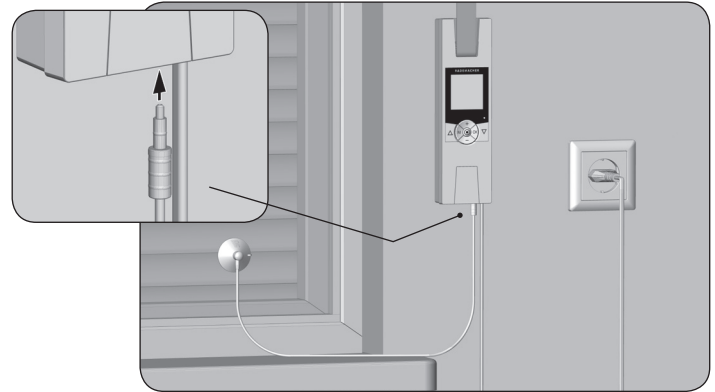

Example installation

Light sensor, see page 86 (accessories)



16.4 Automatic solar function; brief description

Automatic lowering

If the sensor detects uninterrupted sunlight for 10 minutes, the roller shutter lowers in

- ◆ **solar mode [1]**
until its shadow covers the light sensor.
- ◆ **solar modes [2] and [3]**
to the configured sunshine position.

Automatic clearing in solar mode [1]

After approx. 20 minutes, the roller shutter is automatically raised a small amount to uncover the light sensor. If the sun continues to shine, then the roller shutter remains in this position.

Automatic opening in solar modes [1] to [3]

If the brightness decreases below the configured solar limit value, the roller shutters will return to the upper end point.



The above mentioned delay times can be exceeded in the event of changing weather conditions.

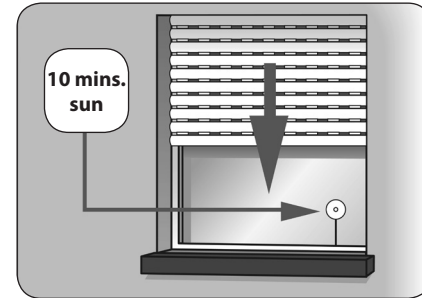

Examples of a locally mounted sun sensor.

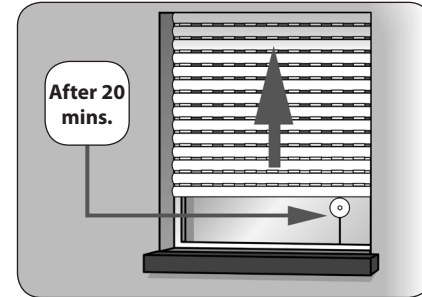

The automated solar function will be terminated and must be reactivated if required after the following events:

- ◆ After manual actuation.
- ◆ After execution of an automatic function.
- ◆ After the upper end point is reached.



16.4.1 Menu 4 - Configuring the automatic solar function [☀] and sunshine position EN

1. Call up the main menu.	
2. Select and open menu 4 [☀] Automatic solar function.	
3. Activate and confirm the automatic solar function. On = automated solar function on Off = automated solar function off	
Depending on solar mode (see page 41)...	...the following settings are required:
[1] Local light sensor	Continue at point 4
[2] Local light sensor and sunshine position	Continue at points 4 and 5.
[3] Central sun shading controller	Continue at point 5

4. Customisation of the **local solar set limit.**

ACTUAL [IST] value

Currently measured brightness (e.g. 35).
"22" = too dark

SET [SOLL] value

Configurable set limit
31 = minimal sun, approx. 4000 Lux
45 = bright sunlight approx. 40000 Lux

a) Return to main menu or continue at point 5.

OK



16.4.1 Menu 4 - Configuring the automatic solar function [☀] and sunshine position

EN

The local sunshine position

You can set an arbitrary **sunshine position** for your Rol-loTron Comfort DuoFern which your roller shutters will lower to when the automated solar function is activated.

Regarding sunshine position in solar mode [2]

- ◆ The locally mounted light sensor may not be covered by the roller shutters when they are moving downwards.
- ◆ Set the sunshine position in a way that the roller shutters remain above the light sensor. Otherwise the light sensor cannot correctly measure the brightness level.

5. Set the **local sunshine position**.

- a) Move the roller shutters to the desired position.

or

- b) Enter the desired sunshine position by modifying the percentage value.

0 % = the roller shutters are fully opened.

100 % = the roller shutters are fully closed.

- c) Confirm the sunshine position and return to the main menu.

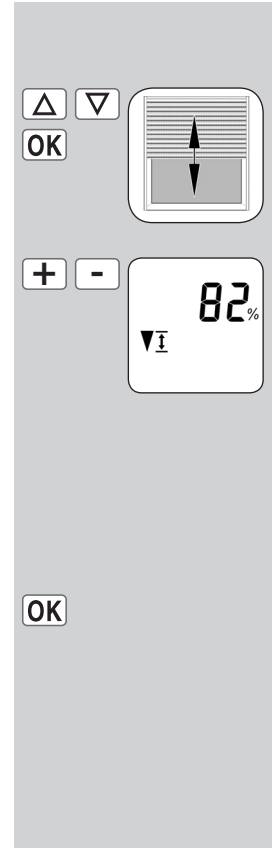



When configuring opening times [▲] it is possible to link them to a switch time mode, see page 51.

The calculated dawn time can be customised by linking the opening times with the [ASTRO] switch time mode.

Link to the opening time [▲]

The previously configured **opening time** is interpreted as "**earliest at xx:xx hours**".

Configure a custom offset period

The calculated dawn time can be customised to personal preferences by means of an offset between **-60 and +60 minutes**. This means that it is not necessary to continuously readjust the closing time throughout the year.

Application example for the [ASTRO] switch time mode, see page 50.



16.5.1 Menu 5 - Customising the automatic dawn time [☀]

1. Call up the main menu.



2. Select and open menu 5 [☀] **Automatic dawn function.**

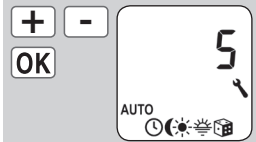

3. Select the desired switching time mode to adjust the automatic dawn control depending on the selected switching time mode.

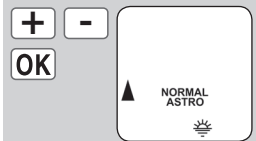

Switch time mode, see page 50.

3.1 [NORMAL]

No customisation is possible in [NORMAL] switch time mode.



- a) Return to main menu.



3.2 [ASTRO]

Setting an offset.

The offset function can be used to modify the calculated Astro time by **+/- 60 minutes.**

- a) Subsequently, the resulting closing time is displayed.

- b) Return to main menu.

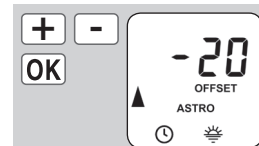



16.6 Random function; brief description

EN

The random function enables a random delay of the set timer periods ranging between 0 and 30 minutes.

The random function is executed for:

- ◆ all automatic opening and closing times.
- ◆ All switch times realised by the automatic darkness function via the Astro programme.

The random function is not executed for:

- ◆ manual movement commands
- ◆ Automatic movement commands triggered by sunlight and the automatic dusk control, if triggered by light control.



The corresponding icon flashes in the standard display when the random function is activated, during the period that the movement command is being delayed.



16.6.1 Menu 6 - Configuring the random function [🎲]

1. Call up the main menu.

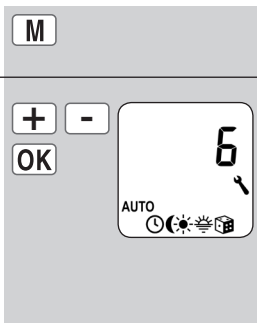

2. Select and open menu 6 [🎲] **Random function.**

3. Select and confirm the desired setting.

On = random function on

OFF = random function off

- a) Subsequently the main menu will be displayed again.

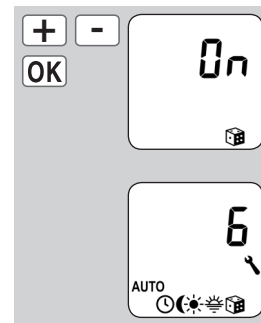









16.7 Menu 9 - System settings []; brief description

This menu enables you to configure additional device and system settings in order to customise your RolloTron Comfort DuoFern to your individual preferences and local conditions.

The procedure for opening and configuring a menu has previously been described on page 27. For this reason, the following section serves to describe the individual system menus and their respective parameters.



Menu 9 - System settings

Icon	Menu	Page
 / PLZ	9.1 Time /date / postcode.....	66
	9.2 End points	67
	9.3 Ventilation position.....	68
-	9.4 Display lighting	69
	9.5 Weekly programme	70
-	9.6 Motor speed.....	71
	9.7 Button lock.....	72
-	9.8 not used	
	9.9 DuoFern settings	35
	9.9.1 - 9.9.5	



16.7.1 Menu 9.1 - Set time / date [🕒] and Postcode [PLZ]

EN

1. Select and open menu 9.1 [🕒] Time /date and postcode.

Setting order

a) Time

b) Date [Day.Month]

c) Year

d) Postcode [PLZ]

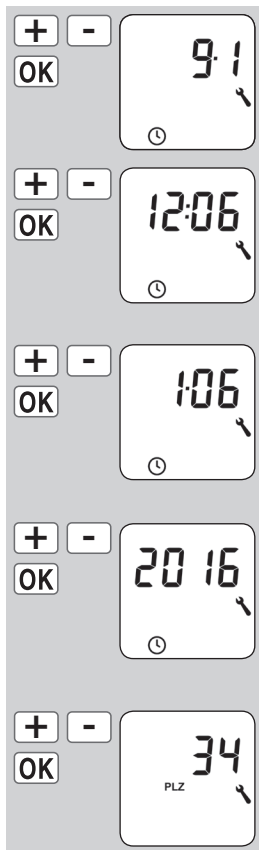

Additional information about postcode

Only the first two digits of the code are entered for German cities.

Please refer to the time zone table on page 85 for various European cities.



16.7.2 Menu 9.2 - End point configuration []

Additional information about configuring the end points

The end points must be configured in order for the roller shutters to stop at the desired upper and lower positions. It is imperative that both end points are configured, otherwise malfunctions may occur..

Observe the safety instructions for setting the end points on page 28.

1. First move the blinds manually to the centre position.

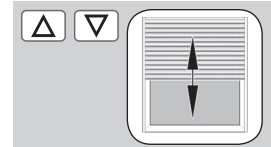

2. Select and open menu 9.2 [] End points.

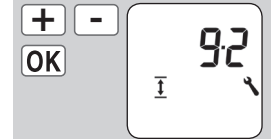

Setting order

- a) Set the upper end point, see page 28.

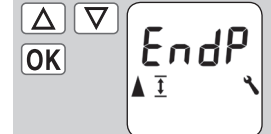

- b) Set the lower end point, see page 28.

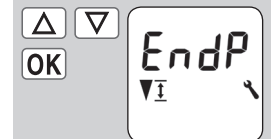



16.7.3 Menu 9.3 - Configure ventilation position [▼ ▮]

EN

If you want your roller shutters to close at a different position to the lower end point, you can use this function to determine an arbitrary position (e.g. as a ventilation position).

When closing automatically, the roller shutters will stop at the ventilation position, however, they can subsequently be closed completely via manual operation.

1. Select and open menu **9.3 [▼ ▮]Ventilation position.**

Setting order

- a) Activate or deactivate the ventilation position.

On = Ventilation position on

OFF = Ventilation position off

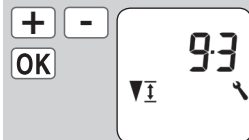

> continue at b)

> Return to menu
System settings

- b) Move the roller shutters to the desired position.

or

- c) Enter the desired ventilation position by modifying the percentage value.

0 % = the roller shutters are fully opened

100 % = the roller shutters are fully closed

- d) Confirm the ventilation position and return to the system settings menu.





16.7.4 Menu 9.4 - Configure continuous display lighting

Pressing one of the operating buttons causes the backlighting in the standard display to switch on at full intensity. Subsequently the brightness gradually fades down to the configured level.

1. Select and open menu **9.4 Display lighting**.

- a) Configure and confirm the desired brightness.

- 0** = Display lighting for the continuous display is switched off.
- 1-3** = Brightness levels
- 3** = Maximum brightness

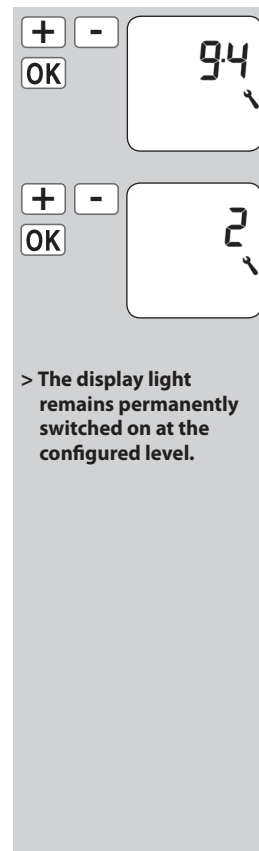

+

-

OK

94

+

-

OK

2

> The display light remains permanently switched on at the configured level.



16.7.5 Menu 9.5 - Weekly programme [] configuration

EN

The subsequent mode of operation and the number of opening and closing times that can be configured depends on the desired **switching programme**.

You can choose from three different switch time programmes in the weekly programme.

[1] Weekly switching times

[2] Working day and weekend switching times

[3] Individual day switching times

Modes of operation for the switch time programmes

The modes of operation for the switch time programmes is explained on page 48. The procedure for configuring the switching times is described starting on page 51.

Double the amount of switching times by activating a second switching time block:

If you want to double the number of configurable opening and closing times, then you must activate a second **switch time block (n=2)** here.

After this has been activated, you can configure opening and closing times for both switch time blocks, see page 49.

1. Select and open menu **9.5 [] Weekly programme**.

Setting order

- a) Select the desired switch time programme.

- 1 = Weekly switching times
- 2 = Working day / weekend switching times
- 3 = Individual day switching times

- b) Configure the number of **switching time blocks**.

- n 1 = On, one switching time block is active.
- n 2 = Two switching time blocks are active.

- c) Confirm the setting and continue to set the switching times, see page 49

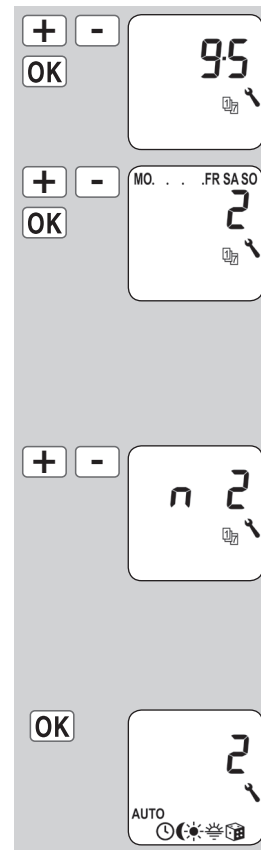



16.7.6 Menu 9.6 - Configure motor speed

The speed of the motor can be configured for recurring automatic functions if necessary (e.g. to reduce noise).

Recurring automatic commands are executed at the configured motor speed.

Manual movement commands and the first automatic run after the system has been operated manually are always executed at maximum motor speed.

1. Select and open menu **9.6 Motor speed**.

- a) Set and confirm the desired speed.

- 1 = low ...
- 2 = medium ...
- 3 = maximum ...
... speed

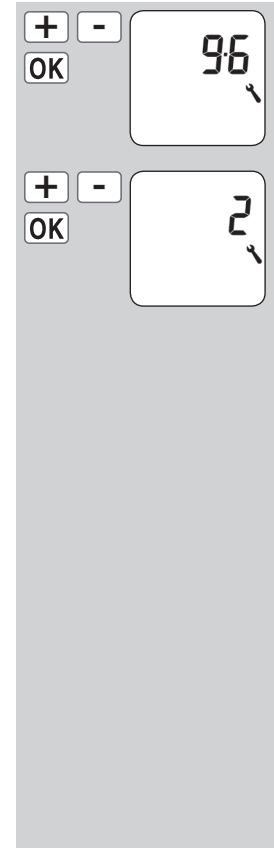



16.7.7 Menu 9.7 - Switch button lock on/off

You can activate the button lock in order to protect the RolloTron Comfort DuoFern against unintentional input.

Automatic activation after approx. two minutes.

If the button lock is activated and no buttons are pressed within a period of two minutes, the button lock is activated automatically.

Direct activation in normal mode

You can also activate and deactivate the button lock directly from the standard display.



The roller shutters can be moved manually, even with the button lock activated.

Activate / deactivate the button lock in the menu.

- Select and open menu **9.7 Button lock**.

- Activate or deactivate the button lock.

On = on
OFF = off

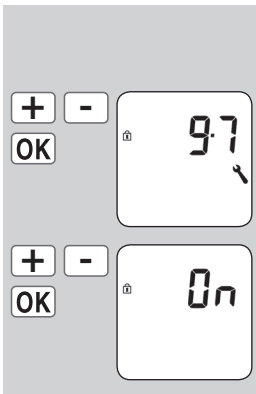

Activate / deactivate the button lock directly from the standard display.

Press and hold the [**SET/Stop**] button for four seconds.



Display for active button lock:

Standard display

When pressing the menu button.

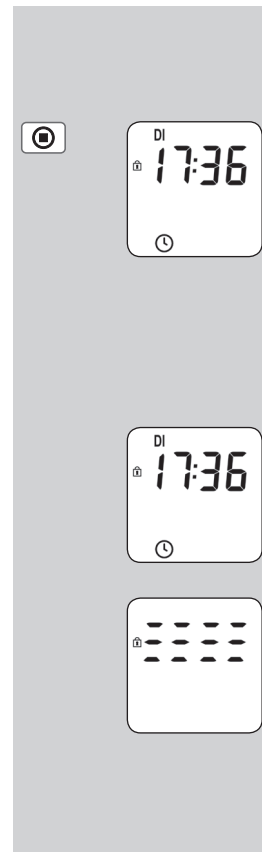



16.7.8 Menu 9.9 - DuoFern settings / overview

We introduce and describe all of the **DuoFern settings** for configuration of the RolloTron Comfort DuoFern starting on page 35.

The DuoFern settings are shown in menu order in **menu 9.9** and the respective sub-menus here.

The **menu overview** for the DuoFern settings together with the corresponding reference pages are listed again here without their full description.



Menu 9 - System settings

Icon	Menu	Page
	<i>9.9</i> DuoFern settings	35
	<i>9.9.1</i> Logging on and off	36
	<i>9.9.2</i> Setting the DuoFern mode	39
	<i>9.9.3</i> Setting the solar mode	41
	<i>9.9.4</i> Switching weather data on/off	43
	<i>9.9.5</i> Display DuoFern address	44

17. Erase all settings, software reset

If necessary, you can erase all of your settings and return the RolloTron Comfort DuoFern system to its original factory settings.

1. Simultaneously press and hold all four buttons for 5 seconds, until all of the icons are shown on the display.

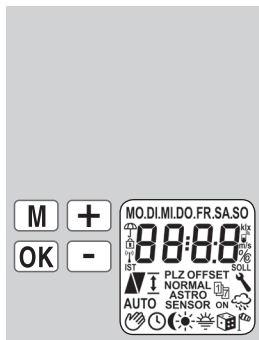

2. Next, the device's software version will be displayed for a few seconds.

All settings will be erased and reset to the default factory settings. Carry out the settings again as specified from page 28 onwards (installation wizard).

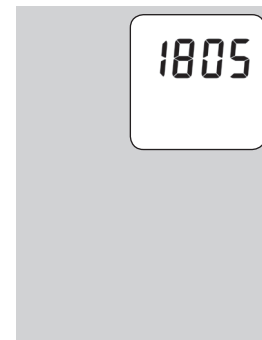

18. Carry out hardware reset

A hardware reset can be carried out in the event that the RolloTron Comfort DuoFern fails to react to commands.

⚠ ATTENTION!

Never press the reset button when the motor is running, as otherwise the end points will be modified.



A hardware reset causes the internal power supply to the RolloTron Comfort DuoFern to be briefly interrupted. All of the previously configured settings will be saved apart from the time and date.

1.  

Press the Reset button using a sharp object (e.g. a paper clip).

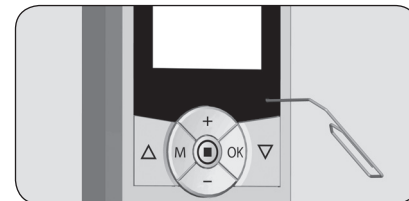



19. Removing the RolloTron Comfort DuoFern (e.g. in the event of a move)

EN

1. **M** + **OK** + **+** + **-** Erase all settings.
Simultaneously press and hold the buttons for 5 seconds.
2. **▽** Fully close the roller shutters.
3. **▽** Keep the button held down.
4. Pull out the belt as far as possible from the top of the RolloTron Comfort DuoFern.
5. Remove the cover plate from the lower mounting holes.
You can remove the front panel by gripping the small notch in the lower side of the device.
6. Remove the mains plug from the socket.
7. Subsequently, release the fastening screws and pull the RolloTron Comfort DuoFern completely out of the belt box.

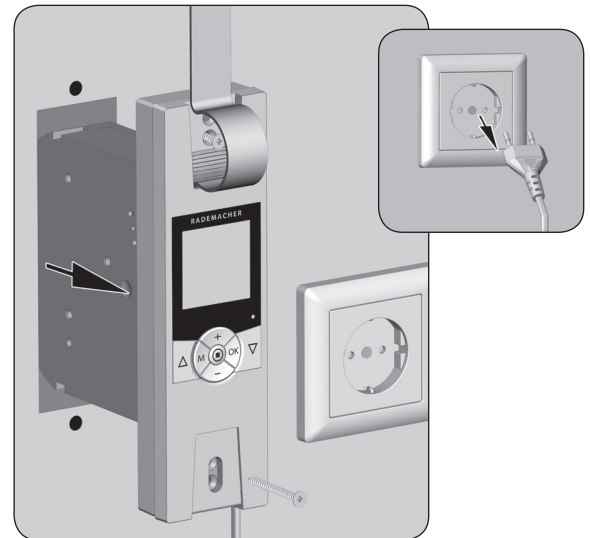



19. Removing the RolloTron Comfort DuoFern (e.g. in the event of a move)

EN

8. Remove the belt compartment cover.
9. Check the position of the fastening hook and move the hook into an easily accessible position if necessary.

CAUTION!

There is a risk of injury from the reel.

- ◆ Never reach into the reel compartment when the motor is running.
- ◆ Always remove the mains plug before touching the reel compartment.

10. Subsequently remove the mains plug permanently from the socket.
11. Release the belt from the fastening hook and pull it out completely from the front of the RolloTron Comfort DuoFern.

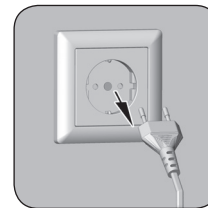
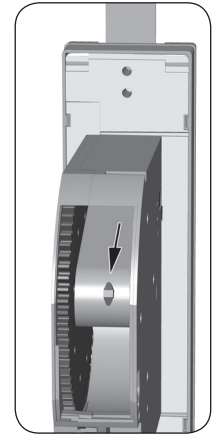
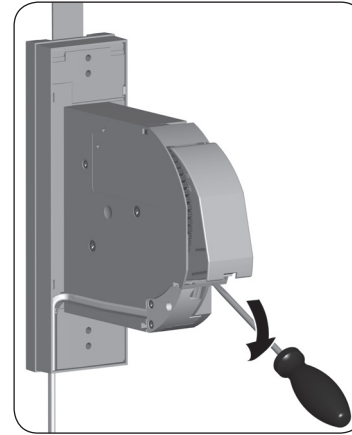



20. Removing the belt in the event of unit failure

In the event that the RolloTron Comfort DuoFern unit fails and the motor no longer runs, you can use the disengaging bracket provided in order to fully remove the belt from the belt winder unit, without the need for cutting it.

1. Remove the mains plug from the socket.
2. Dismantle the RolloTron Comfort DuoFern as previously demonstrated on page 75.

⚠ WARNING!

There is a risk of injury as the roller shutters may slam shut or fall in an uncontrolled manner.

- ◆ Secure the roller shutters from falling.
- ◆ Hold on to the belt tightly to stop the roller shutters from slamming shut or falling in an uncontrolled manner.
- ◆ Get a second person to help you unlatch the unit.

3. Release the drive with the help of the supplied disengaging bracket. A small amount of resistance must be overcome when pressing.
4. Maintain pressure on the disengaging bracket and pull the belt out of the RolloTron as far as possible.

5. Release the belt from the fastening hook and pull it out completely from the RolloTron.
6. Replace the disengaging bracket in its holder.

RolloTron
Comfort
DuoFern

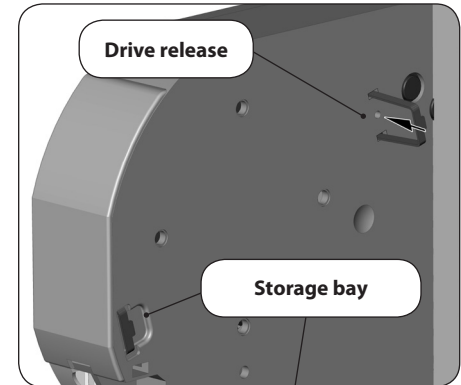

RolloTron
Comfort
DuoFern
Plus

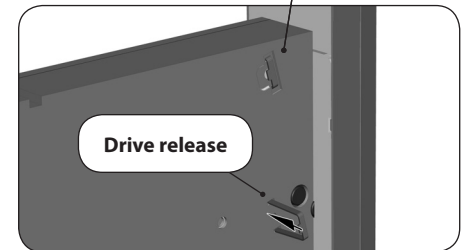



21. What to do if... ?

Fault	Possible cause / solution
... the RolloTron Comfort DuoFern indicates no functions?	Check the power supply incl. connecting cable and plug.
... the RolloTron Comfort DuoFern no longer reacts in the morning at the configured switching time?	<p>The electronic system switched off the drive after closing the roller shutters because the deflection roller stopped turning. This is the case if:</p> <ul style="list-style-type: none"><li data-bbox="805 367 1520 489">a) The [Down] button was pressed for an excessive period of time during the configuration process for the lower end point. The roller shutter slats are closed, but the belt continued to wind and is no longer tight on the deflection roller.<li data-bbox="805 494 1520 659">b) The lower end point is displaced due to elongation of the belt. The belt may never be slack. Reconfigure the lower end point (see page 67) and ensure that the belt remains tight to the deflection roller. In doing so, the deflection roller must turn evenly.
... the roller shutters no longer stop at the configured end points?	The end points may be displaced due to elongation of the belt. Readjust the end points, see page 67.
... the roller shutters stop as soon as the control button is released?	The end points are not configured. Configure the end points, see page 67.
... the RolloTron rotates in the wrong direction?	Possibly the belt is wrapped around the reel incorrectly, see page 22.



21. What to do if... ?

Fault	Possible cause / solution
... the roller shutters stop during downward travel?	a) The roller shutters may have hit an obstacle. Move the roller shutters back up and remove the obstacle.
	b) Slats have shifted out of alignment. If possible, move the roller shutters back up and realign the slats.
	c) The roller shutters scrape against the window frame inside the roller shutter box due to the lack of a pinch roller or insulation material may have come free and is jamming the roller shutters. Open the roller shutter box and rectify the fault. Lubricate any stiff areas with gliding wax if necessary.
	d) The roller shutters are too light. Increase the weight of the roller shutters by, for example, adding a piece of flat steel to the bottom slat.
... the roller shutters stop suddenly during upward travel?	a) The drive may be jammed, for example, due to the roller shutters freezing up or other obstacles.
	b) The roller shutters may not be running sufficiently smoothly. Check the roller shutters and roller shutter guides.
	d) The roller shutters may be too heavy. The maximum tractive force of the belt winder has been exceeded, see page 83.



21. What to do if... ?

EN

Fault	Possible cause / solution
... the RolloTron Comfort DuoFern no longer reacts to manual commands and a temperature icon is shown on the display?	<p>The maximum running time of the drive has been exceeded, see page 9.</p> <p>The motor is too hot. The RolloTron Comfort DuoFern will be operational again in approx. 1 hour.</p>
... the RolloTron Comfort DuoFern no longer reacts to automatic commands and an error message [Er02] is shown on the display?	<p>a) The RolloTron Comfort DuoFern is no longer ready for operation. Carry out a hardware reset in accordance with page 74.</p> <p>b) If the error persists after carrying out a hardware reset, dismantle the RolloTron Comfort DuoFern and have the device repaired by a specialist dealer.</p>

Maintenance

 **CAUTION!**

Inadequate maintenance may lead to personal injury through damage to your RolloTron Comfort DuoFern and to the roller shutter system.

- ◆ Please check the RolloTron Comfort DuoFern and all of your roller shutter components regularly for damage.
 - Regularly check the RolloTron Comfort DuoFern for its correct functionality.
 - The shutters must not be damaged.
 - The belt must not be frayed.
 - The deflection roller on the roller shutter box must move freely.
 - The winding reel in the roller shutter box must be attached and stable. After a longer period of use, this may lose its stability.
 - ◆ Have damages components exchanged by a specialist firm.
-

Care

You can clean the RolloTron Comfort DuoFern using a lightly dampened cloth. Please do not use aggressive or abrasive cleaning agents.

Supply voltage:	230 V / 50 Hz; 230 V / 60 Hz
Nominal power:	70 W
Standby power:	< 0.6 W
Nominal torque:	
- RolloTron Comfort DuoFern	10 Nm
- RolloTron Comfort DuoFern Plus	14 Nm
Maximum speed:	
- RolloTron Comfort DuoFern	30 RPM.
- RolloTron Comfort DuoFern Plus	24 RPM.
Maximum tractive force:	see page 83 (tractive force diagrams)
Transient operation (KB):	4 minutes (maximum running time)
Protection class:	II
Protection type:	IP20 (only for use in dry rooms)
Number of switching times:	max. 28
Configurable range for:	
- automated solar function:	4,000 to 40,000 Lux
- automatic dusk function:	4 to 40 Lux
Permissible ambient temperature:	0 - 40 °C
Noise pressure level (LpA):	≤ 70 dB(A)
Mains connecting cable:	2 x 0.75 mm ² (H03VVH2-F)
Transmission frequency:	434.5 MHz
Transmission power:	max. 10 mW
Range within a building:	10 to 15 m
Max. number of DuoFern transmitters:	20
Dimensions:	see page 18

Power reserve

The RolloTron Comfort DuoFern has a power reserve of approx. 8 hours.

Data retention subsequently to power failure

All of the previously configured settings will be retained subsequent to a power outage, with the exception of the time and date. As soon as the power supply is restored, the opening and closing times will be executed again.

Example:

- ◆ Power failure from 22:30 - 6:30 hours.
- ◆ The opening time has been set to 06:00 a.m.
- ◆ Shortly after power is returned, the switching command will be executed and the roller shutters will open.



24. Tractive force diagrams

EN

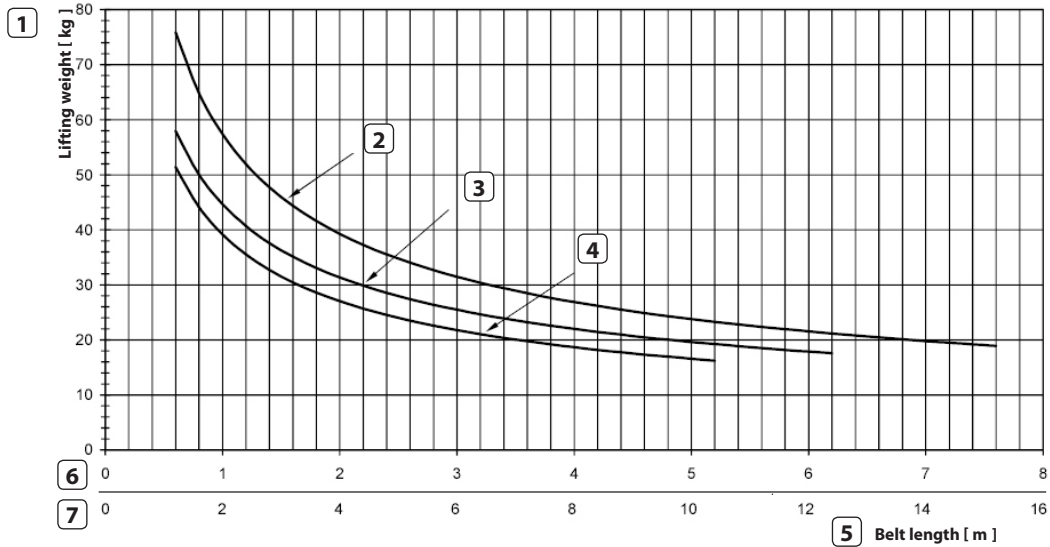

- 1 Lifting weight [Kg]
- 2 Belt thickness 1.0 mm
- 3 Belt thickness 1.3 mm
- 4 Belt thickness 1.5 mm
- 5 Belt length [m]
- 6 Belt lengths for RolloTron Comfort DuoFern
- 7 Belt lengths for RolloTron Comfort DuoFern Plus



25. Factory settings

Automatic:	On
Timer periods:	On
Up time: 07:00	
Down time:	20:00 hours, switch time mode [Normal]
Automatic solar function:	OFF
random function:	OFF
Time / date:	12:00 hours / 01.12.2016
Postcode:	34
Weekly programme:	1 (weekly switching times)
Maximum speed:	3 = Maximum (in automatic mode)
Display backlighting:	0
Automatic summer / winter changeover:	On
Button lock:	OFF
Ventilating position:	OFF
DuoFern mode:	3 (DuoFern receiver)
Solar mode:	1 (local light sensor)
Display weather data:	OFF

Belgium

101 Antwerp
102 Bruges
103 Brussels
104 Liege
105 Mechelen
106 Mons
107 Ostend

Denmark

108 Aalborg
109 Ringsted
110 Esbjerg
111 Horsens
112 Kolding
113 Copenhagen
114 Svendborg
115 Randers

England

116 Aberdeen
117 Birmingham
118 Bristol
119 Glasgow
120 London
121 Manchester
122 Newcastle

Estonia

123 Tallinn

Finland

124 Helsinki
125 Jyväskylä
126 Oulu
127 Tampere
128 Turku
129 Vasa

France

130 Bordeaux
131 Brest
132 Dijon
133 Le Havre
134 Lyon
135 Montpelier
136 Nantes
137 Nice
138 Paris
139 Reims
140 Strasbourg
141 Toulon

Italy

142 Bologna
143 Bolzano
144 Florence
145 Genoa
146 Milan
147 Naples
148 Palermo
149 Rome
150 Turin
151 Venice

Ireland

152 Cork
153 Dublin
154 Belfast

Latvia

155 Riga

Liechtenstein

156 Vaduz

Lithuania

157 Vilnius

Luxembourg

158 Luxembourg

The Netherlands

159 Amsterdam
160 Eindhoven
161 Enschede
162 Groningen
163 Maastricht
164 Rotterdam
165 Utrecht

Norway

166 Oslo
167 Stavanger
168 Bergen
169 Trondheim

Austria

170 Amstetten
171 Baden
172 Braunau
173 Brixen
174 Bruck/Mur
175 Eisenstadt
176 Graz
177 Innsbruck
178 Klagenfurt
179 Landeck
180 Linz
181 Nenzing
182 Salzburg
183 Vienna

Poland

184 Wrocław
185 Bromberg
186 Danzig

187 Kattowitz
188 Krakow
189 Lodz
190 Lublin
191 Posen
192 Stettin
193 Warsaw

Portugal

194 Faro
195 Lisbon
196 Porto

Switzerland

197 Basel
198 Bern
199 Andermatt
200 Chur
201 Lausanne
202 Lucerne
203 Zurich

Sweden

204 Boras
205 Gavle
206 Göteborg
207 Helsingborg
208 Jönköping
209 Östersund
210 Malmö
211 Stockholm
212 Sundsvall
213 Umea

Spain

214 Almería
215 Alicante

216 Barcelona
217 Bilbao
218 Badajoz
219 Burgos
220 Cáceres
221 Castellón
222 Granada
223 Guadalajara

224 La Coruña
225 Lérida
226 León
227 Madrid
228 Murcia
229 Oviedo
230 Palma
231 Pamplona
232 San Sebastián
233 Seville
234 Santander
235 Valencia
236 Valladolid
237 Vitoria
238 Saragossa
239 La Palma
240 Tenerife
241 Grand Canaria
242 Fuerteventura

South-east Europe

243 Athens
244 Belgrade
245 Bratislava
246 Bucharest
247 Budapest

248 Istanbul
249 Maribor
250 Prague
251 Sarajevo
252 Sofia
253 Skopje
254 Thessaloniki
255 Zagreb



27. Simplified EU Declaration of Conformity

EN



RADEMACHER Geräte-Elektronik GmbH hereby declares that the RolloTron Comfort DuoFern complies with the Directives **2006/42/EC (Machinery directive)** and **2014/53/EU (Radio Equipment Directive)**.

The full text of the declaration of conformity is available at the following website:

www.rademacher.de/ce



28. Accessories

A comprehensive range of accessories is available for customising your RolloTron Comfort DuoFern to local conditions.

Further information about our accessories is available at the following website:

www.rademacher.de/zubehoer

Light sensor:

Item no.	Cable length
7000 00 88	0.75 m
7000 00 89	1.5 m
7000 00 90	3 m
7000 00 91	5 m
7000 00 92	10 m

RADEMACHER Geräte-Elektronik GmbH provides a 36-month warranty for new systems that have been installed in compliance with the installation instructions. All construction faults, material defects and manufacturing defects are covered by the warranty.

Your statutory warranty claims shall remain unaffected by this warranty.

The following are not covered by the warranty:

- ◆ Incorrect fitting or installation
- ◆ Non-observance of the installation and operating instructions
- ◆ Improper operation or wear and tear
- ◆ External influences, such as impacts, knocks or weathering
- ◆ Repairs and modifications by third party, unauthorised persons
- ◆ Use of unsuitable accessories
- ◆ Damage caused by unacceptable excess voltages (e.g. lightning)
- ◆ Operational malfunctions caused by radio frequency overlapping and other such radio interference

For the warranty to be applicable, the new device must have been purchased through one of our approved specialist retailers. Proof of this can be provided by presenting a copy of the bill.

RADEMACHER shall remedy any defects, which occur within the warranty period free of charge either by repair or by replacement of the affected parts or by supply of a new replacement unit or one to the same value. There is no general extension of the original warranty period by delivery of a replacement or by repair as per the terms of the warranty.

RADEMACHER

Geräte-Elektronik GmbH
Buschkamp 7
46414 Rhede (Germany)
info@rademacher.de
www.rademacher.de

Service:
Hotline 01807 933-171*
Fax +49 2872 933-253
service@rademacher.de

* 30 seconds free of charge, subsequently 14 cents / minute from German fixed line networks and max. 42 cents / minute from German cellular networks.