

H123D X4 JET

《H123D User Manual》

Version 1.0

2 DIFFERENT WAYS TO FLY, 2 CONFIGURATIONS

The First Flight Configuration: Aircraft + HT012D Transmitter

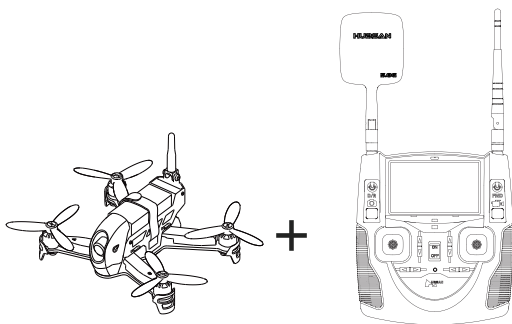

The Second Flight Configuration: Aircraft + HT011 Transmitter

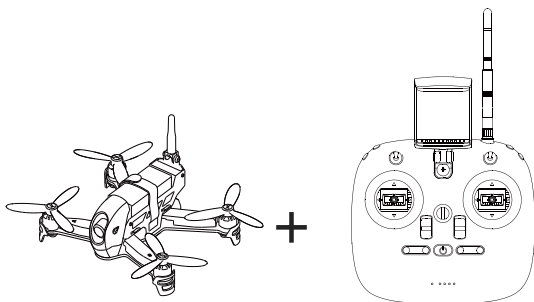

IMPORTANT SAFETY INFORMATION

OPERATION

Be extremely careful and responsible when using the quad. Small electronic components can be damaged due to crashes or exposure to moisture/liquid. To avoid any injuries, do not use the quad with broken or damaged components.

MAINTENANCE

Do not try to open or repair the units by yourself. Please contact Hubsan or Hubsan authorized dealers for service. For more information, please visit the official website at www.hubsan.com.

BATTERY

Do not disassemble, squeeze, impact, burn, drop or trample the battery. Do not short-circuit or put the battery terminal in contact with metal. Do not expose the battery to temperatures above 60 ° C. Charge the aircraft battery prior to flight. Use a Hubsan dedicated charger for charging. Keep the battery out of the reach of children and away from any kind of moisture.

FLIGHT

Please be mindful of personal safety and the safety of others while flying.

- Do not fly in bad weather conditions.
- Do not attempt to catch the aircraft while it is in flight.
- This product is intended for experienced pilots over the age of 14.
- After every flight, completely disarm the aircraft motors and disconnect the aircraft from power. Then, you may power off the remote control.

READ THE DISCLAIMER AND SAFETY GUIDELINES FIRST BEFORE USE.

Symbol Explanation:

 Prohibited Operation

 Instruction

 Important Notice

 Explanation/Reference

USAGE ADVICE

(Hubsan has created the following operational and safety materials):

 Quick Start Guide

Hubsan Safety Advisory Notice for Lithium-Polymer (LiPo) Batteries

LiPo batteries are different from conventional batteries in that their chemical contents are encased in a relatively lightweight foil packaging. This has the advantage of significantly reducing their weight but it does make them more susceptible to damage if roughly or inappropriately handled. As with all batteries, there is a risk of fire or explosion if safety practices are ignored:

- If you do not plan to fly the quad for a long time, store the battery ~50% charged to maintain battery performance and life.
 - Please use Hubsan chargers for battery charging.
 - Discharge the battery at 5C current or below. To avoid discharge related battery damage, do not prolong the discharge time.
 - Do not charge on carpet to avoid fire.
 - Batteries need to be recharged if unused for over 3 months.
- ⊗ 1. Do not disassemble or reassemble the battery.
2. Do not short-circuit the battery.
 3. Do not use or charge near sources of heat.
 4. Do not put the battery in contact with water or any kind of liquid.
 5. Do not charge batteries under sunlight or near fire.
 6. Do not puncture or subject the battery to force of any kind.
 7. Do not throw or manhandle the battery.
 8. Never charge a battery that has been damaged, become deformed or swelled.
 9. Do not solder on or near the battery.
 10. Do not overcharge or over discharge the battery.
 11. Do not reverse charge or reverse the battery polarities.

- ⊘ 12. Do not connect the battery to a car charger/cigarette lighter or any kind of unconventional power source.
- 13. This battery is prohibited for non-designated devices.
- 14. Do not touch any kind of liquid waste or byproduct from batteries. If skin or clothes come in contact with these substances, please flush with water!
- 15. Do not mix other types of batteries with lithium batteries.
- 16. Do not exceed the specified charging time.
- 17. Do not place the battery in a microwave or in areas of high pressure.
- 18. Do not expose the battery to the sun.
- 19. Do not use in environments with high static electricity (64V and above).
- 20. Do not use or charge in temperatures below 0 °C and above 45 °C.
- 21. If a newly purchased battery is used, leaking, possesses a bad smell or other abnormalities, return immediately to the vendor.
- 22. Keep away from the reach of children.
- 23. Use a dedicated battery charger and follow all charging requirements.
- 24. Minors who use the battery and its dedicated unit must be supervised by an adult at all times.

Table Of Contents

Important Safety Information	02	3.4 Horizontal Calibration	16
1. The H123D Aircraft	06	3.5 Takeoff/Landing	16
1.1 Aircraft Component Breakdown	06	3.6 Basic Flight Operation	17
1.2 Charging And Installing The Aircraft Battery	06	3.7 Acrobatics	19
1.3 Installing And Removing The Propellers	07	3.8 Motor Stall Protection	21
1.4 Aircraft LED Indications	08	3.9 Low Power Protection	21
1.5 Adjusting The Aircraft Camera Angle	08	3.10 Loss Of Flight Control Protection	21
1.6 Installing The TF (Micro-SD) Card	08	H123D Frequently Asked Questions	21
2 Transmitters	09	H123D Accessories	22
2.1 The HT012D Transmitter	09		
2.1.1 HT012D Key Functions	09		
2.1.2 Installing The Transmitter Batteries	10		
2.1.3 Transmitter Battery Installation	11		
2.2 The HT011 Transmitter	11		
2.2.1 Getting To Know The HT011	11		
2.2.2 HT011 Function Breakdown	13		
2.2.3 Battery Installation	14		
3 Getting Ready To Fly	14		
3.1 Flight Environment Requirements	14		
3.2 Pre-Flight Checklist	15		
3.3 Binding	15		
3.3.1 Binding The HT012D And Aircraft	15		
3.3.2 Binding The HT011 And Aircraft	15		

1 The H123D Aircraft

1.1 Getting To Know Your H123D

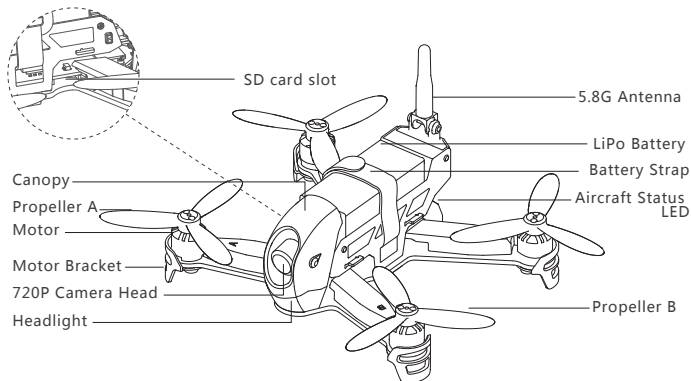

1.2 Charging And Installing The Aircraft Battery

The H123D aircraft is paired with a rechargeable 7.6v, 980mAh Li-Po. Be sure to use the provided Hubsan dedicated charger for charging. Fully charge the battery before flight. Connect the charger's USB adapter to a PC terminal and then the battery to the charger. Charging time is approximately 130min; recommended flight time is 10 minutes. Be sure to charge the battery before each flight.

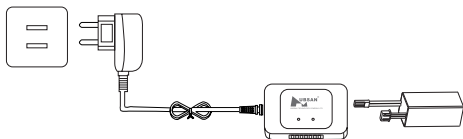

Installation: Push the battery into its compartment with its lines facing away from the unit. Connect it to the drone's power line and coil the power line into the compartment (be careful to avoid entangling the power line with the propellers). Fasten the battery in place with its velcro battery strap.

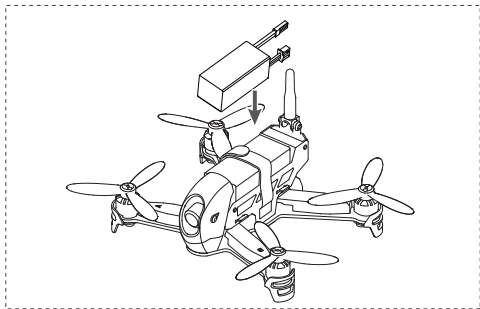

- Make sure the battery is fully charged before each flight.
- Please do not leave unattended while charging.
- When charging is complete, disconnect the charger and battery from power immediately.

1.3 Installing And Removing Propellers

The aircraft propellers are triple bladed; each is marked with either an A or a B. Please replace damaged propellers with genuine Hubsan stock.

Before installing the propellers for the first time, please check whether the propeller and motor arm read "A" or "B". The two letters should match. Only then use two screws per propeller to tighten and secure each to its respective motor shaft.

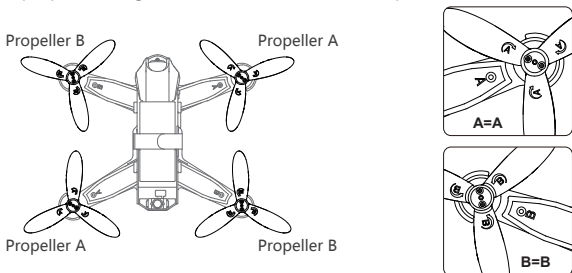

If propellers need to be changed out, please remove the propeller screws first before taking the existing propeller off.

1.4 Aircraft LED Indicators

LED Status	Function And/Or Aircraft Status	
Headlight (White)	During normal flight, the headlight is a solid white. Users may also opt to turn the headlight off.	
Rear LEDs (Both Red)	Power On	All 4 LEDs flash simultaneously
	Flight Control Connection	When the aircraft is not connected to a transmitter or has been disconnected from a transmitter, the right rear LED will flash slowly. Upon connection with a transmitter, the right rear LED will become solidly lit.
	Horizontal Calibration	Left and right rear LEDs flash alternately. All LEDs turn solid when calibration is complete.
	Photo	When the user takes a photo, both rear LEDs will flash together once.
	Video	When the user records a video, both rear LEDs will flash together slowly.
	Low Power	Both rear LEDs will flash together rapidly (this indication takes priority over all others when power is low).

1.5 Adjusting The Aircraft Camera Angle

To change the aircraft's camera angle, use a screwdriver to loosen the screws holding the camera head in place. Manually adjust the camera head accordingly as desired (downwards 8 degrees max, upwards 45 degrees max) and firmly tighten the screws afterwards.

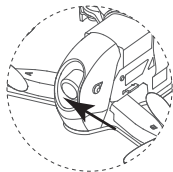

1.6 Installing The TF (Micro-SD) Card

Locate the TF (Micro-SD) slot at the bottom of the aircraft. Insert the Micro-SD into the aircraft to take photos and make video recordings.

Installation:

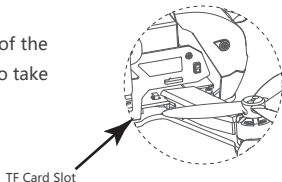

2 Transmitters

2.1 The HT012D Transmitter

2.1.1 HT012D Key Functions

Mode 1 (Japanese Hand)

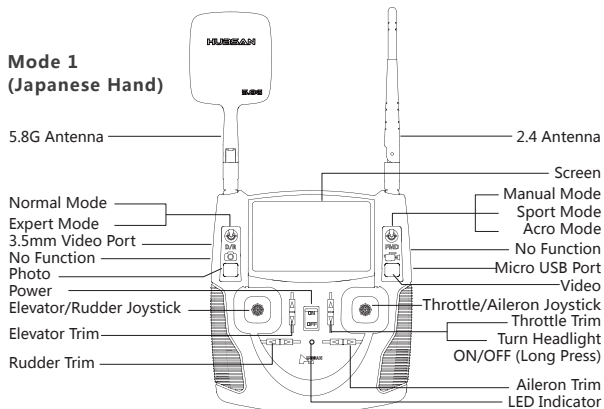

Mode 2 (American Hand)

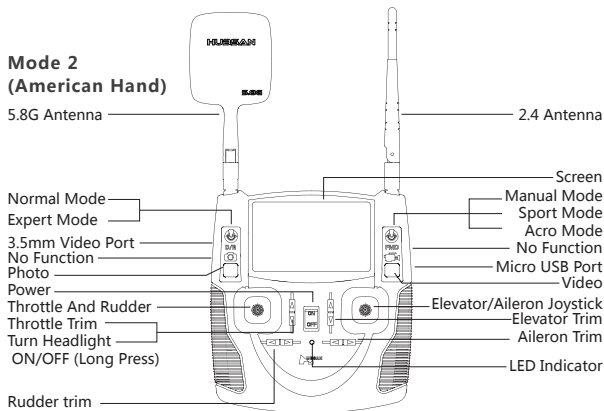

2.1.2 HT012D Key Functions

No.	Key/Button/Switch	Function
(1)	Throttle /Aileron Joystick	Push the stick forward or backward and the quadcopter will ascend or descend (respectively). Push the stick left or right and the quadcopter will fly left or right (respectively).
(2)	Elevator /Rudder Joystick	Push the stick forward or backward and the quadcopter will fly forwards or backwards (respectively). Push the stick left or right and the quadcopter will rotate counterclockwise or clockwise (respectively).
1	Throttle /Rudder Joystick	Push the stick forward or backward and the quadcopter will ascend or descend (respectively). Push the stick left or right and the quadcopter will rotate counterclockwise or clockwise (respectively).
2	Elevator /Aileron Joystick	Push the stick forward or backward and the quadcopter will fly forwards or backwards (respectively). Push the stick left or right and the quadcopter will fly left or right (respectively).
3	Aileron Trim	Use the Aileron trim to adjust for left and right horizontal drift.
4	Elevator Trim	Use the Elevator trim to adjust for forward and backward drift.
5	Rudder/Yaw Trim	Use the Rudder trim to adjust for counterclockwise and clockwise rotation/yaw drift.
6	Throttle Trim	Throttle trim is normally centered. If the throttle channel is not centered, use the Throttle trim to adjust.
7	Power	Push up/ON to turn on the transmitter. Push down/OFF to turn off.
8	Photo	Press once to take a photo.
(8)	Video	Press to start and end video recordings. Note: Photos cannot be taken while a video is recording. Attempts to do so will stop in-progress recordings.
9	USB Port	Not supported for charging or upgrading.
10	Normal /Expert Mode	Normal Mode: Throttle 100%, Elevator 60%, Aileron 60%, Expert Mode: Throttle 100%, Elevator 100%, Aileron 100%, Rudder/Yaw
11	Flight Mode	Manual Mode: Operating under full stabilization- no acro is possible. Sport Mode: Operating under partial stabilization- no acro is possible, but flight is relatively flexible. Acro Mode: Operating with no stabilization- acro is possible and flight will be very flexible. (Novice pilots are recommended to use Manual Mode).

2.1.3 Transmitter Battery Installation

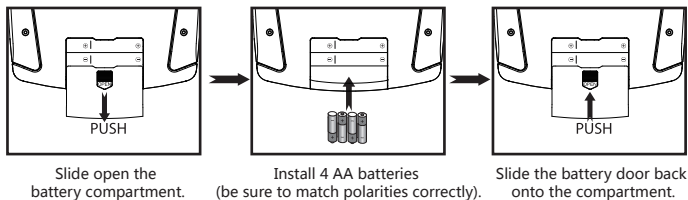

- Do not mix new and old batteries.
- Do not cross-use different types of batteries at the same time.
- Do not charge non-rechargeable batteries.



2.2 The HT011 Transmitter

2.2.1 Getting To Know The HT011

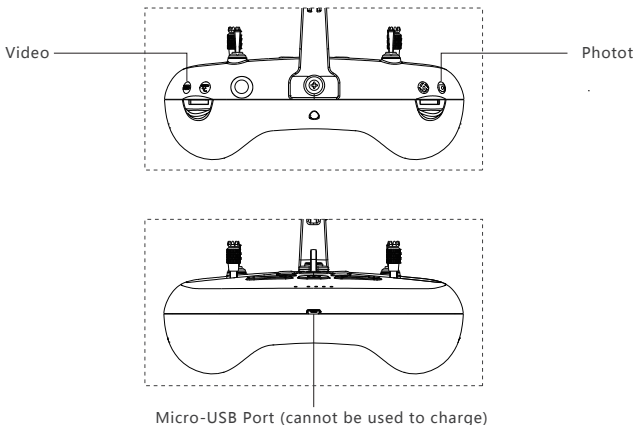

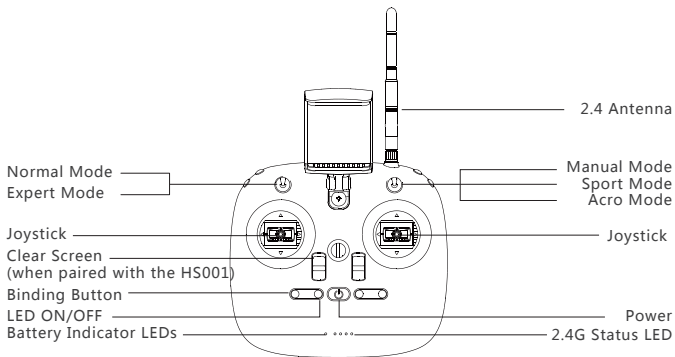

When this transmitter is paired with the H123D, some of the keys and buttons will have no functions.

2.2.2 HT011 Function Breakdown

No.	Key/Button/Switch	Function
(1)	Throttle /Rudder Stick	Push the stick forward or backward and the quadcopter will ascend or descend (respectively). Push the stick left or right and the quadcopter will rotate counterclockwise or clockwise (respectively).
(2)	Elevator /Aileron Stick	Push the stick forward or backward and the quadcopter will fly forwards or backwards (respectively). Push the stick left or right and the quadcopter will fly left or right (respectively).
1	Throttle/Aileron Stick	Push the stick forward or backward and the quadcopter will ascend or descend (respectively). Push the stick left or right and the quadcopter will fly left or right (respectively).
2	Elevator /Rudder Stick	Push the stick forward or backward and the quadcopter will fly forwards or backwards (respectively). Push the stick left or right and the quadcopter will rotate counterclockwise or clockwise (respectively).
3	Binding	Power on the transmitter while holding down the binding button.
4	Power Switch	Long press to power on/power off the transmitter.
5	Photo	Short press to take photos.
6	Video	Short press to start and end video recordings.
7	Normal /Expert Mode	Normal Mode: Throttle 100%, Elevator 60%, Aileron 60%, Rudder/Yaw 60%;Expert Mode: Throttle 100%, Elevator 100%, Aileron 100%, Rudder/Yaw 100%
8	Flight Mode	Manual Mode: Operating under full stabilization- no acro is possible. Sport Mode: Operating under partial stabilization- no acro is possible, but flight is relatively flexible. Acro Mode: Operating with no stabilization- acro is possible and flight will be very flexible. (Novice pilots are recommended to use Manual Mode).
9	LED ON/OFF	Short press to turn on aircraft LEDs and short press again to shut off LEDs.
10	Status LEDs	Battery Voltage LED (low power): If the aircraft voltage is at or below 6.8V, the LED will slowly flash. If the voltage is above 6.8V, the LED will be solid. 2.4G Status LED: If the transmitter is not paired/connected to a device via the 2.4G frequency, the LED will be completely off. If the transmitter is paired/connected to a device via the 2.4G signal, the LED will be solidly lit.
11	Micro-USB Port	Not supported for charging or upgrading.
12	Clear Screen	When paired with the HS001 display, push upwards to clear the screen; push downwards to show content.

2.2.3 Battery Installation

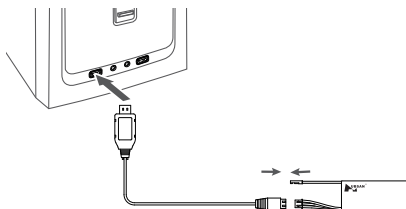

It is recommended that users implement some kind of flight training (i.e using a simulator for flight practice, seeking professional guidance, etc.) before flying. Please select an appropriate environment for flight.

3 Getting Ready To Fly

3.1 Flight Environment Requirements

- (1) Select an open environment devoid of high rise buildings and tall obstructions (such as trees and poles).
- (2) Do not fly in bad weather conditions (such as in wind, rain or fog).
- (3) Fly the drone in ambient temperatures of 0-40 °C.
- (4) When flying, please stay away from obstructions, crowds, high voltage lines, trees, water, etc.
- (5) To avoid remote control signals interference, do not fly in complex electromagnetic environments (such as venues with radio stations, power plants and towers).
- (6) The H123D cannot be used in or near the Arctic circle or Antarctica.
- (7) Do not fly in no fly zones.
- (8) Do not operate the aircraft near high pressure lines.



High Pressure Lines



Airports



Magnetic Interference



Rain

3.2 Pre-Flight Checklist

- (1) Make sure the aircraft battery and mobile device are charged and have adequate power.
- (2) Confirm that propellers and screws are properly installed.
- (3) If you are taking pictures, insert the Micro-SD card required for taking pictures and videos.
- (4) Verify that the motors arm and spin smoothly.
- (5) Ensure the camera lens is clean.

3.3 Binding

3.3.1 Binding The HT012D And Aircraft

- (1) Pull and hold the throttle to its lowest position.
- (2) Hold down the Photo key and power the transmitter on. The transmitter's status LED will flash red; please do not press or touch any other keys, buttons or sticks while this process is ongoing. Users may let go of the Photo key and throttle. Connect the aircraft to its battery and allow it to bind to the transmitter. The two must be very close to each other; when the bind is successful, the binding status LED will turn green.

Mode 2 depicted

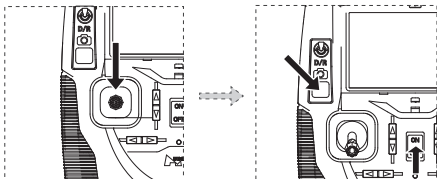

3.3.2 Binding The HT011 And Aircraft

- (1) Pull and hold the throttle to its lowest position.
- (2) Hold down the binding key and power the transmitter on. Users may let go of the binding key and throttle. Please do not press or touch any other keys, buttons or sticks while this process is ongoing, or the aircraft may exhibit instability while flying.

Mode 2 depicted

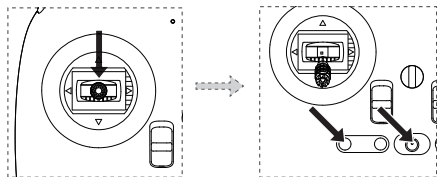

For both configurations, flight operation is mostly the same. This manual will describe operation on the HT012D remote as an example.

3.4 Horizontal Calibration

Horizontal calibration is required when the aircraft drifts on the horizontal plane during flight. When this happens, land the aircraft and disarm its motors. Follow the below steps to do a horizontal/gyro calibration.

1. Place the aircraft on a completely flat surface and then follow the below calibration procedure. Hold the left stick to the right side of its socket. Rapidly and continuously wiggle the right stick left and right until the rear LEDs flash alternately.
2. Calibration is complete when the LED indicators stop flashing. It is recommended that users wait for 15-20 seconds after the calibration is completed before flying again.

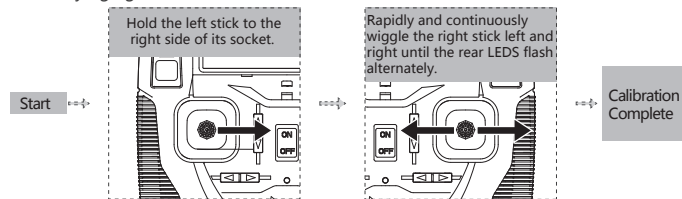

3.5 Taking Off And Landing

(Note: Novice pilots are recommended to use Sport Mode 0).

Takeoff

Simultaneously pull the transmitter joysticks diagonally down-out to arm the motors (as shown in the below figure). Pull the left joystick (throttle) upwards to takeoff.

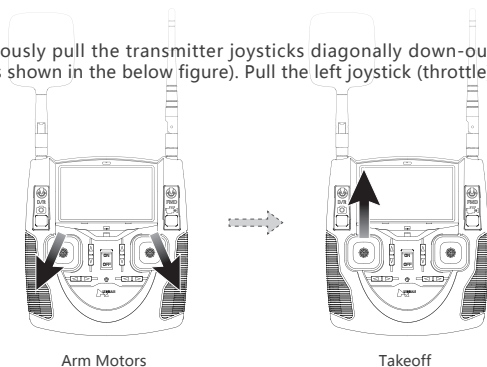

Landing

Slowly and gently pull the throttle joystick down until the copter has completed its descent on the ground. Simultaneously pull the transmitter joysticks diagonally down-out to disarm the motors (as shown in the right figure). After all motors have come to a complete stop, release the joysticks.

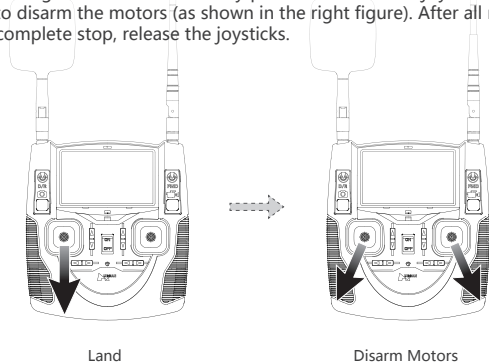

3.6 Basic Flight Operation

Note: When flying the aircraft, be sure to slowly and firmly manage the controls. With every joystick maneuver the aircraft will lose a little power, so be sure to use a little extra throttle to keep the aircraft airborne.

(1) The throttle controls the aircraft's ascent and descent.

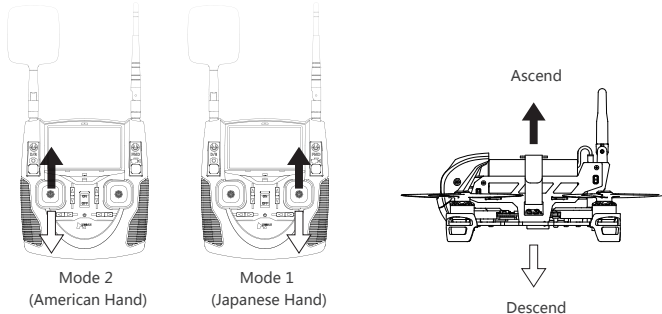

(2) The rudder is used to control the aircraft's rotations.

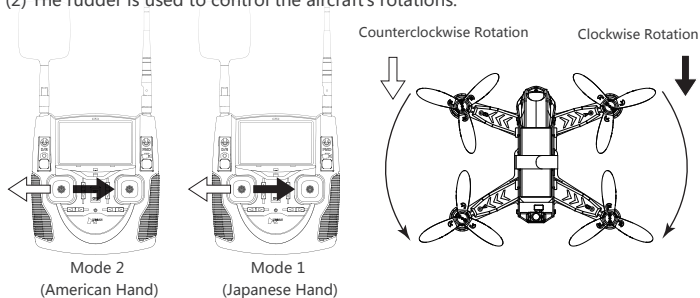

(3) The elevator controls the aircraft's forward and backward movement.

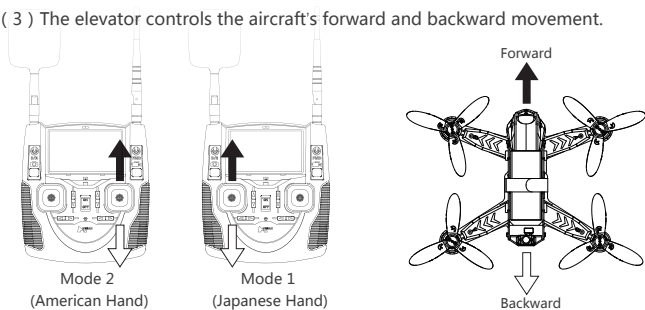

(4) The aileron controls the aircraft's left and right movement.

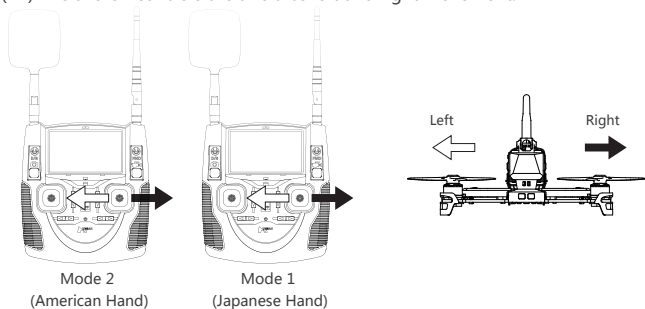

3.7 Acrobatics



The H123D is capable of 360° rollovers and flips; you may use this capability by following the below steps. To better perform flips and rolls, please ensure that the aircraft is at a safe height from the ground. It is best to roll and flip the aircraft while it is ascending, so that it more easily maintains its height after flipping or rolling.

Make sure that the transmitter is set to Acro Mode before attempting acrobatics.

(1) Left Roll

Steady the throttle and push the aileron stick right. The aircraft will perform a left roll. When the roll is complete, please center the aileron joystick and adjust the aircraft's position accordingly.

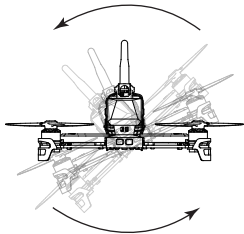
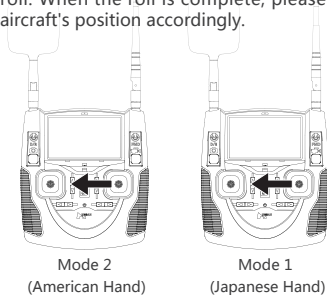

(2) Right Roll

Steady the throttle and push the aileron stick right. The aircraft will perform a right roll. When the roll is complete, please center the aileron joystick and adjust the aircraft's position accordingly.

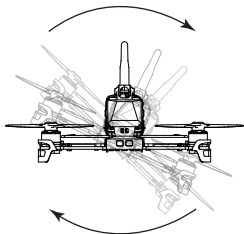
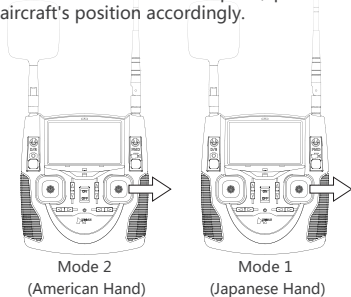

(3) Front Flip

Steady the throttle and push the elevator stick forward. The aircraft will perform a forward flip. When the flip is complete, please center the elevator joystick and adjust the aircraft's position accordingly.

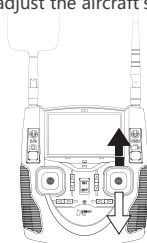

Mode 2
(American Hand)

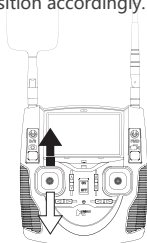

Mode 1
(Japanese Hand)

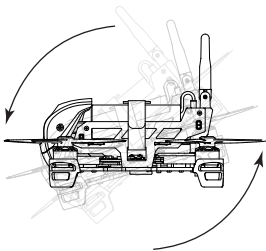

(4) Back Flip

Steady the throttle and pull the elevator stick backward. The aircraft will perform a back flip. When the flip is complete, please center the elevator joystick and adjust the aircraft's position accordingly.

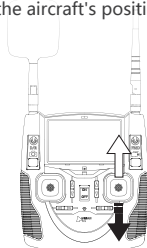

Mode 2
(American Hand)

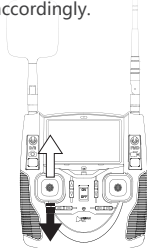

Mode 1
(Japanese Hand)

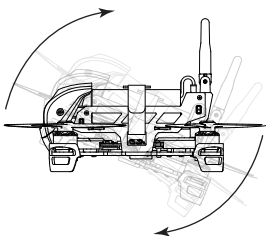

Note: After flying, please power the aircraft off first, followed by the transmitter.

3.8 Motor Stall Protection

When aircraft crashes or its propellers encounter blockage/obstruction, the motors will automatically disarm to prevent further damage.

3.9 Low Power Protection

When the aircraft battery is low, the aircraft will beep and its rear LEDs will flash. When the aircraft battery has reached its maximum flight limit, the aircraft will slowly descend.

3.10 Loss Of Flight Control Protection

When the aircraft and transmitter lose connection after 3 or more seconds, the aircraft will automatically descend.

H123D Frequently Asked Questions

1. Aircraft and remote control are not pairing

- (1) Check that the aircraft and remote control are both powered on.
- (2) Turn off both the aircraft and remote control. Rebind the aircraft to the remotecontrol.

2. No video on the screen or user is experiencing strong video feed interference

- (1) Check whether there are strong sources of wireless interference (i.e. WIFI, electricity, radio tower frequencies, etc). If there are any, please change your flight location.
- (2) Rebind the copter to the transmitter, as the 5.8 and 2.4 frequencies might be interfering with each other.
- (3) Browse through the selection of available 5.8GHz frequencies to find a clean channel.

3. Aircraft/video feed is shaking/shaky

- (1) Check if the aircraft propellers are deformed or broken. Please replace them.
- (2) Check that all aircraft body screws are firmly in place.
- (3) Check whether any motor shafts are broken. Motors must be replaced if the shafts are broken.

4. Cannot take videos or pictures

- (1) Check to see that the SD card is installed in the aircraft prior to power on.
- (2) Make sure the SD card is formatted correctly.

H123D Accessories



H123D-01
Canopy



H123D-02
Headlight Cover+Rear
Lamp Lens



H123D-03
Antenna Base+Antenna
Tube Sheath+ Rear
Canopy+ Battery Port
Cover



H123D-04
Motor Mount



H123D-05
Support Frame
Camera Head Mount
Camera Back Cover



H123D-06
ESC Guard A/B



H123D-07
ESC

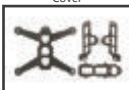

H123D-08
Carbon Fiber Racing
Frame



H123D-09
Camera Head



H123D-10
PCB Motherboard



H123D-11
Screw Set (Complete)



H123D-12
Propellers A/B (Screws
Included)



H502-19
Screwdriver



H123D-13
2.4G/5.8G Antenna



H123D-14
HT011-B Transmitter



H502-18
Transmitter Battery USB
Charger (7.4V)



H123D-15
HT012D Transmitter
(Sunshade Included)



H123D-16
HS001 LCD Display
(Sunshade Included)



H123D-17
Aircraft Battery



H123D-18
Brushless Motors



H123D-19
Wall Adapter



H123D-20
Balance Charger

Notice: Please read the operating instructions carefully before use!



- Never leave units unattended when charging
- Unplug the charging cable immediately after charging
- Propellers may cause injury
- This product is not a toy
- Not suitable for children under 14 years of age

WWW.HUBSAN.COM

Product name: X4 Jet

Vendor: Shenzhen Hubsan Technology Co., Ltd

Address: 13th Floor, Block C, Shenzhen Software Industrial Base, Xuefu Road, Nanshan District, Shenzhen, Guangdong Province, China

Manufacturer: Dongguan Teng Sheng Industrial Co., Ltd.

Address: Dongguan City, Guangdong Province, Tangxia Tianke Branch City Road, A22

Telephone: 0769-82776166 (China)