



ITP14

Universal process indicator

User guide

Contents

1	Overview	2
2	Specifications.....	2
2.1	Galvanic isolation	2
2.2	Environmental conditions	2
3	Intended use	3
4	Functions	3
5	Installation	3
5.1	Wiring.....	4
5.1.1	Input	5
5.1.2	Output	5
6	Operation	5
6.1	Control	5
6.2	Alarm.....	6
6.3	Filter	6
6.4	Square root function	7
6.5	Error	7
7	Programming.....	7
8	Maintenance	10
9	Transportation and storage	10
10	Scope of delivery	10
Appendix A.	Dimensions	10

1 Overview

ITP14 is a universally applicable process indicator and can be used with various current or voltage standard signals. The device requires 24V DC auxiliary voltage. It is designed for control and monitoring of industrial processes.

2 Specifications

ITP14 can be ordered in two versions. They differ in the display color. Ordering key:

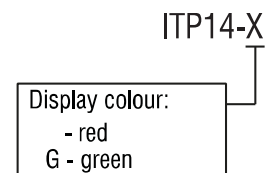

Table 2.1 Technical data

Power supply	24 (10...30) V DC
Power consumption, max.	1 W
Input	1
Input signal	0-5 mA, 0(4)-20 mA, 0(2)-10 V
Sampling time	0.3 s
Accuracy	± (0.2% FS + 1 digit)
Temperature influence	≤ 0.2% / 10 °C
Input resistance	
0-5 mA, 0(4)-20 mA	≤ 120 ohm
0(2)-10 V	≥ 250 kohm
Output	1
Type	NPN transistor
Loading capacity	200 mA, 42 V DC
Enclosure	for panel mounting
Character height	14 mm
Dimensions	48 x 26 x 65 mm
Weight	approx. 30 g

Table 2.2 Linear signals

Display	Input signal	Measurement range, %
0-5	0-5 mA	0...100
0-20	0-20 mA	
4-20	4-20 mA	
0-10	0-10 V	
2-10	2-10 V	

2.1 Galvanic isolation

The ITP14 has three potential groups:

- Power supply 24 V DC
- Analog input
- Digital output

Galvanic isolation from each group to enclosure 500 V

Galvanic isolation between groups 500 V

2.2 Environmental conditions

The device is designed for natural convection cooling. It should be taken into account when choosing the installation site.

The following environment conditions must be observed:

- clean, dry and controlled environment, low dust level

- closed non-hazardous areas, free of corrosive or flammable gases

Table 2.3

Conditions	Permissible range
Ambient temperature	-40...+60 °C
Storage temperature	-25...+55 °C
IP Code	front IP65, rear IP20
Protection class	III
Relative humidity	up to 80% (at +35°C, non-condensing)

3 Intended use

The device may only be used in the manner described in this user guide, properly installed and in accordance with the specification. Damages caused by disregarding the instructions of this manual are without liability. Non-observance of the safety guidelines may result in damage to the device and injury to personal.

Improper use

Any other use is considered improper. Especially to note:

- The ITP14 may not be used for medical devices that sustain, monitor or otherwise affect human life or health.
- The device may not be used if the environmental conditions (temperature, humidity etc.) are not within the limits indicated in the specification.
- The device may not be used in potentially explosive environment or in an atmosphere with chemically active substances.

4 Functions

A 4-digit LED display with 14 mm character height is located on the front of the device to display the process value or error messages in operation (see 6) and programming parameters in programming mode (see 7). The function buttons are positioned on the rear part of the device.

Main functions:

- Analog input 0-5 mA, 0(4)-20 mA, 0(2)-10 V
- Measuring and displaying of a process value
- Signal scaling
- Adjustable decimal point position
- Display range -999...9999
- ON/OFF control with NPN output
- Square root function (for special transmitters)
- Digital filter
- Alarm function
- Error indication when the input signal is out of range
- Error indication when wire break or short circuit

5 Installation



Improper installation can cause serious or minor injuries and damage the device. Installation must be performed only by fully qualified personnel.

The device is designed for panel mounting in a borehole of Ø22.5 mm (see Appendix A for dimensional drawings).

Carefully position the supplied gasket on the display rear surface. Insert the cylindrical body of the device into the borehole and tighten the nut from the rear side of the panel.

5.1 Wiring



CAUTION

Switch on the power supply only after the wiring of the device has been completely performed



NOTICE

Switch off the device before checking the sensor and connection lines. For circuit integrity check use only the measuring device with the output voltage max. 4.5 V to prevent the device damage. Disconnect the sensor in case of higher voltage.



NOTICE

Signal cables should be routed separately or screened from the supply cables. Only a shielded cable may be used for signal lines.

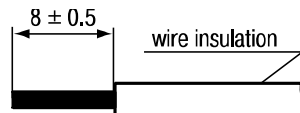

Fig. 5.1 Wire preparation

Do not use wire end ferrules to connect stranded wires.

To connect fine-stranded wire, tin the wire end.

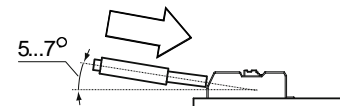

Fig. 5.2 Connecting the wire to the terminal

To connect solid wire, push the wire into the terminal.

To connect stranded wire, press the release lever and push the wire into the terminal.

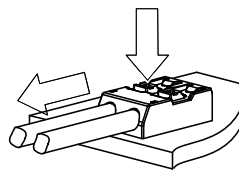

Fig. 5.3 Disconnecting the wire

Press the release lever to free the wire.

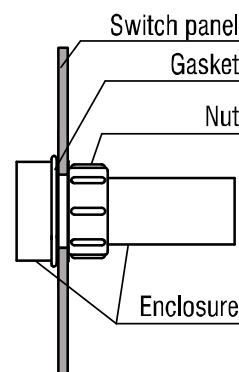

Fig. 5.4 Mounting

- The electrical connections are shown in Fig. 5.5-5.7, the terminal assignments in Table 5.1.
- Ensure that the device is provided with its own power supply line and electric fuse $I = 0.5$ A.
- Solid conductor cross-section: $0.2...0.8$ mm². Stranded conductor cross-section: $0.45...0.7$ mm². Wires should be stripped for approx. 8 mm.

5.1.1 Input

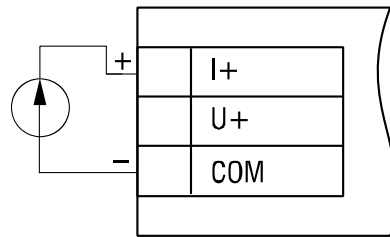

Fig. 5.5 Current sensor wiring

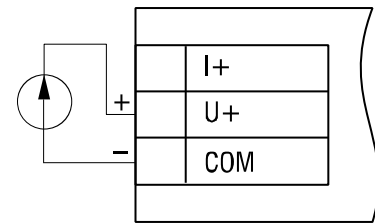

Fig. 5.6 Voltage sensor wiring

Table 5.1 Terminal assignment

Designation	Description
24VDC -	Power supply
24VDC +	
DO-	Output -
DO+	Output +
COM	Common -
U+	Voltage input +
I+	Current input +

5.1.2 Output

The NPN transistor output is designed to control the low voltage relay up to 42 V DC / 200 mA

► NOTICE

As a precaution against inadvertent current reversal on output, a parallel diode ($U_{VD} \geq 1.3U$, $I_{VD} \geq 1.3I$) is usually included in the output circuit.

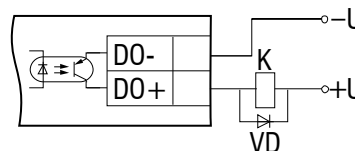

Fig. 5.7 NPN transistor output

6 Operation

After the device is powered on the operating mode is activated. The type of the signal can be selected in the parameter **in.t** "Input signal". The complete list of the programming parameters is shown in Table 7.2.

The input signal is digitalised, the square root calculated (if the function is enabled), the signal scaled and displayed. The scale factor is calculated based on the parameter **di.Lo** "Lower measuring limit" and **di.Hi** "Upper measuring limit". The display decimal point can be specified in the parameters **di.P**.

For other signal processing functions see sections 6.1...6.3. For displayed errors see Table 6.1.

6.1 Control

ON/OFF control is implemented with the NPN transistor output (see 5.1.2). The parameters **SP.Lo** "Lower setpoint limit" and **SP.Hi** "Upper setpoint limit" specify the control limits. The control function can be selected in the parameter **Cnt**:

- Heating
- Cooling
- Alarm within limits
- Alarm outside limits

The safe output state can be selected in the parameter **out.E**.

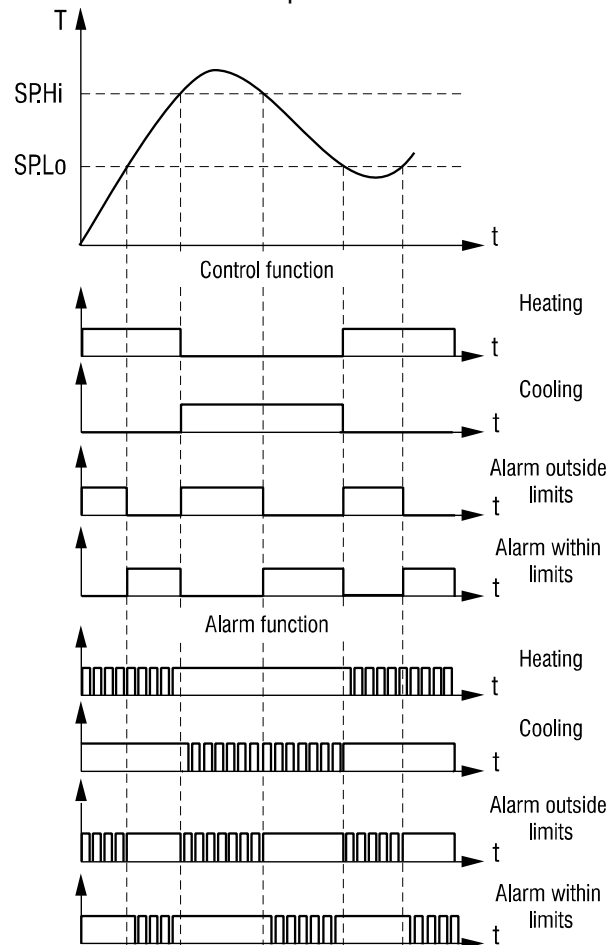

Fig. 6.1

Note:

Switching hysteresis: $0.05 \times (\text{SP.Hi} - \text{SP.Lo})$.

6.2 Alarm

If the control function **Cnt** is set and the alarm function **d.FnC** = ON, the display blinks with a frequency of about 2 Hz when the output is switched on (see Fig. 6.1).

6.3 Filter

Undesirable signal fluctuations can be suppressed through the adjustable filter in the parameter **td** "Filter time constant" (see Fig. 6.2 and Table 7.2).

The filter time constant can be set within the range 0...10 seconds. The higher the value, the slower the display reaction to changes of the input signal and the lower the susceptibility to interference is. The filter is deactivated if **td** = 0.

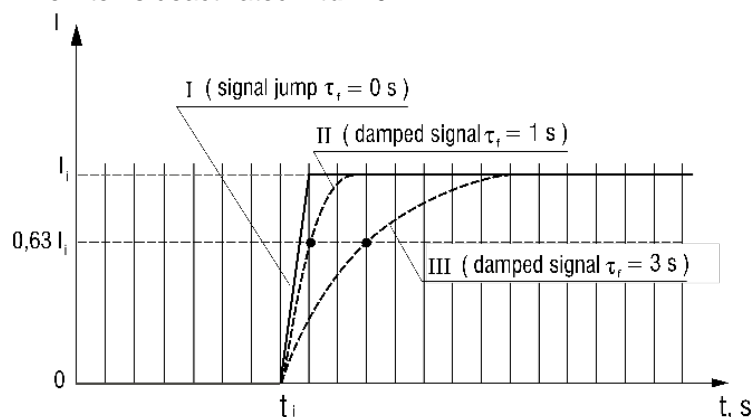

Fig. 6.2 Filter time constant

6.4 Square root function

The function is intended for transmitters with the square characteristic. To enable the function set the parameter **Sqrt** = ON.



6.5 Error



Table 6.1 Displayed errors

Display	Possible cause			Remedy
		Signal	Threshold	
<i>Er. 1</i>	Measured value error	-	-	Check the input signal. Check the sensor and connection lines. Contact the Technical Support of akYtec GmbH.
<i>LLLL</i>	Measured value is below the lower limit for the selected signal	0-5 mA	I < -0.2 mA	Check the input signal
		0-20 mA	I < -0.2 mA	
		4-20 mA	I < 3.8 mA	
		0-10 V	U < -0.1 V	
		2-10 V	U < 1.5 V	
<i>HHHH</i>	Measured value is above the upper limit for the selected signal	0-5 mA	I > 5.5 mA	Check the input signal
		0-20 mA	I > 22 mA	
		4-20 mA	I > 22 mA	
		0-10 V	U > 11 V	
		2-10 V	U > 11 V	
<i> ---- </i>	Wire break or short circuit (only for 4-20 mA and 2-10 V)	4-20 mA	I < 0.5 mA	Check the signal line
		2-10 V	U < 0.5 V	

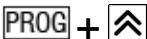
7 Programming

Table 7.1 Function buttons

Key	Description
	Press > 3 s: – enter the programming mode – exit the programming mode Press < 1 s: – save the parameter
	Press > 3 s: – enter the service menu
	Increase value or menu navigation
	Decrease value or menu navigation

- Press and hold the button  or  to activate the ramp function while changing parameter.

- if no button was pressed within 20 s, the device returns to the operating mode automatically.

Table 7.2 Programming parameters

Name	Display	Parameter	Valid value	Description	Default
SP.Lo	<i>SP.Lo</i>	Lower setpoint limit	-999...9999	affected by di.P	0
SP.Hi	<i>SP.Hi</i>	Upper setpoint limit	-999...9999	affected by di.P	30
Cnt	<i>Cnt</i>	Control function	oFF	OFF	U
			Heat	Heating	
			Cool	Cooling	
			U	Alarm outside limits	
			Π	Alarm within limits	
in.t	<i>in.t</i>	Input signal	See Table 2.2		0-10 V
td	<i>td</i>	Filter time constant	0...10 s		0
out.E	<i>out.E</i>	Output safe state	ON		OFF
			OFF		
di.Lo	<i>di.Lo</i>	Lower measuring limit	-999...9999	affected by di.P	0
di.Hi	<i>di.Hi</i>	Upper measuring limit	-999...9999	affected by di.P	100
SQrt	<i>SQrt</i>	Square root function	ON		OFF
			OFF		
di.P	<i>di.P</i>	Decimal point	----	0000	---.-
			---.-	000.0	
			--.00	00.00	
			-.000	0.000	
d.FnC	<i>d.FnC</i>	Alarm function	ON		OFF
			OFF		

Table 7.3 Service menu

Display	Comments	Valid values	
<i>rES</i>	Restore factory settings	0	User settings
		1	Factory settings
<i>CLbr</i>	Service function	-	
<i>SoFt</i>	Firmware version	-	

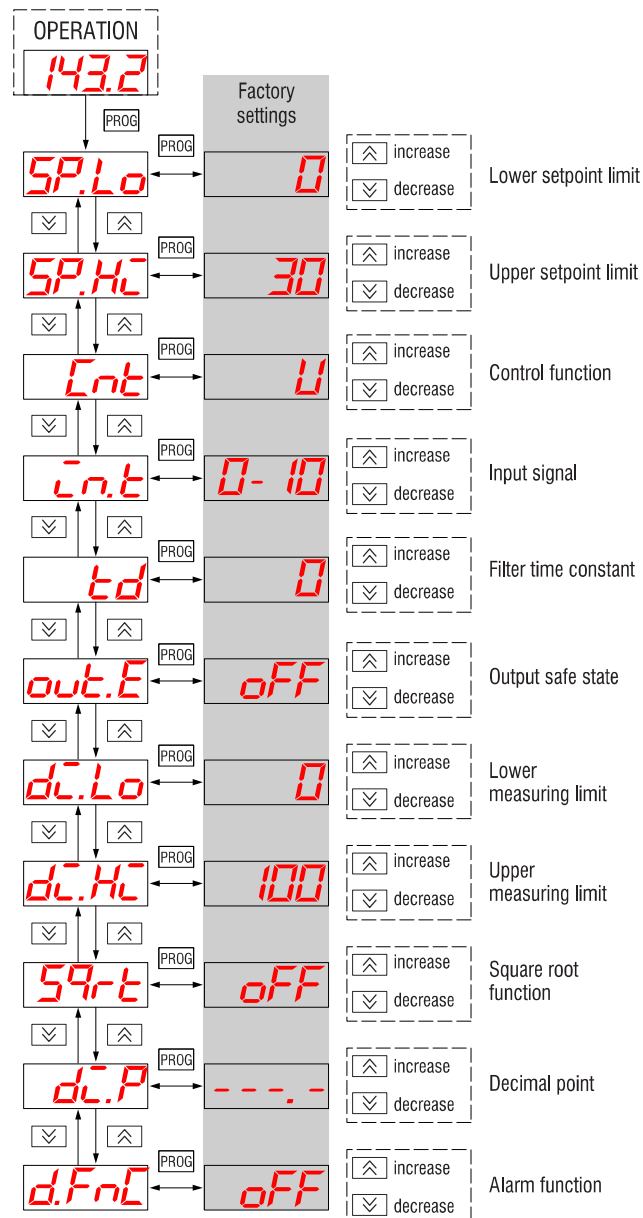

Fig. 7.1 Device menu

Note:

1. The minus sign is displayed in the most significant digit, together with 1. The display range is -199.9...999.9 if **di.P** = ---.-,
2. When setting the signal limits, take into account that in some cases the correct value cannot be displayed though there is no error indication.

Example 1:

di.Lo: -999 -> 4 mA **di.Hi:** 9999 -> 20 mA

For the input current of 3.8 mA the correct indication should be “-1068”. Actually “1068” will be displayed.

Example 2:

di.Lo: -999 -> 4 mA **di.Hi:** 9999 -> 20 mA

For the input current of 20.8 mA the correct indication should be “10548”. Actually “0548” will be displayed.

8 Maintenance

The maintenance includes:

- cleaning the housing and the terminals from dust, dirt and debris
- checking the fastening of the device
- checking the wiring (connecting leads, fastenings, mechanical damage)

The device should be cleaned with a damp cloth only. No abrasives or solvent-containing cleaners may be used.

9 Transportation and storage

Pack the device in such a way as to protect it reliably against impact for storage and transportation. The original packaging provides optimum protection.

If the device is not taken immediately after delivery into operation, it must be carefully stored at a protected location. The device should not be stored in an atmosphere with chemically active substances.

Permitted storage temperature: -25...+55 °C

► NOTICE

***The device may have been damaged during transportation.
Check the device for transport damage and completeness!
Report the transport damage immediately to the shipper and akYtec GmbH!***

10 Scope of delivery

- | | |
|----------------|---|
| – ITP14 | 1 |
| – Gasket | 1 |
| – Mounting nut | 1 |
| – User guide | 1 |

Appendix A. Dimensions

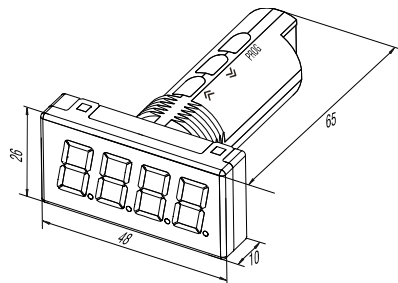

Fig. A1

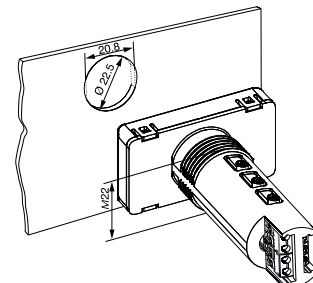

Fig. A2

To prevent the device spinning, the borehole in the front panel must correspond to the dimensions in Fig. A.2.