



**SUPERSTAR**

SARL au capital de 762 500 €

Route de Pagny

**21250 SEURRE - France**

TEL. 03 80 26 91 91 - FAX 03 80 26 91 00

E-mail : [superstar@crtfrance.com](mailto:superstar@crtfrance.com)

Web site : [www.crtfrance.com](http://www.crtfrance.com)



# CRT MICRON

## User Manual

### Dual band transceiver

144-146 MHz RX/TX

430-440 MHz RX/TX



Copyright CRT France 2017

**CRT**® and **SUPERSTAR**® are registered and protected brands.

# SYMBOLS DESCRIPTION

Please carefully read the instructions



Information on recycling, not throwing your material in the trash at the end of life,  
Bring it to special area to be recycling



DC using



Keep dry



Shield symbol



CE conformity symbol



Warning



## STORAGE , TRANSPORT, USING

---

*Storage : Classe 1 -30/85% (° Humidity)*

*Transport :- 30/85% (° Humidity )*

*operating temperature -30 à + 50°*

*Using cycle TX 10%/RX 90%*

The CRT MICRON UV HAM was approved in the followed countries that implement the CEPT regulation TR 61/01

AT,BE,BG,CH,CY,CZ,DE,DK,EE,FI,FR,GR,HR,HU,IE,IS,IT,LI,LT,LU,LV,MT,NL,NO,PL,PT,RO,SE,SI,SK,UK. ES



## **Warned before use**

Thank you for choosing this CRT vehicle transceiver CRT always provides high quality products. Though friendly design for user, this transceiver is technically complicated and some features may be new to you. Consider this manual to be a personal tutorial from the designers, allow the manual to guide you through the learning process now, then act as a reference in the coming years.

## **Precautions**



Please observe the following precautions to prevent fire, personal injury, or transceiver damage.



Do not attempt to configure your transceiver while driving, it is dangerous.



This transceiver is designed for a 13.8V DC power supply. Don't use a 24V battery to power on the transceiver.



Do not place the transceiver in excessively dusty, humid or wet areas, nor unstable surfaces.



Do not connect the antenna while transmission, risk of burn or electric shock.



Please keep it away from interferential devices (such as TV, generator etc.) devices (such as TV, generator etc.)



For those fitted with pacemakers are advised to move away from the antenna during transmission, mainly in high power, and especially do not touch it.



Never allow metal objects or son electrical contact with the part or internal electrical connection to the risk of electric shock.



Avoid exposing the transceiver to temperatures below  $-30^{\circ}\text{C}$ . and above  $+60^{\circ}\text{C}$ , the temperature of the dashboard inside a vehicle can sometimes exceed  $80^{\circ}\text{C}$ , which can damage irreparable damage to your machine in case of prolonged exposure. Not exposed to prolonged direct sunlight or place it near heaters.



Do not place anything on top of the apparatus that would interfere with cooling.



Check that your battery is sufficiently charged to avoid rapidly exhausting its resources.



It is important to turn off your device before starting the vehicle to avoid damage caused by spikes in the ignition.



When replacing the fuse, you must use a fuse 10A 250V type F  
In no case a higher value!, Otherwise a fire hazard.



If an abnormal odor or smoke is detected coming from the transceiver, turn OFF the power immediately.

Contact an CRT service station or your dealer.



Do not transmit with high output power for extended periods; the transceiver may overheat.



Keep out from children.

**Attention :**

- Before using your transceiver please connect an antenna on the connector PL on back side then check the SWR before emitting. A too important SWR can entail the destruction of the transistors of power which are not flatware by the guarantee

# CONTENTS

1.FUNCTIONS & FEATURES.....	1
2.ACCESSORIES .....	2
3.INITIAL INSTALLATION .....	3
4.GETTING ACQUAINTED.....	8
5.WORKING MODE .....	11
6.BASIC OPERATIONS.....	12
7.FUNCTION MENU .....	11
8.CHANNEL MENU .....	20
9.KEYPAD MENU SETUP .....	23
10.PROGRAMMING SOFTWARE.....	24
11.MAINTENANCE .....	25
12.SPECIFICATIONS.....	26
13.ATTACHED CHART.....	27

## 1. FUNCTIONS & FEATURES

CRT MICRON Mobile Radio has nice housing, stoutness & stability, advanced and reliable functions, perfect & valuable. This amateur mobile radio especially designs for drivers and it pursues philosophy of innovation and practicality. More functions as follows:

- ◆ Adopt superior quality material, better technology and high quality radiator to ensure stable and durable operation;
- ◆ 180 degree rotatable TFT LCD display;
- ◆ Full alloy body for heat radiation;
- ◆ Amateur mode and professional mode for different operation requirement;
- ◆ Distribute buttons reasonably, convenient for operation;
- ◆ Separate band width setting for each single channel, Wide 25K, Middle band 20K, Narrow band 12.5K;
- ◆ 200 programmable memory channels, identified by editing name;
- ◆ Separate CTCSS, DCS setting for each single channel, rejecting extra calling from other radios;
- ◆ Various scan functions including CTCSS/DCS Scan function;
- ◆ Smart menu control and PC programming control;
- ◆ Voltage level protection;
- ◆ LCD brightless control;
- ◆ Automatic power on function;
- ◆ Main unit and microphone key lock function.

## 2. ACCESSORIES

### 2.1 Standard Accessories

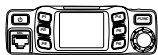

Transceiver



Microphone

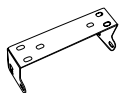

Mobile Bracket



DC Power Cable  
with Fuse Holder



Adjusting screws



Fuse(10A 250V)



manual

### 2.2 Optional Accessories



PC cable



External Speaker



Regulated Power Supply



Programming Software



Car Antenna



## 3. INITIAL INSTALLATION

### 3.1 Mobile Installation

To install the transceiver, select a safe, convenient location inside your vehicle that minimizes danger to your passengers and yourself while the vehicle is in motion. Consider installing the unit at an appropriate position so that knees or legs will not strike it during sudden braking of your vehicle. Try to pick a well ventilated location that is shielded from direct sunlight.

1. Install the mounting bracket in the vehicle using the supplied selftapping screws (2pcs) and flat washers (2pcs)

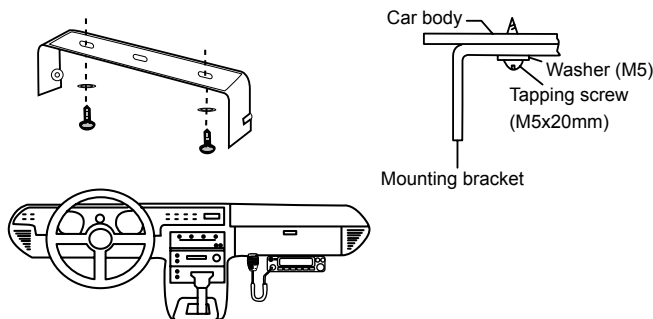

2. Position the transceiver, then insert and tighten the supplied hexagon SEMS screws.

- ◆ Double check that all screws are tightened to prevent vehicle vibration from loosening the bracket or transceiver.

### 3.2 DC Power Cable Connection

NOTE » Locate the power input connector as close to the transceiver as possible.

#### 3.2.1 Mobile Operation

The vehicle battery must have a nominal rating of 12V. Never connect the transceiver to a 24V battery. Be sure to use a 12V vehicle battery that has sufficient current capacity. If the current to the transceiver is insufficient, the display may darken during transmission, or transmitting output power may drop excessively.

1. Route the DC power cable supplied with the transceiver directly to the vehicle's battery terminals using the shortest path from the transceiver.
  - ◆ We recommend you do not use the cigarette lighter socket as some cigarette lighter sockets introduce an unacceptable voltage drop.
  - ◆ The entire length of the cable must be dressed so it is isolated from heat, moisture, and the engine secondary (high voltage) ignition system/ cables.
2. After installing cable, in order to avoid the risk of damp, please use heat-resistant tap to tie together with fuse box. Don't forget to reinforce whole cable.
3. In order to avoid the risk of short circuit, please cut down connection with negative (-) of battery, then connect with radio.
4. Confirm the correct polarity of the connections, then attach the power cable to the battery terminals; red connects to the positive (+) terminal and black connects to the negative (-) terminal.
  - ◆ Use the full length of the cable without cutting off excess even if the cable is longer than required. In particular, never remove the fuse holders from the cable.

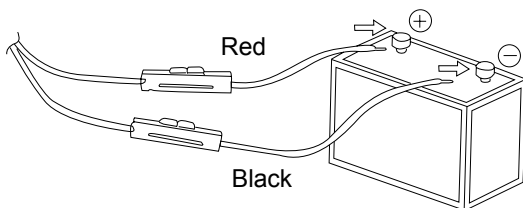

5. Reconnect any wiring removed from the negative terminal.
6. Connect the DC power cable to the transceiver's power supply connector.
  - ◆ Press the connectors firmly together until the locking tab clicks.

### 3.2.2 Fixed Station Operation

In order to use this transceiver for fixed station operation, you will need a separate 13.8V DC power supply (not included), power supply (QRP-01) as optional accessories. Please contact local dealer to require.

The recommended current capacity of your power supply is 12A.

1. Connect the DC power cable to the regulated DC power supply and ensure that the polarities are correct. (Red: positive, Black: negative).
  - ◆ Do not directly connect the transceiver to an AC outlet.
  - ◆ Use the supplied DC power cable to connect the transceiver to a regulated power supply.
  - ◆ Do not substitute a cable with smaller gauge wires.

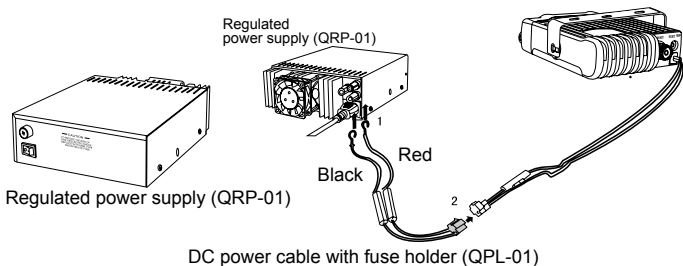

2. Connect the transceiver's DC power connector to the connector on the DC power cable.
- ◆ Press the connectors firmly together until the locking tab clicks.

**NOTE** » Before connecting the DC power to the transceiver, be sure to switch the transceiver and the DC power supply OFF.

» Do not plug the DC power supply into an AC outlet until you make all connections.

### 3.2.3 Replacing Fuses

If the fuse blows, determine the cause, then correct the problem. After the problem is resolved, replace the fuse. If newly installed fuses continue to blow, disconnect the power cable and contact your authorized **CRT** dealer or an authorized **CRT** servicecenter for assistance.

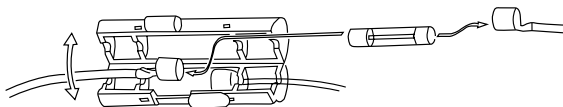

Fuse Location	Fuse Current Rating
Transceiver	10A
Supplied Accessory DC power cable	10A

Only use fuses of the specified type and rating, otherwise the transceiver could be damaged.

**NOTE** » If you use the transceiver for a long period when the vehicle battery is not fully charged, or when the engine is OFF, the battery may become discharged, and will not have sufficient reserves to start the vehicle. Avoid using the transceiver in these conditions.

### 3.3 Antenna Connection

Before operating, install an efficient, well-tuned antenna. The success of your installation will depend largely on the type of antenna and its correct installation. The transceiver can give excellent results if the antenna system and its installation are given careful attention.

Use a 50Ω impedance antenna and low-loss coaxial feed-line that has a characteristic impedance of 50Ω, to match the transceiver input impedance. Coupling the antenna to the transceiver via feed-lines having an impedance other than 50Ω reduces the efficiency of the antenna system and can cause interference to nearby broadcast television receivers, radio receivers, and other electronic equipment.

NOTE » Transmitting without first connecting an antenna or other matched load may damage the transceiver. Always connect the antenna to the transceiver before transmitting.

» All fixed stations should be equipped with a lightning arrester to reduce the risk of fire, electric shock, and transceiver damage.

The possible locations of antenna on a car are shown as following:

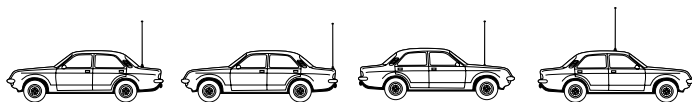

### 3.4 Accessories Connections

#### 3.4.1 External Speaker

If you plan to use an external speaker, choose a speaker with an impedance of 8Ω. The external speaker jack accepts a 3.5mm (1/8") mono (2-conductor) plug.

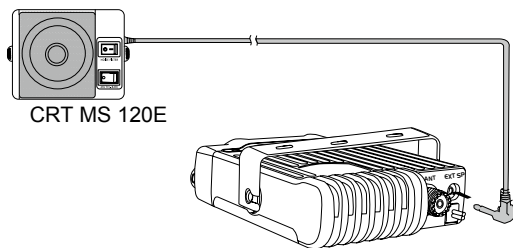

NOTE » External speaker adopt double port BTL, please care about the connecting way. The speaker can not connect with the ground, otherwise the speaker will be fault. The wrong connecting way as the following picture.

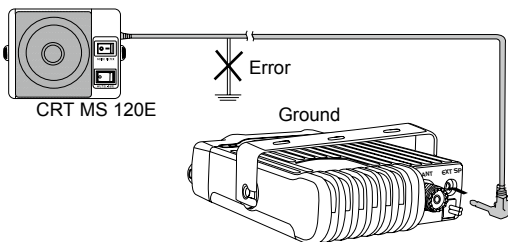

### 3.4.2 Microphone

For voice communications, connect a microphone equipped with an 8-pin modular plug into the modular socket on the front of the main unit. Press firmly on the plug until the locking tab clicks.

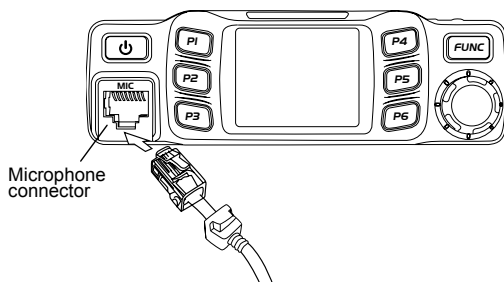

## 4. GETTING ACQUAINTED

### 4.1 Front panel

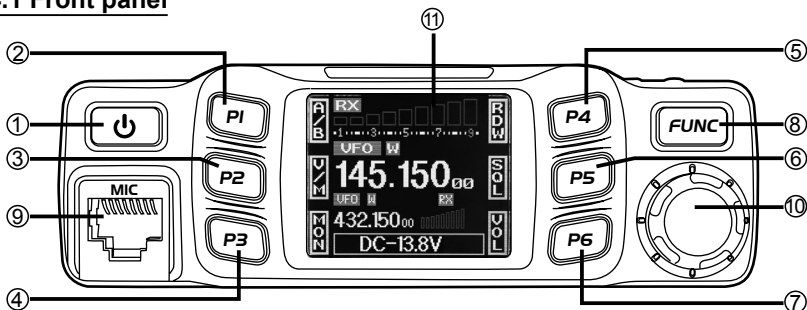

NO.	Key	Functions
1		Power On/Off/Mute
2		Self define key
3		Self define key
4		Self define key
5		Self define key
6		Self define key
7		Self define key
8		Function key/ function group key
9	MIC	Microphone Jack
10		Channel switch/Push button/Key lock
11	LCD display	Display channel/frequency/function setting

### 4.2 Rear panel

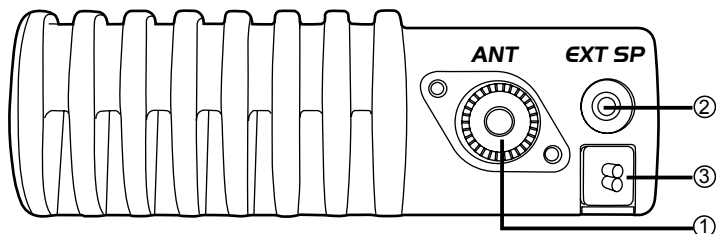

NO.	Key	Functions
1	Antenna connector	Connect a 50 ohm antenna
2	Ex-Speaker Jack	Connect optional SP-01 external speaker
3	Power cable	Connect a standard DC power cable

### 4.3 Display

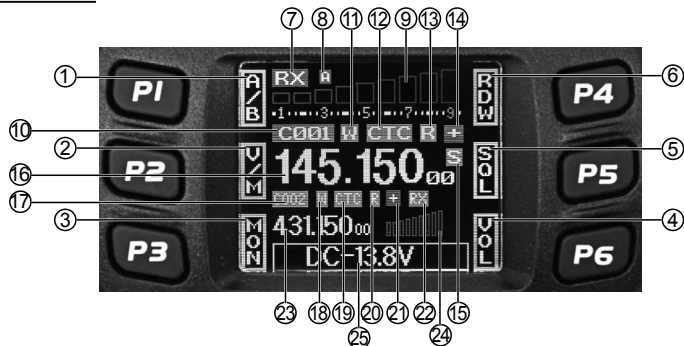

NO.	Functions
1	Displays the self define function when press P1
2	Displays the self define function when press P2
3	Displays the self define function when press P3
4	Displays the self define function when press P4
5	Displays the self define function when press P5
6	Displays the self define function when press P6
7	Displays the main channel TX or RX status
8	Displays when Automatic power off function is on
9	Displays the main channel field strength
10	Displays main channel number in channel mode
11	Displays when set band width for main channel
12	Displays when main channel set CTCSS/DCS
13	Displays when main channel reverse function is on
14	Displays when main channel offset function is on
15	Displays when main channel is in scan list
16	Displays main channel frequency or name
17	Displays sub channel number in channel mode
18	Displays when setting band width for sub channel
19	Displays when current sub channel set CTCSS/DCS
20	Displays when sub channel reverse function is ON
21	Displays when sub channel offset function is ON
22	Displays when sub channel receive a signal
23	Display sub channel frequency or name
24	Displays signal strength of sub channel
25	Display voltage and menu setting

## 4.4 Microphone

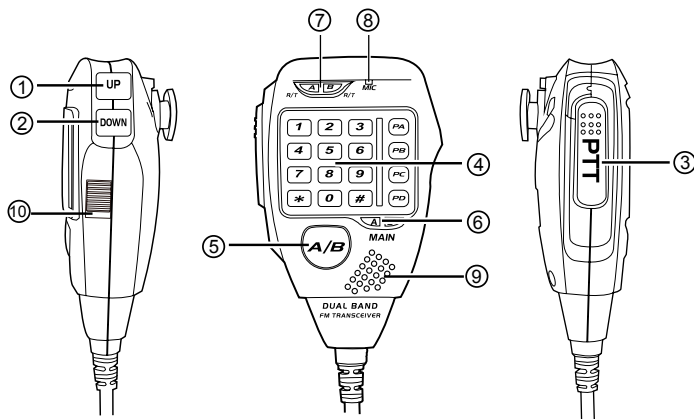

NO.	Key	Functions
1	UP	Increase frequency, channel number or setting value
2	DOWN	Decrease frequency, channel number or setting value
3	PTT	Press the PTT (Push-TO-Talk) key to transmit
4	Number Key	Input VFO frequency or DTMF dial out etc.
5	A/B band	Choose left band or right band as Main band
6	Band indicator	The indicator light on for Main band
7	TX/RX indicator	Light green while receiving, Light red while transmitting
8	MIC	Speak here during transmission
9	Speaker	When shut the speaker in the base, you can hear the calling by this speaker
10	Lock UP/DOWN	When this key is in up position, It is unlock UP/DOWN key, when this key is in down position, UP/DOWN key will be locked

MIC Connector Diagram(in the front view of connector)

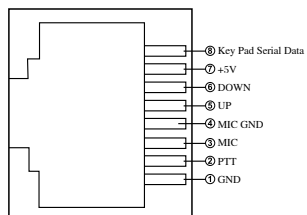



## 5. WORKING MODE (AMATEUR TRANSCEIVER OR CHANNEL MODE TRANSCEIVER)

According to practical application, you can set the radio works as Amateur Transceiver mode or Channel Transceiver mode. There are also 2 levels operation menu to set functions as you need. It is easy and convenient. FUNC MENU is for set background function, CHAN MENU for set channel function, MINI KEY menu for set self define key, HAND KEY for set self mic define key.

### 1. Working Mode:

A. By programming software: In PC software's "General Setting" menu, choose "Display Mode" to select Amateur Transceiver mode or Channel Transceiver mode.

B. By manual setup: Please refer to "Display Mode" in Page 16.

### 2. Amateur Transceiver Mode:

Except setting as "CH" mode, others considered as Amateur transceiver mode. Under this mode, press V/M matched PX key to switch between Channel mode and VFO mode.

A. Frequency+Channel mode: When set display as "FRQ", it enters into Frequency+Channel mode, new setting of channel operation and shortcut operation can be temporarily used by user. Once the radio is turned off or switched to another channel, the temporary setting will be erased and back to initial settings. (As pic 1)

B. Channel+Name Tag Mode: When set display as "NM", it enters into Channel +Name Tag mode. At this mode, it will display corresponding channel name when the current channel is edited with name. Otherwise, it will display frequency + channel. Its operations are same as frequency + channel mode. (As pic 2)

C. VFO Mode(Frequency mode): This mode shows only frequency on the display. Shortcut operation and Channel setting will be changed & stored as the latest value permanently. Once the radio is turned off or changed to new VFO frequency, the latest setting is remained until next change. (As pic 3)

### 3. Channel Transceiver Mode:

When set display mode as "CH", it enters into Channel Transceiver mode. If there is corresponding name for current channel, the LCD will display current channel name otherwise it current channel number. (As Pic 4)

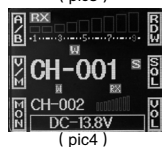
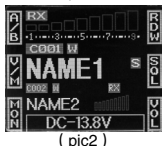
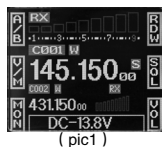



» If transceiver programmed as Channel transceiver mode and locked, you can't return to amateur transceiver mode by manual operation from general setting.

4. Under any mode, the FUNC MENU setting can be changed and saved.

## 6. BASIC OPERATIONS

### 6.1 Switching the Power On/Off

1. Power On: in power off state press , the LCD displays "WELCOME" then will displays current frequency or channel.
2. Power Off: in power on state, press  for 2 seconds, the LCD displays "CLOSING", then the LCD display disappears.

### 6.2 Adjusting the Volume

1. In standby mode, short press the [PX] key programmed as VOL control, the LCD display "VOL:XX", then turn the channel switch to adjust volume level.
2. In standby mode, short press to mute the speaker, the LCD display "AUDIO:MT", short press it again to return last volume level.

 » During communication, volume level can be adjusted more accurate.

NOTE

### 6.3 Adjusting Frequency

1. By channel knob: In VFO mode, turn channel knob can adjust frequency, push channel knob, the matching character will flash, then turn channel knob to adjust the frequency by step size 1K, 10K, 100K, 1Mz or 10MHz.

 » The microphone [UP]/[DOWN] key can also adjust the frequency, each press move one step size. hold the [DOWN] key can decrease one step size. if the channel knob is programmed as VOL function, users need press the PX key which programmed as FRQ function, when the LCD "VFO FREQ", turn channel knob to adjust frequency.

NOTE

2. By number key: In VFO mode, you can input wanted frequency by the microphone number key. For example if want 145.125Mhz, just press key 1, 4, 5, 1, 2, 5, if want 145Mhz, just press 1, 4, 5. The input is invalid if the frequency is over range.

### 6.4 Adjust Channel

1. Adjust channel by channel switch: In channel mode, turn channel knob to adjust the channel, the [UP]/[DOWN] key in the microphone can also adjust the main channel.

 » If there is an empty channel, the radio will jump over it to next channel. If the channel knob is programmed as VOL function, users need press the PX key which programmed as CH function, when the LCD displays "CH XX", turn channel knob to adjust channel.

NOTE

2. By number key: In CH mode, you can input wanted channel by the microphone input 3 numbers (001-200), 001 stands for channel 1, 200 stands for channel 200. if input channel is an empty channel, the radio will report error and return to last channel.

## 6.5 Receiving

When the channel you are operating being called, the screen shows red **RX** and field strength in this way you can hear the calling.

 » When the RX icon and field strength flashes, but can not hear the calling, it means current channel receive a matching carrier but unmatched signaling. Refer to CTCSS/DCS CODE or Optional Signaling setup in Page 14).  
NOTE

## 6.6 Transmitting

Hold [PTT] and speak into microphone. the radio start transmit, the screen shows red TX and field strength. Hold the microphone approximately 2.5-5.0cm from your lips and speak to microphone in your normal speaking voice to get best timbre.

 » Only available transmit on main channel.  
NOTE

## 6.7 Switch between Main Channel and Sub Channel

This radio work by single channel dual watch , in standby, the frequency in the upper side is main channel and down side is sub channel, the transmit is available only on main channel.

1. Short press [FUNC] to switch function group, choose the [PX] key defined as A/B function.
2. Short press [PX] key defined as A/B function, then repeatedly press this key or turn channel knob to switch main channel and sub channel, the LCD displays **Main:XX**.
3. Hold [PUSH] or [FUNC] key to store and exit, or wait 10 seconds the radio will store the setting and exit.

## 6.8 Switch between VFO and Channel Mode

1. Short press [FUNC] to switch function group, choose the [PX] key defined as V/M function.
2. Short press [PX] key defined as V/M function, then repeat press this key or turn channel knob to switch main channel and sub channel, the LCD displays **V/M:XX**.
3. Hold [PUSH] or [FUNC] key to store and exit, or wait 10 seconds the radio will store the setting and exit.

## 6.9 Channel Edit

1. In VFO mode, turn channel knob or the [UP]/[DOWN] key in microphone to adjust frequency.
2. Short press [FUNC] to switch function group, choose the [PX] key defined as CDT function. Press [PX] key defined as CDT function to set CTCSS/DCS code. turn channel knob or the [UP]/[DOWN] key in microphone to choose CTCSS/DCS code.
3. Long press [FUNC] key to enter channel setting menu, to choose wanted setting.
4. Short press [FUNC] key to switch function group, hold the [PX] key defined as V/M function until the channel number flashes, if the channel number is red means current channel is valid, if the channel number is green, means current channel is empty.
5. Turn the channel knob or microphone [UP]/[DOWN] key to choose the channel number to be stored.
6. Hold the [PX] key defined as V/M function to confirm and store the channel, the channel number stop flash and radio emits a beep sound, the channel is stored successfully.

## 6.10 Channel Delete

1. In channel mode, turn the channel knob or microphone [UP]/[DOWN] key to choose an unwanted channel.
2. Short press [FUNC] key to switch function group, choose the [PX] key defined as V/M function, press this key together with [FUNC] key for 2 seconds, current channel is deleted and automatic jump to next channel.

## 6.11 CTCSS/DCS Encode and Decode Setup

1. Short press [FUNC] to switch function group, choose the [PX] key defined as CDT function.
2. Short press PX defined as CDT function, then repeatedly short press this key can set the currently channel if use CTCSS/DCS encode and decode.
3. When the LCD displays: **RCDT:XXX**, turn channel knob or press microphone [UP]/[DOWN] key to choose if add CTCSS/DCS code to current channel. Press [PUSH] key then turn channel knob or press microphone [UP]/[DOWN] key to choose wanted CTCSS/DCS encode.
4. When the LCD displays: **TCDT:XXX**, turn channel knob or press microphone [UP]/[DOWN] key to choose if add CTCSS/DCS decode to current channel. Press [PUSH] then turn channel knob or press microphone [UP]/[DOWN] key to choose wanted CTCSS/DCS decode.
5. CTCSS: 62.5-254.1Hz plus one self define group. total 52 groups.  
DCS: 000N-777I total 1024 groups.  
N is positive code, I is inverse code.  
Press FUNC key can choose positive or inverse code.
6. Hold [PUSH] or [FUNC] key to store and exit, or wait 10 seconds the radio will automatically store the setting and exit.

 » *Under channel mode, this operation can be temporarily used by user. Once the radio is turned off or switched to another channel, the temporary setting will be erased. If the channel setting programmed for valid, the temporary setting will keep valid until next change, turn off radio or switch to another channel, the temporary setting will not changed.*

NOTE

## 6.12 CTCSS Scan

In channel or VFO mode, short press [FUNC] to switch function group, choose the [PX] key defined as CDT function. short press this key to enter CTCSS code setting. when the LCD displays **CTC**, long press this key to enter CTCSS scan. turn channel knob or press microphone [UP]/[DOWN] key can change scan direction. Once finding a matching CTCSS signaling, it will stop 5 seconds then scan again, short press any key to exit CTCSS scan.

## 6.13 DCS Scan

In channel or VFO mode, short press [FUNC] to switch function group, choose the [PX] key defined as CDT function. short press this key to enter DCS code setting. When the LCD displays **DCS**, long press this key to enter DCS scan, turn channel knob or press microphone [UP]/[DOWN] key can change scan direction. Once finding a matching DCS signaling, it will stop 5 seconds then scan again, press any key to exit DCS scan.

## 6.14 Frequency/Channel Scan

### **Frequency Scan**

In frequency (VFO) mode, this function is designed to monitor signal of all frequency points under each step size.

1. In VFO mode, short press [FUNC] key to switch function group, choose the [PX] key defined as SCN function.
2. Short press the [PX] key defined as SCN function to start frequency scan, the LCD displays "S".
3. Turn channel knob or press microphone [UP]/[DOWN] key can change scan direction.
4. Turn channel knob or press any key except microphone [UP]/[DOWN] key to exit.

### **Channel Scan**

In channel mode, this function is designed to monitor signal of all channel signal.

1. In channel mode, press [FUNC] key to switch function group, choose the [PX] key defined as SCN function.
2. Short press the [PX] key defined as SCN function to start channel scan, the LCD displays: **S**.
3. Turn channel knob or press microphone [UP]/[DOWN] key can change scan direction.
4. Turn channel knob or press any key except microphone [UP]/[DOWN] key to exit.

## 6.15 Scan Add/Delete

In channel mode, press [FUNC] key to switch function group, choose the [PX] key defined as SCN function. Hold this key to add into or delete from scan list.

1. When LCD displays:**S**, the current channel is in scan list.
2. When LCD not displays:**S**, the current channel is not in scan list.

## 6.16 Squelch off/ Squelch off Momentary

The [PX] key defined as MON function, can monitor the weak signal.

1. Press [FUNC] key to switch function group, choose the [PX] key defined as MON function.
2. Short press the [PX] key defined as MON function to turn squelch off / squelch off momentary, the LCD displays red "**RX**" icon.

Squelch off: press the [PX] key defined as MON to disable squelch, press [MON] key to resume squelch.

Squelch off momentary: hold the [PX] key defined as MON to disable squelch, release [MON] key to resume squelch.

 » *The above functions should be set in program software.*  
NOTE

## 6.17 KEYPAD LOCKOUT

Avoiding unintentional operation, this function will lock the keys except [PTT], [PUSH],  Keys.

1. Long press [PUSH] button, the downside of the LCD displays Key Lock, means the keypad is locked.
2. Long press [PUSH] again, the downside LCD displays : Key Unlock, means the keypad is unlocked.

## 7. FUNCTION MENU

1. Hold [FUNC] key to enter SELECT MENU interface.
2. Short press [P4], [P6] key or turn channel knob to choose menu list. Short press [P5] can fast turn page.
3. Press [PUSH] button to enter FUNC MENU setting.
4. Short press [P4], [P6] key or turn channel knob to choose wanted setting.

### 7.1 Beep

1. Enter FUNCTION MENU list, choose No.01 function.
2. Press [PUSH] button, the menu value in LCD turns to green color.
3. Turn channel knob to choose wanted setting.  
Off~5: 6 levels available.  
Off: Turn off BEEP function.
4. Press [PUSH] button or [P3] key to store setting and exit.

### 7.2 FREQUENCY STEP SETUP

1. Enter FUNCTION MENU list, choose No.02 function
2. Press [PUSH] button, the menu value in LCD turns to green color.
3. Turn channel knob to choose wanted setting.  
Total 9 Channel step size available: 2.5K,5K,6.25K,10K,12.5K,20K,25K, 30K and 50K.
4. Press [PUSH] button or [P3] key to store setting and exit.

### 7.3 Display mode setup

This radio has 3 different display: Frequency+Channel and Channel name Tag mode.

1. Enter FUNCTION MENU list, choose No.03 function.
2. Press [PUSH] button, the menu value in LCD turns to green color.
3. Turn channel knob to choose wanted setting.  
FRQ: Frequency+Channel mode(Amateur transceiver mode)  
CH: Channel mode(professional transceiver mode)  
NM: Channel+name mode+ Channel mode(Amateur transceiver mode), If channel not named, it display Fequency + Channel mode, otherwise displays the channel name(Amateur transceiver mode).
4. Press [PUSH] button or [P3] key to store setting and exit.

### 7.4 Squelch level Setup

This function use for setting RX signal strength, the calling will be heard only when reach setted level, otherwise the radio will keep mute.

1. Enter FUNCTION MENU list, choose No.04 function
2. Press [PUSH] button, the menu value in LCD turns to green color.
3. Turn channel knob to choose wanted setting.  
Off-9: Total 10 levels, OFF is lowest level, squelch is off
4. Press [PUSH] button or [P3] key to store setting and exit.

## **7.5 Volume level setting**

1. Enter FUNCTION MENU list, choose No.05 function
2. Press [PUSH] button, the menu value in LCD turns to green color.
3. Turn channel knob to choose wanted setting  
1-36: total 36 levels available
4. Press [PUSH] button or [P3] key to store setting and exit

## **7.6 Password setting**

After enable this function, must be input correct password then can turn on the transceiver.

1. Enter FUNCTION MENU list, choose No.06 function
2. Press [PUSH] button, the menu value in LCD turns to green color.
3. Turn channel knob to choose wanted setting  
ON: Turn on password function.  
OFF: Turn off password function
4. Press [PUSH] button or [P3] key to store setting and exit

## **7.7 Scan Dwell Time Setup**

1. Enter FUNCTION MENU list, choose No.07 function.
2. Press [PUSH] button, the menu value in LCD turns to green color.
3. Turn channel knob to choose wanted setting.  
TO: It pause for preset pause time when scanning a matching signal, then resume scan.  
CO: It pauses once scanning a matching signal, and resume scan when signal disappears.  
SE: It stops once scanning a matching signal.
4. Press [PUSH] button or [P3] key to store setting and exit.

## **7.8 Scan Pause Time Setup**

1. Enter FUNCTION MENU list, choose No.08 function
2. Press [PUSH] button, the menu value in LCD turns to green color.
3. Turn channel knob to choose wanted setting  
5S : It pauses 5s once scanning a matching signal, then resume scan  
10S : It pauses 10s once scanning a matching signal, then resume scan  
15S : It pauses 15s once scanning a matching signal, then resume scan
4. Press [PUSH] button or [P3] key to store setting and exit.

## **7.9 AOP (Automatic power on setup)**

When turn off AOP, the radio need press  key to power on when connect with the power supply.

1. Enter FUNCTION MENU list, choose No.09 function.
2. Press [PUSH] button, the menu value in LCD turns to green color.
3. Turn channel knob to choose wanted setting  
ON : Enable AOP function  
OFF: Power off by manual
4. Press [PUSH] button or [P3] key to store setting and exit.

## **7.10 Dual Watch setup**

1. Enter FUNCTION MENU list, choose No.10 function
2. Press [PUSH] button, the menu value in LCD turns to green color.
3. Turn channel knob to choose wanted setting  
ON: Enable Dual Watch function  
OFF: Disable Dual Watch function
4. Press [PUSH] button or [P3] key to store setting and exit.

## **7.11 Backlight Brightless Setup**

1. Enter FUNCTION MENU list, choose No.11 function
2. Press [PUSH] button, the menu value in LCD turns to green color.
3. Turn channel knob to choose brightless level, 1-3 level available.
4. Press [PUSH] button or [P3] key to store setting and exit.

## **7.12 TOT(Time Out Timer)**

The time-out timer limits continuous transmitting time. When transmit time last over programmed value, the transmitting will stop and emit a prompt.

1. Enter FUNCTION MENU list, choose No.12 function
2. Press [PUSH] button, the menu value in LCD turns to green color
3. Turn channel knob to choose wanted setting.  
1-30: 1-30 minutes range available by 1 minute/step  
OFF: Turn off TOT function
4. Press [PUSH] button or [P3] key to store setting and exit.

## **7.13 APO (Automatic Power OFF)**

Once APO is activated, the transceiver will be automatically switched off when the pre-set timer running out.

1. Enter FUNCTION MENU list, choose No.13 function
2. Press [PUSH] button, the menu value in LCD turns to green color.
3. Turn channel knob to choose wanted setting  
30Min: Automatical power off after 30 minutes.  
60Min: Automatical power off after 60 minutes.  
120Min: Automatical power off after 120 minutes  
OFF: Automatical power off function is off
4. Press [PUSH] button or [P3] key to store setting and exit

## **7.14 Pilot Frequency**

This function uses to start repeater. It needs a certain intensity Pilot Frequency to start dormant repeater. As usual, no need to send pilot frequency again once repeater started.

1. Enter FUNCTION MENU list, choose No.14 function
2. Press [PUSH] button, the menu value in LCD turns to green color.
3. Turn channel knob to choose wanted setting  
1000Hz: Pilot frequency 1000Hz  
1450Hz: Pilot frequency 1450Hz



1750Hz: Pilot frequency 1750Hz

2100Hz: Pilot frequency 2100Hz

4. Press [PUSH] button or [P3] key to store setting and exit.  
Push PTT+ UP key from microphone to send the tone burst

### **7.15 DIR (LCD display direction setup)**

1. Enter FUNCTION MENU list, choose No.15 function
2. Press [PUSH] button, the menu value in LCD turns to green color.
3. Turn channel knob to choose wanted setting  
FAIL: Revers display  
STAN: normal display
4. Press [PUSH] button or [P3] key to store setting and exit.

### **7.16 Microphone Speaker**

1. Enter FUNCTION MENU list, choose No.16 function
2. Press [PUSH] button, the menu value in LCD turns to green color
3. Turn channel knob to choose wanted setting.  
M&H: Turn on Main speaker and microphone speaker.  
MAIN: Turn on Main speaker.  
HAND: Turn on microphone speaker
4. Press [PUSH] button or [P3] key to store setting and exit

### **7.17 RTDF ( RX/TX dissimilar frequency Setup)**

This radio has dissimilar frequency function, when this function is on the frequency in upside of LCD is RX frequency, and the downside frequency is TX frequency. You can revise the RX frequency by numeric key in microphone, you can revise TX frequency by the A/B key in microphone or the PX key defined as A/B function.

1. Enter FUNCTION MENU list, choose No.17 function.
2. Press [PUSH] button, the menu value in LCD turns to green color.
3. Turn channel knob to choose wanted setting  
ON: Turn on RTDF function.  
OFF: Turn off RTDF function
4. Press [PUSH] button or [P3] key to store setting and exit.

 » *Only can turn on RTDF function in VFO mode..*  
NOTE

### **7.18 Reset Factory Default**

If you radio seems to be malfunctioning because of wrong operation or setup, this function will be able to resume all setup and channels to factory default.

1. Enter FUNCTION MENU list, choose No.18 function
2. Press [PUSH] button, the menu value in LCD turns to green color.
3. Turn channel knob to choose wanted setting  
ALL: All channel, signaling function setup resume factory default.  
OPT: All function menu setup resume factory default except for CHAN MENU.
4. Press [PUSH] button or [P3] key to store settint and exit

## 8. CHANNEL MENU

1. Hold [FUNC] key to enter SELECT MENU interface.
2. Short press [P4] key, [P6] key or turn channel knob to choose menu list. Short press [P5] key can fast turn page.
3. Press [PUSH] button to enter CHAN MENU list
4. Short press [P4],[P6] key or turn channel knob to choose wanted setting

### 8.1 RCDT (CTCSS/DCS Decode Setup)

1. Enter CHAN MENU, choose No.1 function
2. Press [PUSH] button, the menu value in LCD turns to green color.
3. Turn channel knob to choose wanted setting  
OFF: Turn off CTCSS/DCS decode.  
CTCSS: Choose CTCSS decode.  
DCS: Choose DCS decode.
4. When choose CTCSS/DCS decode, press [PUSH] button to enter CTCSS/DCS decode setup, then turn channel knob to choose wanted CTCSS/DCS decode.  
CTCSS: 62.5-254.1Hz, and one self- define group, total 52 groups  
DCS: 000N-777I, total 1024 groups  
N is positive code, I is inverse code.  
Press [FUNC] key can choose positive or inverse code
5. Press [PUSH] button or [P3] key to store setting and exit

 » *The working of CTCSS/DCS decode shall be work associated with the squelch mode setup. (Refer to Signaling Combination setup in page 21).*

### 8.2 CTCSS/DCS Encode Setup

1. Enter CHAN MENU, choose No.2 function
2. Press [PUSH] button, the menu value in LCD turns to green color.
3. Turn channel knob to choose wanted setting.  
OFF: Turn off CTCSS/DCS encode.  
CTCSS: Choose CTCSS encode.  
DCS: Choose DCS encode.
4. When choose CTCSS/DCS encode, press (PUSH) button to enter CTCSS/DCS encode setup, then turn channel knob to choose wanted CTCSS/DCS encode.  
CTCSS: 62.5-254.1HZ, and one self- define group, total 52 groups  
DCS: 000N-777I, total 1024 groups  
N is positive code, I is inverse code.
5. Press [PUSH] button or [P3] key to store setting and exit.

### 8.3 HIGH/MID/LOW Power Selection

1. Enter CHAN MENU, choose No.3 function
2. Press [PUSH] button, the menu value in LCD turns to green color

3. Turn channel knob to choose wanted setting  
HI: Choose high power level.  
MI: Choose middle power level.  
LO: Choose low power level.
4. Press [PUSH] button or [P3] key to store setting and exit

## **8.4 Signaling Combination Setup**

This function can improve the level of blocking irrelative signals.

1. Enter CHAN MENU, choose No.4 function
2. Press [PUSH] button, the menu value in LCD turns to green color.
3. Turn channel knob to choose wanted setting.  
SQ: You can hear the calling when receive a matching carrier.  
CDT: You can hear the calling when receive a matching carrier and CTCSS or DCS signaling
4. Press [PUSH] button or [P3] key to store setting and exit.

 » *This setting is valid only when CTCSS/DCS signaling added.*  
NOTE

## **8.5 Band-width Selection**

Select suitable bandwidth in accordance with different local conditions

1. Enter CHAN MENU list, choose No.5 function
2. Press [PUSH] button, the menu value in LCD turns to green color.
3. Turn channel knob to choose wanted setting.  
WID: band width is 25k(Wide band)  
MID: band width is 20k(Middle band)  
NAR: band width is 12.5k(Narrow band)
4. Press [PUSH] button or [P3] key to store setting and exit.

## **8.6 Frequency Reverse**

With this function on, the transceiver will be able to communicate with a transceiver in same network without through a repeater..

1. Enter CHAN MENU list, choose No.6 function
2. Press [PUSH] button, the menu value in LCD turns to green color.
3. Turn channel knob to choose wanted setting.  
ON: Turn on reverse function  
OFF: Turn off reverse function
4. Press [PUSH] button or [P3] key to store setting and exit

 » *Frequency reverse is turn on, the TX and RX frequency will be exchanged, the CTCSS or DCS signaling also will be exchanged if existed in current channel.*  
NOTE

## **8.7 Talk Around**

1. Enter CHAN MENU list, choose No.7 function
2. Press [PUSH] button, the menu value in LCD turns to green color.
3. Turn channel knob to choose wanted setting  
ON: Turn on talk around function  
OFF: Turn off talk around function
4. Press PUSH button or P3 key to store setting and exit.

 » *This function is hide when RTDF function is on.*  
NOTE

## **8.8 Offset Frequency And Direction Setup**

1. Enter CHAN MENU list, choose No.8 function
2. Press [PUSH] button, the menu value in LCD turns to green color.
3. Turn channel knob to choose wanted setting, press [FUNC] key to set the offset direction..  
-: Minus offset, means transmitting frequency lower than receiving frequency.  
+: Plus offset, means transmitting frequency higher than receiving frequency.  
OFF: OFFSET is turn off.  
VHF: 0 - 38 Mhz frequency available.  
UHF: 0 - 90 Mhz frequency available.
4. Press [PUSH] button or [P3] key to store setting and exit.

 » *OFFSET frequency is adjusted according to step size setup. This function is hide when RTDF function is on.*  
NOTE

## **8.9 Editing Channel Name**

After edit a name for a channel, if the display mode is channel name, the radio will display the name edited in this menu. Otherwise it will display the frequency.

1. Enter CHAN MENU list, choose No.9 function
2. Press [PUSH] button, the menu value in LCD turns to green color.
3. Turn channel knob to choose wanted setting. Press [PUSH] to confirm and enter editing for next character.
4. Press [PUSH] button or [P3] key to store setting and exit.

 » *In Frequency (VFO) mode or RTDF function is on..this function will be auto-hidden.*  
NOTE

## **8.10 Busy Channel Lockout**

Busy channel lockout is disable transmitting, once the channel is busy and you press [PTT], the radio will beep as warning and get back to receiving.

1. Enter CHAN MENU list, choose No.10 function
2. Press [PUSH] button, the menu value in LCD turns to green color.
3. Turn channel knob to choose wanted setting.  
BU: Signaling busy lockout, transmitting is inhibited when current channel receives a matching carrier.

RL: Signaling busy lockout, transmitting is inhibited when current channel receives a matching carrier but dis-matching CTCSS/DCS code.

OFF: Busy channel lockout is disabled. Transmitting is allowed in any receiving status

4. Press [PUSH] button or [P3] key to store setting.

## **8.11 TX OFF**

1. Enter CHAN MENU list, choose No.11 function
2. Press [PUSH] button, the menu value in LCD turns to green color.
3. Turn channel knob to choose wanted setting.  
ON: TX allowed, press [PTT] to transmit  
OFF: TX not allowed, only work in RX mode, press [PTT] will emit a beep.
4. Press [PUSH] button or [P3] key to store setting and exit

## **9. KEYPAD MENU SETUP**

### **9.1 Main unit keypad menu setup**

1. Hold [FUNC] key to enter SELECT MENU interface.
2. Short press [P4] key, [P6] key or turn channel knob to choose menu list. Press [P5] can fast turn page.
3. Press [PUSH] to enter MINI KEY menu list.
4. Turn channel knob to choose wanted setting.
5. Short press [PUSH] button to choose wanted keypad group .
6. Short press [P1]~[P6] key to choose wanted self-define key. Short press [FUNC] to confirm and exit.

### **9.2 H-DIM Microphone keypad backlight setup**

1. Hold [FUNC] key to enter SELECT MENU interface.
2. Short press [P4] key, [P6] key or turn channel knob to choose menu list. Press [P5] can fast turn page.
3. Press [PUSH] button to enter HANDY KEY menu list.
4. Short press [P4] key, [P6] key or turn channel knob to choose wanted setting.

### **9.3 Microphone keypad backlight brightness Setup**

1. Hold [FUNC] key to enter SELECT MENU interface.
2. Short press [P4] key, [P6] key or turn channel knob to choose menu list. Short press [P5] key can fast turn page.
3. Press [PUSH] button to enter HAND KEY menu list, choose No.1 function, press [PUSH] key to enter value setting, the menu value in LCD turns to green color.
4. Turn channel knob to choose wanted setting, the microphone keypad has OFF-31, total 32 brightness levels. OFF means turn off backlight brightness.
5. Press [PUSH] key or [P3] key to store setting and exit..

## **9.4 H-PA H-PD Microphone self-define keypad setup**

1. Hold [FUNC] key to enter SELECT MENU interface
2. Short press [P4] key, [P6] key or turn channel knob to choose menu list. Press [P5] can fast turn page.
3. Press [PUSH] button to enter HANDY KEY menu list. choose NO.2-5 function, then press [PUSH] button to enter value setting. the menu value in LCD turns to green color
4. Turn channel knob to choose wanted setting.
5. Press [PUSH] button or [P3] key to store setting and exit.

## **10. PROGRAMMING SOFTWARE INSTALLING AND STARTING SOFTWARE I**

### **Install USB Cable Driver Programme**

1. Click start menu in computer, under "ALL PROGRAMS" menu, choose and click "USB To Com port" in CRT MICRON program, install "USB To Com port" driver by indication.
2. Connect the optional PC51 USB Programming cable to USB port in PC with transceiver.
3. Double click CRT MICRON shortcut or click MICRON in procedure index of start menu, choose serial com port as indicated then click OK to start programming software.
4. According to instruction, select correct "COM Port", then click "OK" to start programming software.

 » *Even in same computer, the selective COM Port is different when USB cable connects with different USB port*

You shall install software before connecting the USB cable line. Switch on transceiver before writing frequency. You had better not switch on or off the power supply of transceiver when it is connected with computer, otherwise, it will make transceiver unable to read or write frequency. In this case, you have to turn off programming software, pull out USB cable. then reinsert USB cable and open software, then rechoose COM Port, it will turn into normal operation. Therefore, please connect transceiver with computer after switching on the transceiver. Don't restart transceiver power when it is connected with computer.

# 11. MAINTENANCE

## 11.1 Default Setting after Resetting

Frequency band	VHF	UHF
VFO frequency	145.150MHz	431.150MHz
Memory channel	--	--
Offset direction	--	--
Offset frequency	600KHz	5MHz
Channel step	10KHz	10KHz
CTCSS encode and decode	--	--
CTCSS tone frequency	88.5Hz	88.5Hz
DCS encode and decode	--	--
DCS Code	000N	000N
Output power	HI	HI
TOT	3	3
APO	OFF	OFF
VOL	28	28
Squelch Level	3	3

## 11.2 Trouble Shooting

Problem	Possible Causes and Potential Solutions
(1) Power is on, nothing appears on Display	+ and - polarities of power connection are reversed. Connect red lead to plus terminal and black lead to minus terminal of DC power supply
(2) Fuse is blown	Check and solve problem resulting in blown fuse and replace fuse with new fuse
(4) No sound comes from speaker	<ul style="list-style-type: none"><li>• Squelch is muted. Decrease squelch level.</li><li>• Tone or CTCSS/DCS squelch is active. Turn CTCSS or DCS squelch off</li></ul>
(5) Key and Dial do not function	Key-lock function is activated. Cancel Key-lock function
(6) No Scan	Did not list the channel in the scan when programmed
The whole band with noise after programmed	The squelch has opened during programmed
Communication range was short, bad sensitivity	<ul style="list-style-type: none"><li>a. Check the antenna is well or not, and check the antenna port whether well connected.</li><li>b. Antenna connector has debris or damaged. Whether set Low power</li></ul>
Can not talk with other members within the group	<ul style="list-style-type: none"><li>a. Frequency/channel different, pls modify</li><li>b. CTCSS/DCS different, pls reset</li><li>c. Out of the communication range</li></ul>

## 12. SPECIFICATIONS

GENERAL	
Frequency Range	VHF: 144-146MHz UHF: 430~440MHz
Number of Channels	200 channels
Channel Spacing	25K (Wide Band) 20K(Middle Band) 12.5K (Narrow band)
Phase-locked Step	2.5KHz, 5KHz, 6.25KHz, 10KHz, 12.5KHz, 20KHz, 25KHz, 30KHz, 50KHz
Operating Voltage	13.8V DC $\pm$ 15%
Squelch	Carrier/CTCSS/DCS
Frequency Stability	$\pm$ 2.5 ppm
Operating Temperature	-20°C~+60°C
Dimensions(mm)	124 (W) x 163(D) x 39 (H)
Weight	about 0.64Kg

☞ » *Specifications are subject to change without notice due to advancements in technology.*

RECEIVER		
	Wide band	Narrow band
Sensitivity (12dB Sinad)	$\leq$ 0.25 $\mu$ V	$\leq$ 0.35 $\mu$ V
Adjacent Channel Selectivity	$\geq$ 60dB	$\geq$ 60dB
Audio Response	+1~-3dB(0.3~3KHz)	+1~-3dB(0.3~2.55KHz)
Hum & Noise	$\geq$ 45dB	$\geq$ 40dB
Audio distortion	$\leq$ 5%	
Audio power output	$>$ 2W@8	

TRANSCEIVER		
	Wide band	Narrow band
Power Output	25W / 15W / 5W	
Modulation	16K $\Phi$ F3E	11K $\Phi$ F3E
Adjacent Channel Power	$\geq$ 70dB	$\geq$ 60dB
Hum & Noise	$\geq$ 40dB	$\geq$ 36dB
Spurious Emission	$\geq$ 60dB	$\geq$ 60dB
Audio Response	+1~-3dB(0.3~3KHz)	+1~- 3dB(0.3~2.55KHz)
Audio Distortion	$\leq$ 5%	



## 13. ATTACHED CHART

### 52 groups CTCSS Tone Frequency(Hz)

No.	Freq.(Hz)	No.	Freq.(Hz)	No.	Freq. (Hz)	No.	Freq. (Hz)	No.	Freq. (Hz)
1	62.5	12	94.8	23	136.5	34	177.3	45	218.1
2	67.0	13	97.4	24	141.3	35	179.9	46	225.7
3	69.3	14	100.0	25	146.2	36	183.5	47	229.1
4	71.9	15	103.5	26	151.4	37	196.2	48	233.6
5	74.4	16	107.2	27	156.7	38	189.9	49	241.8
6	77.0	17	110.9	28	159.8	39	192.8	50	250.3
7	79.7	18	114.8	29	162.2	40	196.6	51	254.1
8	82.5	19	118.8	30	165.5	41	199.5	52	Self-define
9	85.4	20	123.0	31	167.9	42	203.5		
10	88.5	21	127.3	32	171.3	43	206.5		
11	91.5	22	131.8	33	173.8	44	210.7		

## 1024 groups DCS Code

Code No.	DSC (Octal)	Code No.	DSC (Octal)	Code No.	DSC (Octal)	Code No.	DSC (Octal)	Code No.	DSC (Octal)	Code No.	DSC (Octal)	Code No.	DSC (Octal)	Code No.	DSC (Octal)
1.	000	2.	001	3.	002	4.	003	5.	004	6.	005	7.	006	8.	007
9.	010	10.	011	11.	012	12.	013	13.	014	14.	015	15.	016	16.	017
17.	020	18.	021	19.	022	20.	023	21.	024	22.	025	23.	026	24.	027
25.	030	26.	031	27.	032	28.	033	29.	034	30.	035	31.	036	32.	037
33.	040	34.	041	35.	042	36.	043	37.	044	38.	045	39.	046	40.	047
41.	050	42.	051	43.	052	44.	053	45.	054	46.	055	47.	056	48.	057
49.	060	50.	061	51.	062	52.	063	53.	064	54.	065	55.	066	56.	067
57.	070	58.	071	59.	072	60.	073	61.	074	62.	075	63.	076	64.	077
65.	100	66.	101	67.	102	68.	103	69.	104	70.	105	71.	106	72.	107
73.	110	74.	111	75.	112	76.	113	77.	114	78.	115	79.	116	80.	117
81.	120	82.	121	83.	122	84.	123	85.	124	86.	125	87.	126	88.	127
89.	130	90.	131	91.	132	92.	133	93.	134	94.	135	95.	136	96.	137
97.	140	98.	141	99.	142	100.	143	101.	144	102.	145	103.	146	104.	147
105.	150	106.	151	107.	152	108.	153	109.	154	110.	155	111.	156	112.	157
113.	160	114.	161	115.	162	116.	163	117.	164	118.	165	119.	166	120.	167
121.	170	122.	171	123.	172	124.	173	125.	174	126.	175	127.	176	128.	177
129.	200	130.	201	131.	202	132.	203	133.	204	134.	205	135.	206	136.	207
137.	210	138.	211	139.	212	140.	213	141.	214	142.	215	143.	216	144.	217
145.	220	146.	221	147.	222	148.	223	149.	224	150.	225	151.	226	152.	227
153.	230	154.	231	155.	232	156.	233	157.	234	158.	235	159.	236	160.	237
161.	240	162.	241	163.	242	164.	243	165.	244	166.	245	167.	246	168.	247
169.	250	170.	251	171.	252	172.	253	173.	254	174.	255	175.	256	176.	257
177.	260	178.	261	179.	262	180.	263	181.	264	182.	265	183.	266	184.	267
185.	270	186.	271	187.	272	188.	273	189.	274	190.	275	191.	276	192.	277
193.	300	194.	301	195.	302	196.	303	197.	304	198.	305	199.	306	200.	307
201.	310	202.	311	203.	312	204.	313	205.	314	206.	315	207.	316	208.	317
209.	320	210.	321	211.	322	212.	323	213.	324	214.	325	215.	326	216.	327
217.	330	218.	331	219.	332	220.	333	221.	334	222.	335	223.	336	224.	337
225.	340	226.	341	227.	342	228.	343	229.	344	230.	345	231.	346	232.	347
233.	350	234.	351	235.	352	236.	353	237.	354	238.	355	239.	356	240.	357
241.	360	242.	361	243.	362	244.	363	245.	364	246.	365	247.	366	248.	367
249.	370	250.	371	251.	372	252.	373	253.	374	254.	375	255.	376	256.	377
257.	400	258.	401	259.	402	260.	403	261.	404	262.	405	263.	406	264.	407
265.	410	266.	411	267.	412	268.	413	269.	414	270.	415	271.	416	272.	417
273.	420	274.	421	275.	422	276.	423	277.	424	278.	425	279.	426	280.	427
281.	430	282.	431	283.	432	284.	433	285.	434	286.	435	287.	436	288.	437
289.	440	290.	441	291.	442	292.	443	293.	444	294.	445	295.	446	296.	447
297.	450	298.	451	299.	452	300.	453	301.	454	302.	455	303.	456	304.	457
305.	460	306.	461	307.	462	308.	463	309.	464	310.	465	311.	466	312.	467

313.	470	314.	471	315.	472	316.	473	317.	474	318.	475	319.	476	320.	477
321.	500	322.	501	323.	502	324.	503	325.	504	326.	505	327.	506	328.	507
329.	510	330.	511	331.	512	332.	513	333.	514	334.	515	335.	516	336.	517
337.	520	338.	521	339.	522	340.	523	341.	524	342.	525	343.	526	344.	527
345.	530	346.	531	347.	532	348.	533	349.	534	350.	535	351.	536	352.	537
353.	540	354.	541	355.	542	356.	543	357.	544	358.	545	359.	546	360.	547
361.	550	362.	551	363.	552	364.	553	365.	554	366.	555	367.	556	368.	557
369.	560	370.	561	371.	562	372.	563	373.	564	374.	565	375.	566	376.	567
377.	570	378.	571	379.	572	380.	573	381.	574	382.	575	383.	576	384.	577
385.	600	386.	601	387.	602	388.	603	389.	604	390.	605	391.	606	392.	607
393.	610	394.	611	395.	612	396.	613	397.	614	398.	615	399.	616	400.	617
401.	620	402.	621	403.	622	404.	623	405.	624	406.	625	407.	626	408.	627
409.	630	410.	631	411.	632	412.	633	413.	634	414.	635	415.	636	416.	637
417.	640	418.	641	419.	642	420.	643	421.	644	422.	645	423.	646	424.	647
425.	650	426.	651	427.	652	428.	653	429.	654	430.	655	431.	656	432.	657
433.	660	434.	661	435.	662	436.	663	437.	664	438.	665	439.	666	440.	667
441.	670	442.	671	443.	672	444.	673	445.	674	446.	675	447.	676	448.	677
449.	700	450.	701	451.	702	452.	703	453.	704	454.	705	455.	706	456.	707
457.	710	458.	711	459.	712	460.	713	461.	714	462.	715	463.	716	464.	717
465.	720	466.	721	467.	722	468.	723	469.	724	470.	725	471.	726	472.	727
473.	730	474.	731	475.	732	476.	733	477.	734	478.	735	479.	736	480.	737
481.	740	482.	741	483.	742	484.	743	485.	744	486.	745	487.	746	488.	747
489.	750	490.	751	491.	752	492.	753	493.	754	494.	755	495.	756	496.	757
497.	760	498.	761	499.	762	500.	763	501.	764	502.	765	503.	766	504.	767
505.	770	506.	771	507.	772	508.	773	509.	774	510.	775	511.	776	512.	777



**DECLARATION OF CONFORMITY**

**CE0700**

We hereby declare under our responsibility that the product :

Brand Name : CRT

Model : MICRON U/V

144-146 MHz/430-440 Mhz HAM Radio

Satisfies all the technical regulations applicable to the product within the scope of  
directive : RED 2014/30/UE and following norms.

EN 60950-1 :2006+A11 :2009+A1 :2010+A12 :2011+A2 :2013

EN 301 489-1

EN 301 489-15

EN 301 783-1

EN 301 783-2

EN 62133

Notified Body : PHOENIX TESTLAB GmbH Germany

The was approved in the CEPT  
countries and those non CEPT countries  
that implement the CEPT regulation TR 61/01

C.R.T. FRANCE INTERNATIONAL S.A.R.L.  
Route de Pagny - 21250 SEURRE - FRANCE  
Capital de 762 500 euros  
Tél. 03 80 26 91 91 - Fax : 03 80 26 91 00  
E-mail : superstar@crtfrance.com  
Web site : www.crtfrance.com

Mr CELESTRANO PHILIPPE  
MANAGER

LE 22/06/2017



**RoHS**  
compliant

## **CONDITIONS OF GUARANTEE**

Our transceivers CRT SUPERSTAR are guaranteed on 2 year. The other equipments: 6 months.

Any abnormality of functioning must be indicated to your retailer, who will intervene or will send it to our technical service for control.

The spare parts of our devices are the object of no sending under guarantee.

Are excluded of the guarantee:

- The damages caused by accidents, shocks, natural elements (lightning, thunderstorm, static electricity etc.)
- The transistors of power, the microphones, the fuses, the bad uses: badly adjusted antenna (too excessive), inversion of polarity, surge, bad connection etc. recognized by our technical service.
- The interventions having modified the standards of approval of the device.

## **PROCEDURE ON RETURNING TO THE AFTER-SALES SERVICE CRT**

- If you send back a radio under guarantee for repair: You must pay the freight costs to go. CRT will pay the freight costs return.

If the radio is not under guarantee postal charges are at your expense.

- Each device must be sent accompanied with a photocopy of the invoice as well as with a descriptive note of the noticed defect.

If our AFTER-SALES SERVICE estimates the repair more expensive than the value of the device, this one will send you an estimate which must have returned to him accepted or refused. If the estimate is refused, the device will have carriage forward return.