

# SN·MP-PC SERIES

## SN · MP-PC BATTERY HOLDER FOR THROUGH HOLE

**SN 3-1PC**

AA cell×1

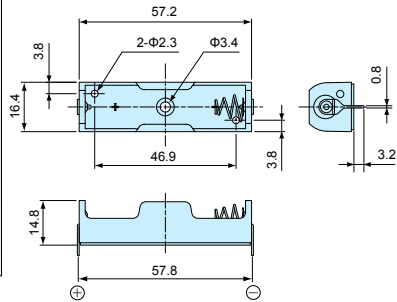

**SN 3-2PC**

AA cell×2

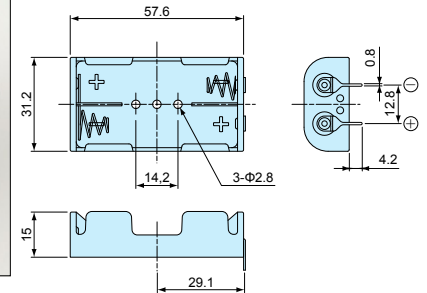

**SN 3-3PC**

AA cell×3

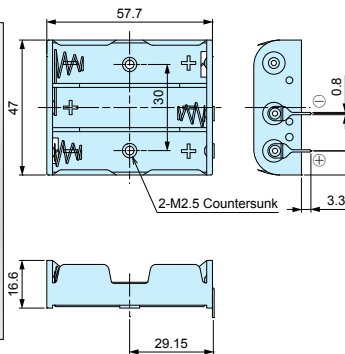

**SN 3-4PC**

AA cell×4

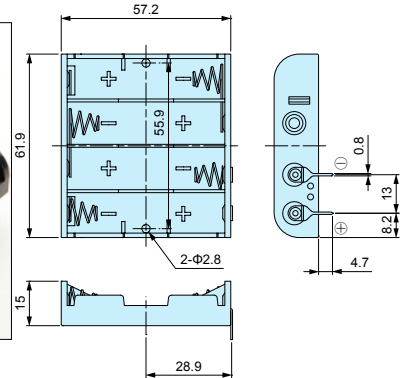
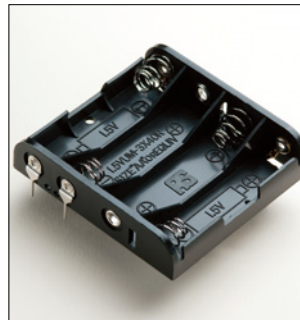

**MP-4-1PC**

AAA cell×1

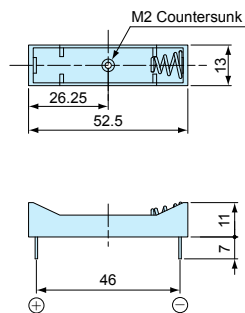

**SN 4-2PC**

AAA cell×2

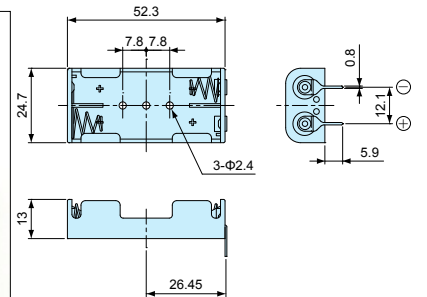

### Components

Holder material	Spring / Finish	Terminal / Finish	P.C pin
PP / PE / ABS	Steel / Nickel plating	Brass / Nickel plating	Steel Ni plating / Steel Sn Plating











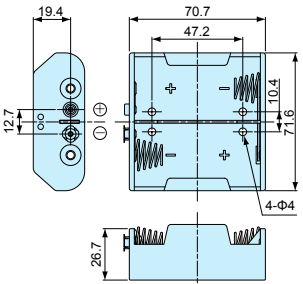

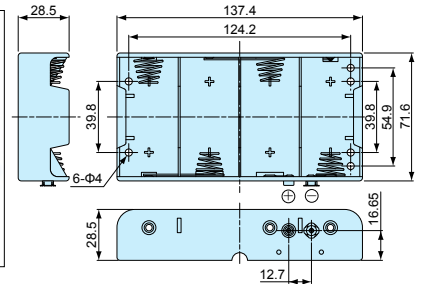
### Part no.

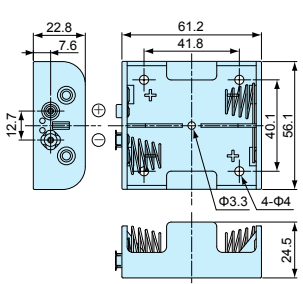
Part no.	Battery	Holder material	P.C pin / Finish	Weight(g)
SN 3-1PC	AA (UM3) × 1	PP	Steel / nickel plating	3.6
SN 3-2PC	AA (UM3) × 2	PE	Steel / nickel plating	7.0
SN 3-3PC	AA (UM3) × 3	PP	Steel / nickel plating	9.4
SN 3-4PC	AA (UM3) × 4	PP	Steel / nickel plating	11.5
MP-4-1PC	AAA (UM4) × 1	ABS	Steel / Sn plating	2.5
SN 4-2PC	AAA (UM4) × 2	PP	Steel / nickel plating	4.5

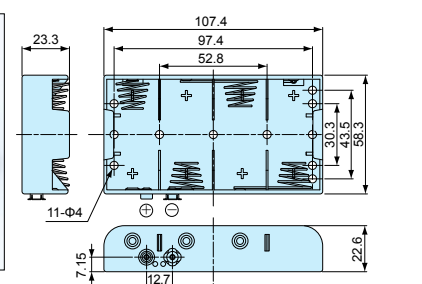
# SN-S SERIES

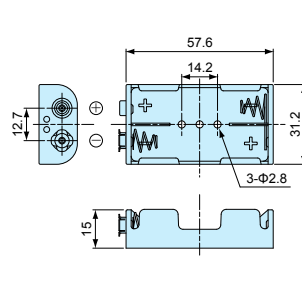
## SN-S BATTERY HOLDER WITH SNAP TERMINAL

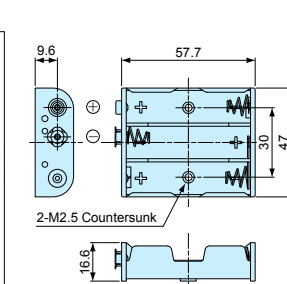
• Recommended to use with MP battery snap.

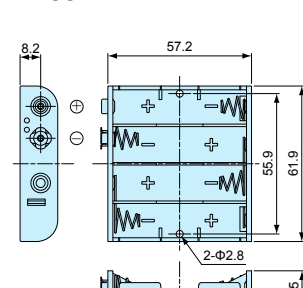
<b>SN 1-2S</b>	D cell×2	<b>SN 1-4S</b>	D cell×4
			
<b>SN 2-2S</b>	C cell×2	<b>SN 2-4S</b>	C cell×4
			
<b>SN 3-2S</b>	AA cell×2	<b>SN 3-3S</b>	AA cell×3
			
<b>SN 3-4S</b>	AA cell×4		
			

### Components

Holder material	Spring / Finish	Terminal / Finish
PP / PE	Steel / Nickel plating	Brass / Nickel plating

### Part no.

Part no.	Battery	Holder material	Weight(g)
SN 1-2 S	D (UM1) × 2	PP	22.7
SN 1-4 S	D (UM1) × 4	PP	43.6
SN 2-2 S	C (UM2) × 2	PP	16.5
SN 2-4 S	C (UM2) × 4	PP	26.0
SN 3-2 S	AA (UM3) × 2	PE	7.2
SN 3-3 S	AA (UM3) × 3	PP	9.6
SN 3-4 S	AA (UM3) × 4	PP	11.8

# SN·MP·BH211 SERIES

## SN · BH · MP BATTERY HOLDER WITH LEAD WIRE

SN 1-1

D cell×1

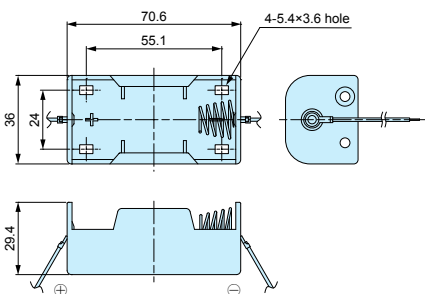

SN 1-2

D cell×2

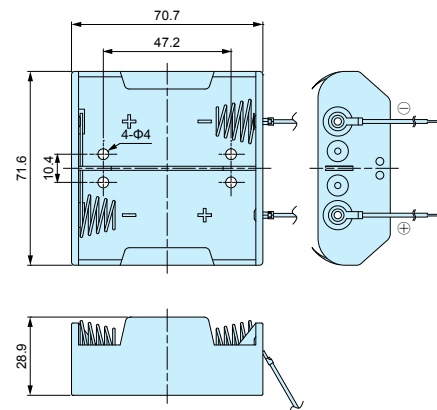
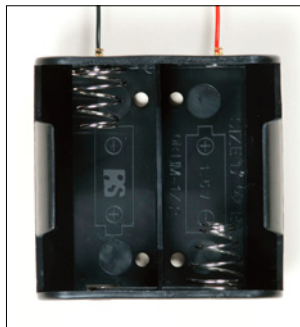

SN 1-4

D cell×4

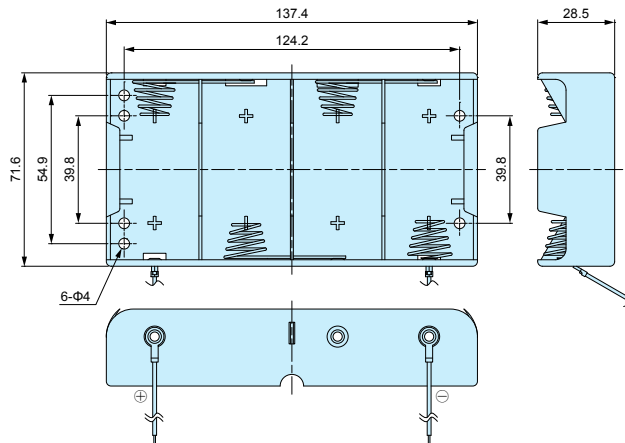
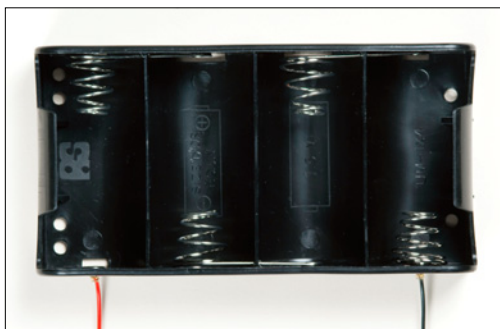

SN 1-6

D cell×6

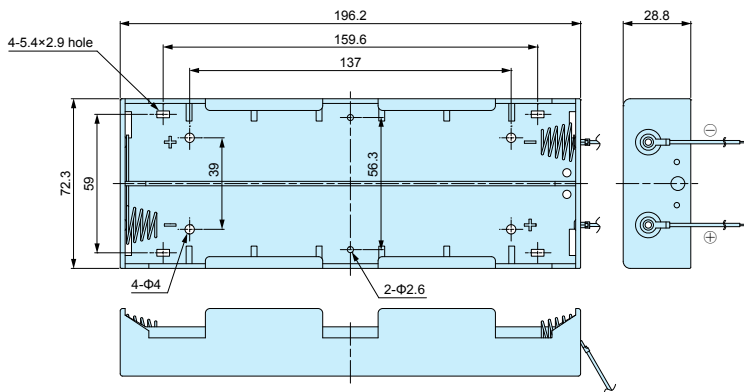
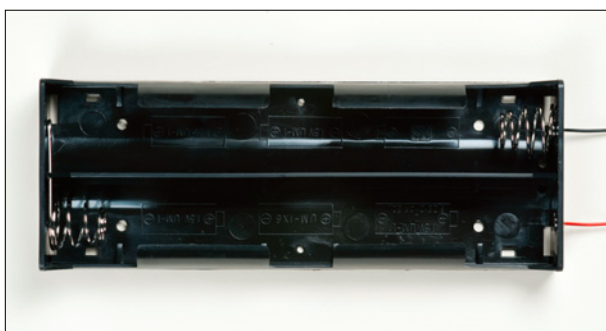

BH211-1

C cell×1

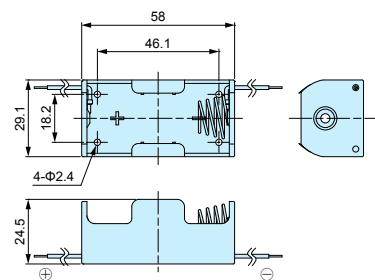

SN 2-2

C cell×2

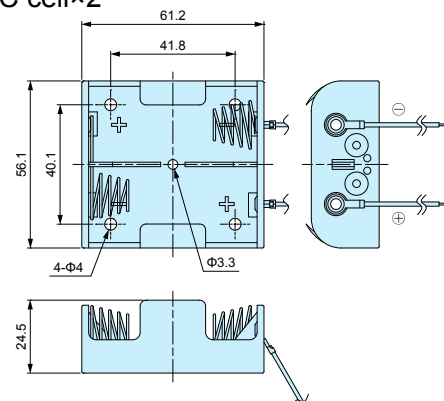
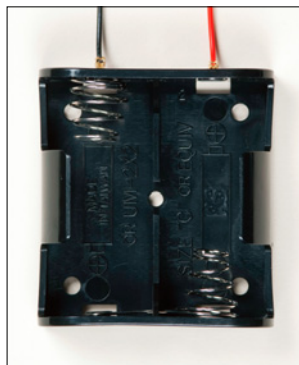

SN 2-4

C cell×4

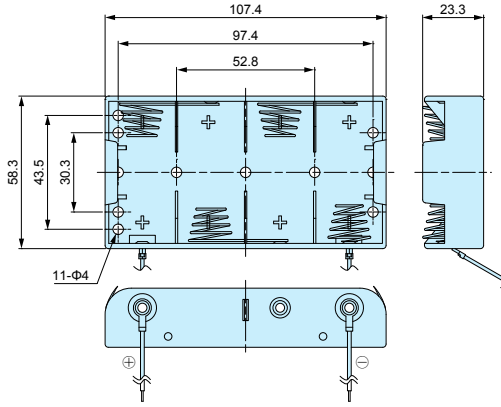
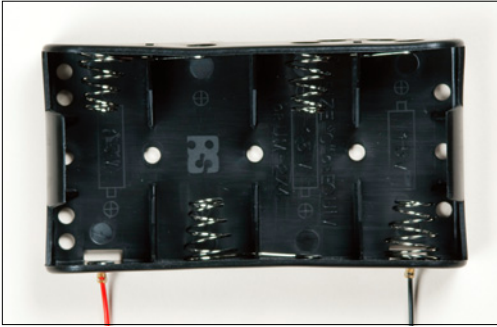

SN 3-1

AA cell×1

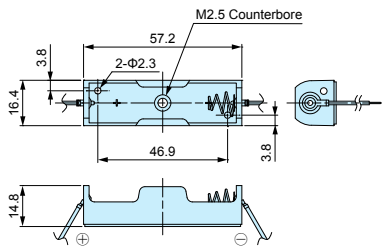

SN 3-2

AA cell×2

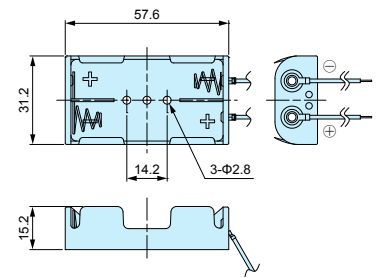
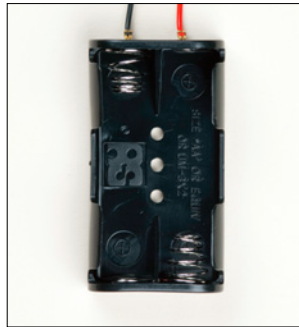

SN 3-2A

AA cell×2

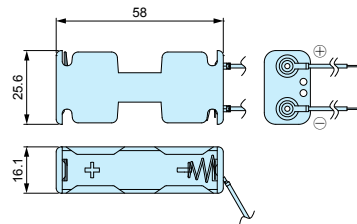
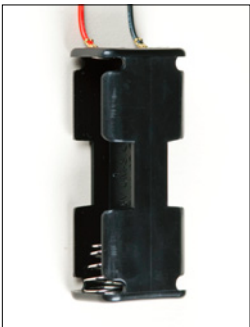

SN 3-3

AA cell×3

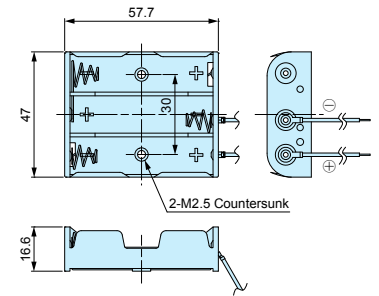
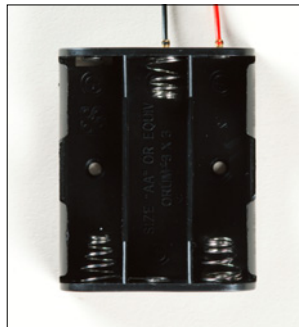

SN 3-4

AA cell×4

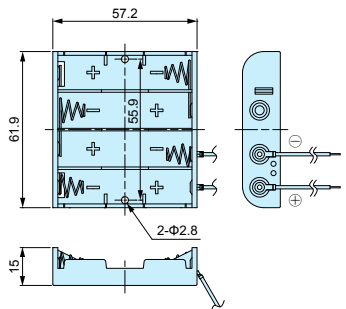
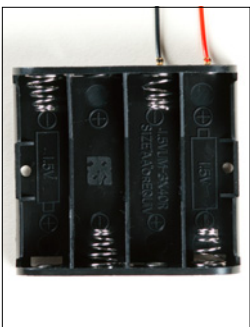

SN 3-4A

AA cell×4

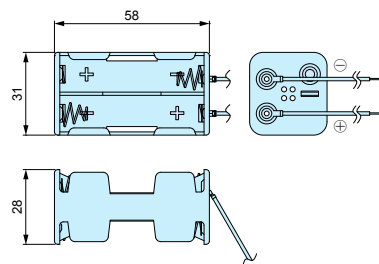

MP-3-6

AA cell×6

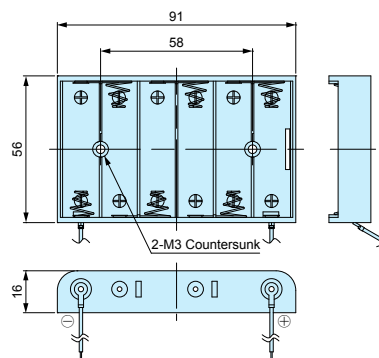
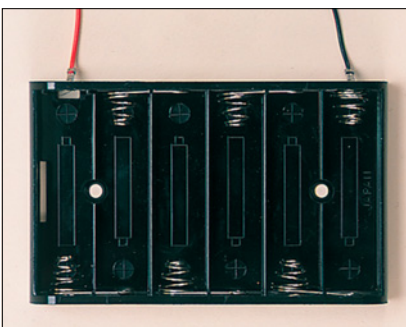



SN 3-6A

AA cell×6

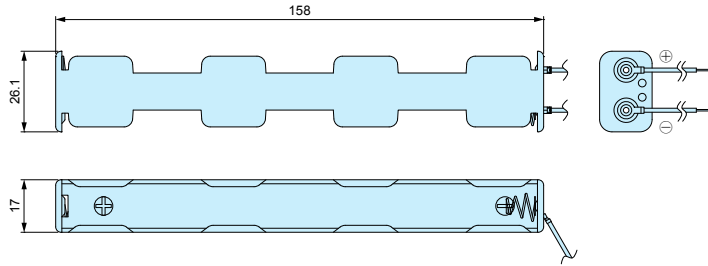

SN 3-6B

AA cell×6

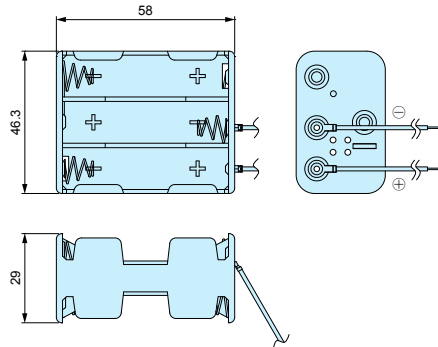
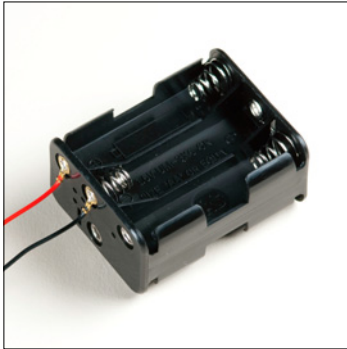

SN 3-8A

AA cell×8

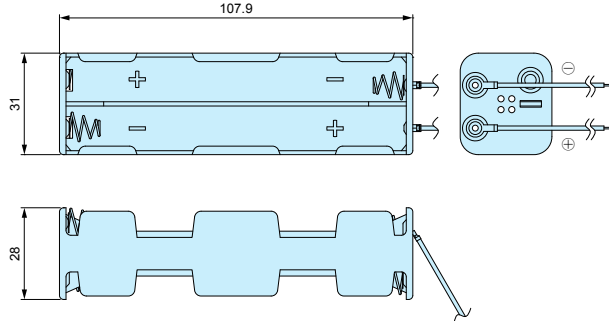
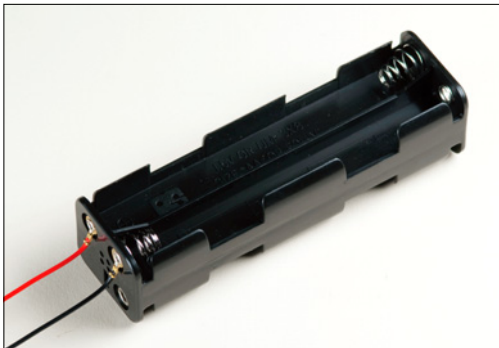

MP-4-1

AAA cell×1

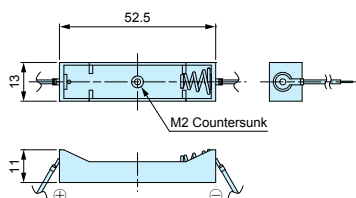

SN 4-2

AAA cell×2

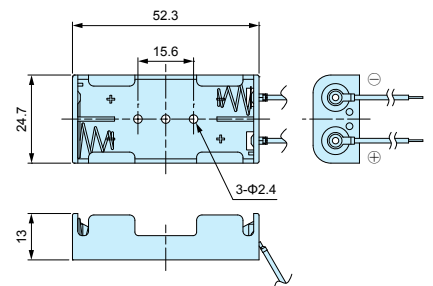
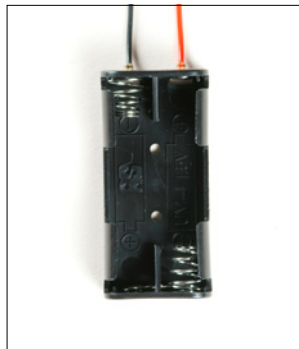

MP-4-3

AAA cell×3

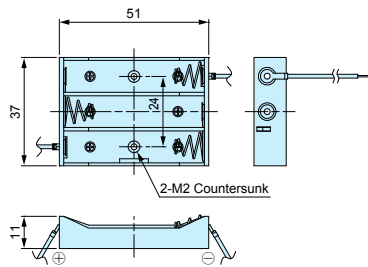

MP-4-4

AAA cell×4

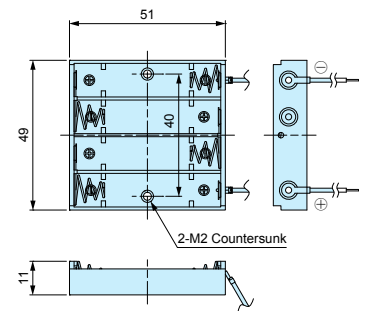
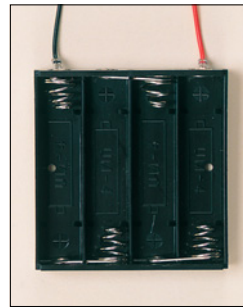

MP-5-1N

N cell×1

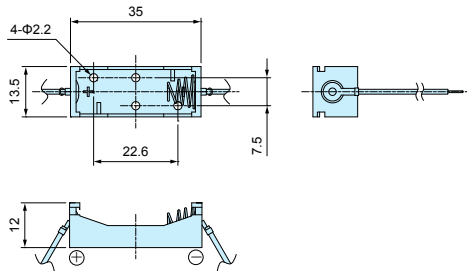
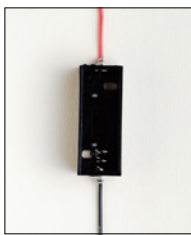

MP-5-2

N cell×2

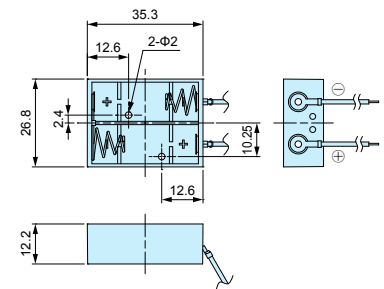

Components

Holder material	Spring / Finish	Terminal / Finish	Wire
PP / PE / ABS	Steel / Nickel plating	Brass / Nickel plating	AWG24 / AWG26 (UL1007)

Part no.

Part no.	Battery	Holder material	Wire	Weight(g)
SN 1-1	D (UM1) × 1	PP	AWG26 L=170	14.0
SN 1-2	D (UM1) × 2	PP	AWG26 L=170	22.8
SN 1-4	D (UM1) × 4	PP	AWG26 L=170	43.0
SN 1-6	D (UM1) × 6	PP	AWG26 L=170	52.7
BH211-1	C (UM2) × 1	PP	AWG24 L=150	9.3
SN 2-2	C (UM2) × 2	PP	AWG26 L=170	16.5
SN 2-4	C (UM2) × 4	PP	AWG26 L=170	26.0
SN 3-1	AA (UM3) × 1	PP	AWG26 L=160	4.4
SN 3-2	AA (UM3) × 2	PE	AWG26 L=160	7.8
SN 3-2A	AA (UM3) × 2	PP	AWG26 L=160	6.2
SN 3-3	AA (UM3) × 3	PP	AWG26 L=160	10.2
SN 3-4	AA (UM3) × 4	PP	AWG26 L=160	12.1
SN 3-4A	AA (UM3) × 4	PP	AWG26 L=160	9.8
MP-3-6	AA (UM3) × 6	ABS	AWG26 L=150	21.4
SN 3-6A	AA (UM3) × 6	PP	AWG26 L=160	12.9
SN 3-6B	AA (UM3) × 6	PP	AWG26 L=160	15.3
SN 3-8A	AA (UM3) × 8	PP	AWG26 L=160	14.8
MP-4-1	AAA (UM4) × 1	ABS	AWG26 L=150	3.3
SN 4-2	AAA (UM4) × 2	PP	AWG26 L=160	5.1
MP-4-3	AAA (UM4) × 3	ABS	AWG26 L=150	6.9
MP-4-4	AAA (UM4) × 4	ABS	AWG26 L=150	8.0
MP-5-1N	N (UM5) × 1	ABS	AWG26 L=150	2.6
MP-5-2	N (UM5) × 2	ABS	AWG26 L=150	4.7