

SIEMENS

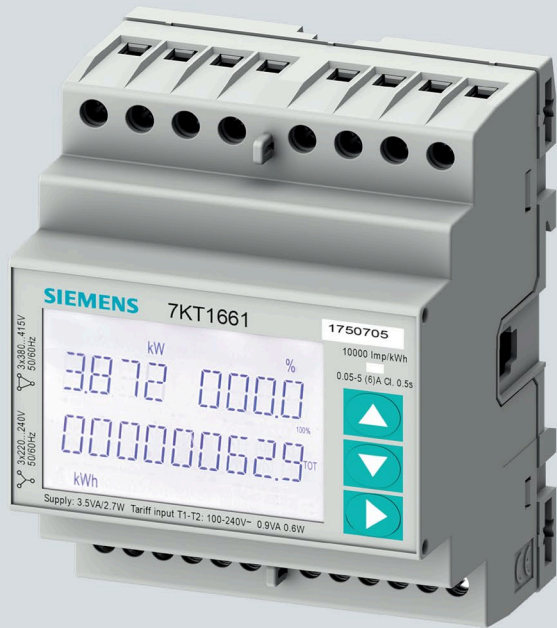

Manual

SENTRON

Measuring Devices

Energy Meter 7KT PAC1600

Edition

09/2020

[siemens.com/powermonitoring](https://www.siemens.com/powermonitoring)

SIEMENS

SENTRON

Measuring devices 7KT16 energy meter



Equipment Manual

<u>Introduction</u>	1
<u>Safety instructions</u>	2
<u>Description</u>	3
<u>Installation/removal</u>	4
<u>Connection</u>	5
<u>Commissioning</u>	6
<u>Service and maintenance</u>	7
<u>Technical data</u>	8
<u>Dimensional drawings</u>	9
<u>ESD guidelines</u>	A

Legal information

Warning notice system

This manual contains notices you have to observe in order to ensure your personal safety, as well as to prevent damage to property. The notices referring to your personal safety are highlighted in the manual by a safety alert symbol, notices referring only to property damage have no safety alert symbol. These notices shown below are graded according to the degree of danger.

 DANGER
indicates that death or severe personal injury will result if proper precautions are not taken.
 WARNING
indicates that death or severe personal injury may result if proper precautions are not taken.
 CAUTION
indicates that minor personal injury can result if proper precautions are not taken.
NOTICE
indicates that property damage can result if proper precautions are not taken.

If more than one degree of danger is present, the warning notice representing the highest degree of danger will be used. A notice warning of injury to persons with a safety alert symbol may also include a warning relating to property damage.

Qualified Personnel

The product/system described in this documentation may be operated only by **personnel qualified** for the specific task in accordance with the relevant documentation, in particular its warning notices and safety instructions. Qualified personnel are those who, based on their training and experience, are capable of identifying risks and avoiding potential hazards when working with these products/systems.

Proper use of Siemens products

Note the following:

 WARNING
Siemens products may only be used for the applications described in the catalog and in the relevant technical documentation. If products and components from other manufacturers are used, these must be recommended or approved by Siemens. Proper transport, storage, installation, assembly, commissioning, operation and maintenance are required to ensure that the products operate safely and without any problems. The permissible ambient conditions must be complied with. The information in the relevant documentation must be observed.

Trademarks

All names identified by ® are registered trademarks of Siemens AG. The remaining trademarks in this publication may be trademarks whose use by third parties for their own purposes could violate the rights of the owner.

Disclaimer of Liability

We have reviewed the contents of this publication to ensure consistency with the hardware and software described. Since variance cannot be precluded entirely, we cannot guarantee full consistency. However, the information in this publication is reviewed regularly and any necessary corrections are included in subsequent editions.

Table of contents

1	Introduction	7
1.1	Components of the product	7
1.2	Latest information	7
1.3	Advanced training courses	7
1.4	Open Source Software	8
1.5	Qualified personnel	9
2	Safety instructions	11
3	Description	15
3.1	Performance features.....	15
3.2	Measuring inputs.....	17
3.2.1	Current measurement.....	17
3.2.2	Voltage measurement.....	18
3.3	Single-phase devices.....	18
3.3.1	Keypad functions	19
3.3.2	Advanced functions	20
3.3.3	Selection of measured values.....	21
3.3.4	Parameterization	21
3.3.4.1	Devices with RS 485 interface	22
3.3.4.2	Devices with M-Bus interface	22
3.3.4.3	Devices with S0 interface or digital output	23
3.3.4.4	Setup parameter table	24
3.4	Three-phase devices 80 A	28
3.4.1	Keypad functions	29
3.4.2	Advanced functions	30
3.4.3	Selection of measured values.....	31
3.4.4	Parameterization	33
3.4.4.1	Devices with RS 485 interface	33
3.4.4.2	Devices with M-Bus interface	33
3.4.4.3	Setup parameter table for devices with RS 485 and M-Bus interface.....	33
3.4.4.4	Devices with S0 interface or digital output	37
3.4.4.5	Setup parameter table for devices with S0 interface	38
3.4.4.6	Programmable AC input.....	40
3.4.4.7	Settable values for parameters P2.01, P3.01, P4.01	40
3.5	Three-phase devices 5 A	42
3.5.1	Keypad functions	43
3.5.2	Advanced functions	45
3.5.3	Selection of measured values.....	46
3.5.4	Parameterization	48
3.5.4.1	Set parameters (setup).....	48
3.5.4.2	Energy measurement.....	50

3.5.4.3	Tariffs.....	51
3.5.4.4	Hour counter	52
3.5.4.5	Limit threshold status display (LIMx)	52
3.5.4.6	Alarm display.....	53
3.5.4.7	Parameter table	54
3.5.4.8	Command menu.....	64
3.5.5	Wiring test.....	65
3.6	Supporting software	66
3.6.1	powermanager	66
3.6.2	powerconfig.....	67
4	Installation/removal	69
4.1	Installation location	69
4.2	Installing/removing single-phase device	70
4.3	Installing three-phase device.....	70
4.4	Installing/removing three-phase device	70
5	Connection	71
5.1	Connection example for Modbus RTU.....	73
5.2	Connecting single-phase device	74
5.3	Connecting three-phase device	75
5.4	Wiring test.....	77
6	Commissioning	79
6.1	Overview.....	79
6.2	Applying the measuring voltage.....	80
6.3	Parameterizing with powerconfig.....	80
6.4	Modbus address register	82
6.4.1	Modbus address table for single-phase devices with Modbus interface	82
6.4.2	Modbus address table for three-phase devices 5 A with Modbus interface	84
6.4.3	Modbus address table for three-phase devices 80 A with Modbus interface	91
7	Service and maintenance	97
7.1	Firmware update	97
7.2	Lost or forgotten password	97
7.3	Fault elimination measures	97
7.4	Warranty	98
7.5	Disposal.....	98
8	Technical data	99
8.1	Technical data	99
8.2	Labels on the enclosure	103

9 Dimensional drawings..... 105

 9.1 Single-phase device 105

 9.2 Three-phase device..... 105

A ESD guidelines..... 107

 A.1 Electrostatic sensitive devices (ESD) 107

Index..... 109

Introduction

1.1 Components of the product

The package includes:

- Operating instructions
- 7KT PAC1600 energy counter

Available accessories

- powerconfig (<https://support.industry.siemens.com/cs/ww/en/view/63452759>)software
- powermanager (<https://support.industry.siemens.com/cs/ww/en/view/109746290>)software

1.2 Latest information

Up-to-the-minute information

You can find further support on the Internet (<http://www.siemens.com/lowvoltage/technical-assistance>) at:

1.3 Advanced training courses

Find out about training courses on offer on the following link.

Training for Industry (<https://www.siemens.com/sitrain-lowvoltage>)

Here you can choose from:

- Web-based training courses (online, informative, free)
- Classroom training courses (course attendance, comprehensive, subject to fee)

You also have the possibility of compiling your own training portfolio via **Learning paths**.

1.4 Open Source Software

STM32L1xx_StdPeriph_Driver V1.2.0:

Redistribution and use in source and binary forms, with or without modification, are permitted, provided that the following conditions are met:

1. Redistribution of source code must retain the above copyright notice, this list of conditions and the following disclaimer.
2. Redistributions in binary form must reproduce the above copyright notice, this list of conditions and the following disclaimer in the documentation and/or other materials provided with the distribution.
3. Neither the name of STMicroelectronics nor the names of other contributors to this software may be used to endorse or promote products derived from this software without specific written permission.
4. This software, including modifications and/or derivative works of this software, must execute solely and exclusively on microcontroller or microprocessor devices manufactured by or for STMicroelectronics.
5. Redistribution and use of this software other than as permitted under this license is void and will automatically terminate your rights under this license.

THIS SOFTWARE IS PROVIDED BY STMICROELECTRONICS AND CONTRIBUTORS "AS IS" AND ANY EXPRESS, IMPLIED OR STATUTORY WARRANTIES, INCLUDING, BUT NOT LIMITED TO, THE IMPLIED WARRANTIES OF MERCHANTABILITY, FITNESS FOR A PARTICULAR PURPOSE AND NON-INFRINGEMENT OF THIRD PARTY INTELLECTUAL PROPERTY RIGHTS ARE DISCLAIMED TO THE FULLEST EXTENT PERMITTED BY LAW. IN NO EVENT SHALL STMICROELECTRONICS OR CONTRIBUTORS BE LIABLE FOR ANY DIRECT, INDIRECT, INCIDENTAL, SPECIAL, EXEMPLARY, OR CONSEQUENTIAL DAMAGES (INCLUDING, BUT NOT LIMITED TO, PROCUREMENT OF SUBSTITUTE GOODS OR SERVICES; LOSS OF USE, DATA, OR PROFITS; OR BUSINESS INTERRUPTION) HOWEVER CAUSED AND ON ANY THEORY OF LIABILITY, WHETHER IN CONTRACT, STRICT LIABILITY, OR TORT (INCLUDING NEGLIGENCE OR OTHERWISE) ARISING IN ANY WAY OUT OF THE USE OF THIS SOFTWARE, EVEN IF ADVISED OF THE POSSIBILITY OF SUCH DAMAGE.

Copyright notices:

COPYRIGHT (c) 2015 STMicroelectronics International N.V. All rights reserved.

1.5 Qualified personnel

Some of the following tasks are carried out when hazardous voltage is present. For this reason, they must only be carried out by qualified personnel who are familiar with the safety regulations and precautions and who follow the safety regulations and precautions.

- Wear the prescribed protective clothing.
- Observe the general equipment regulations and safety regulations for working with high-voltage installations (e.g. DIN VDE, NFPA 70E), as well as national or international regulations.
- Ensure that the limits given in the technical data are not exceeded, not even during commissioning or testing.
- Short circuit the secondary connections of intermediate current transformers at the transformers before interrupting the current lines to the device.
- Test the polarity and the phase assignment of the instrument transformers.
- Before connecting the device, ensure that the system voltage matches the voltage specified on the type plate.
- Before commissioning, ensure that all connections have been made correctly.
- Before power is applied to the device for the first time, you must place it in the operating room for a period of at least two hours. This allows it to reach temperature balance and avoids humidity and condensation.

 **DANGER**

Risk of death due to electric shock and arc flashover!

For the 5 A device, it is only possible to measure the current via external current transformers. When using the current transformers, the circuit is not protected by a fuse.

- Switch off and lock out all power supplying this equipment before working on the device.
- Never open the secondary circuit of the current transformers under load.
- Short-circuit the secondary current terminals of the current transformer before removing this device.
- Always follow the safety instructions for the current transformers used.

 **DANGER**

Risk of death due to hazardous voltage!

Before starting work, disconnect the system and the device from the power supply.

 **WARNING**

Possible risk of death due to damaged device!

Using devices when they are damaged may result in death, serious injury, or property damage.

- Do not install damaged devices.
- Do not start up damaged devices.

NOTICE

Equipment damage due to lack of fusing

Non-fused voltage measuring inputs may lead to device and equipment damage.

Always protect the device with an IEC approved fuse or with an IEC approved miniature circuit breaker.

NOTICE

Device damage due to condensation

Humidity may cause condensation on the device if temperature balance has not been reached. Condensation may damage the device when it is connected to the power supply.

Do not connect the device to the power supply until temperature balance has been reached. To achieve temperature balance, place the device in the operating room for a period of at least two hours.



Note

RS 485 termination recommended

In order to avoid reflection on the bus cable, we recommend fitting a 120 Ω terminating resistor at the beginning and end of the bus cable.

To establish Modbus RTU communication, the communication parameters must be known. These include baud rate and format. Furthermore, you must have entered the slave address in the device.

Safety-related symbols on the device

Symbol	Meaning
	Risk of electric shock
	Electrical installation demands technical competence

Notes

Siemens provides products and solutions with industrial security functions that support the secure operation of plants, systems, machines and networks. In order to protect plants, systems, machines and networks against cyber threats, it is necessary to implement – and continuously maintain – a holistic, state-of-the-art industrial security concept. Siemens’ products and solutions constitute one element of such a concept.

Customers are responsible for preventing unauthorized access to their plants, systems, machines and networks. Such systems, machines and components should only be connected to an enterprise network or the Internet if and to the extent such a connection is necessary and only when appropriate security measures (e.g. firewalls and/or network segmentation) are in place.

For additional information on industrial security measures that may be implemented, please visit Internet (<http://www.siemens.com/industrialsecurity>).

Siemens' products and solutions undergo continuous development to make them more secure. Siemens strongly recommends that product updates are applied as soon as they are available and that the latest product versions are used. Use of product versions that are no longer supported, and failure to apply the latest updates may increase customer's exposure to cyber threats.

To stay informed about product updates, subscribe to the Siemens Industrial Security RSS Feed (<http://support.automation.siemens.com>).

Note

Risk of manipulation!

In order to reduce the risk of manipulation occurring on the device, it is recommended that the protective mechanisms available in the device are activated.

Default passwords for the protective mechanisms:

- Use 1000 for user rights without write access.
- Use 2000 for extended rights with write access.

Use a lead seal on the cover for security.

Description

3.1 Performance features

The PAC1600 is a measuring device for measuring the basic electrical variables in low-voltage power distribution. Measured variables are shown on the display of the PAC1600.

The PAC1600 is mounted on a DIN rail or is screwed in place using extractable clips.

Versions

The PAC1600 measuring device is available in several versions:

- **5 A devices:**

x / 5 A current transformers can be used for current measuring.

- **63 A and 80 A devices:**

No current transformers are required for current measuring. Connect the device directly to the low-voltage grid. The device can measure current of up to 63 A or 80 A directly.

Depending on the device version, the PAC1600 measuring device has an S0, RS 485 or M-Bus interface.

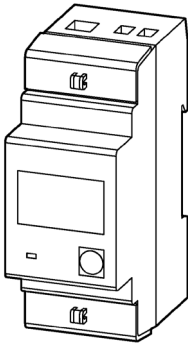
Single-phase devices	Description	
	7KT1651	63 A, Modbus RTU
	7KT1652	63 A, Modbus RTU, MID
	7KT1653	63 A, M-Bus
	7KT1654	63 A, M-Bus MID
	7KT1655	63 A, S0
	7KT1656	63 A, S0, MID

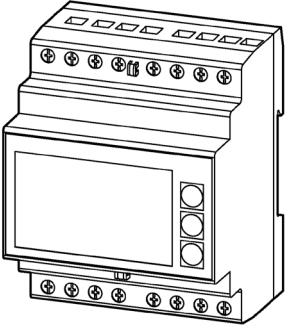
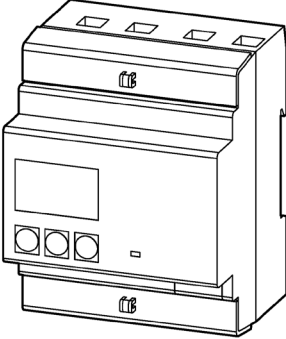
Three-phase devices	Description	
	7KT1661	5 A, Modbus RTU
	7KT1662	5 A, Modbus RTU, MID
	7KT1663	5 A, M-Bus
	7KT1664	5 A, M-Bus, MID
	7KT1672	5 A, S0
	7KT1673	5 A, S0, MID
	7KT1665	80 A, Modbus RTU
	7KT1666	80 A, Modbus RTU, MID
	7KT1667	80 A, M-Bus
	7KT1668	80 A, M-Bus, MID
	7KT1670	80 A, S0
	7KT1671	80 A, S0, MID

Measurement

Measurement of all relevant electrical variables in an AC system.

Interfaces

Optional interfaces depending on device version:

- S0
- RS 485
- M-Bus
- Digital input
- Digital output

Memory

Adjusted device parameters are permanently stored in the device memory.

MID-approved

MID-approved devices are included in the portfolio. These devices are suitable for billing purposes. Certain actions cannot be performed on devices with an MID mark, e.g. firmware update, reset of energy values.

3.2 Measuring inputs

3.2.1 Current measurement

NOTICE
Device damage due to DC current
The device is not suitable for measuring DC current. Only measure AC current with the device.

Design of the 5 A device

The 5 A device is designed for a rated current of 5 A for connecting standard current transformers.

Each current measuring input can take a continuous load of 6 A.

Design of 63 A and 80 A devices

The 63 A and 80 A devices are designed to be connected directly to the low-voltage grid.

3.2.2 Voltage measurement

NOTICE
Device damage due to DC voltage The device is not suitable for measuring DC voltage. Only measure AC voltage with the device.

Design of the PAC1600 device

PAC1600 is designed for

- Direct measurement on the grid
- Measuring input voltages up to 264 V phase-to-neutral
- Measuring input voltages up to 456 V phase-to-phase

3.3 Single-phase devices

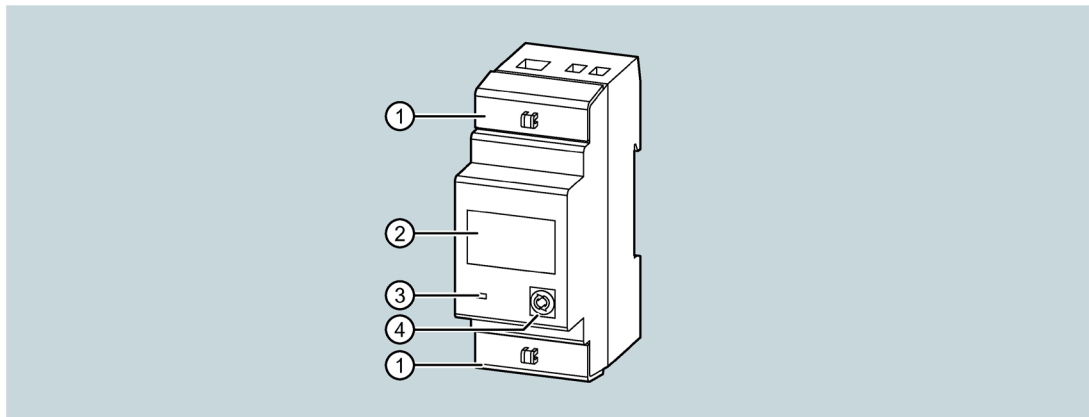

- ① Sealing cover
- ② Energy flow indicator
 - If the device detects an active energy flow to the load, a rotating "U" appears on the top right of the display.
 - If no active energy consumption is present, or if the load is drawing less than the starting current, the rotating "U" disappears.
- ③ Active energy pulse indicator
The red LED on the front panel outputs 1000 pulses for every kWh of energy consumed. The LED pulse frequency is proportional to the energy.
- ④ Front key
You will find information on operation in chapter Keypad functions (Page 19).

Basic properties

- DIN rail enclosure, 2 MW (36 mm wide)
- Direct connection for currents up to 63 A
- LCD with backlighting
- 6-digit counter with one place after the decimal point
- Key for selecting measured quantities and for setting parameters
- Active energy meter and reactive energy meter
- Partial meter for active and reactive energy
- Hour counter
- Pulse LED for active energy consumption
- Display of instantaneous consumption (active power)
- Optional: RS 485, M-Bus or S0 interface
- Optional: MID certification

3.3.1 Keypad functions

You can operate the device with the front key.

The front key is assigned different functions.

The function of the front key depends on the menu level currently in use.

Navigation with front key

1. To open the menu, press the front key (> 5 s).
2. Press the front key (> 3 s) while `SETUP` is visible on the display.
The first parameter code P-01 appears on the display.
3. Press the front key briefly to move to the next parameters (e.g. P-02, P-03).
4. When the code for the parameter you wish to change appears on the display, press the front key (> 3 s).
 - If this is a numeric parameter (password, threshold values, delays), the current value appears on the display. The individual digits flash in succession.
While a digit is flashing, you can increase that number by pressing the front key. The selection waits a few seconds for the next digit.
 - If the parameters make it possible to select between different functions (e.g. output functions, measurement), you can select the required function by repeatedly pressing the front key.

3.3 Single-phase devices

5. Press the front key (> 3 s) to confirm and return to the parameter code selection.
ESC appears on the display after the last parameter code.
6. Press the front key (> 3 s).
The parameters are saved. The system resumes normal operation.

3.3.2 Advanced functions

Procedure

1. Press the front key from any display (> 5 s).
 - If password protection is activated, PASS appears on the display. Proceed to point 2 (password entry).
 - If password protection is deactivated, (factory setting, default password = 0000), proceed to point 5 (function selection).
2. Release the key.
The device shows 0000 after approx. 2 to 3 seconds. The device is waiting for the password to be entered.
3. Enter the password. Press the front key to increase the flashing digit in each case.
After 3 seconds, the entry field jumps to the next position.
4. After entering the password, press the front key to confirm.
 - If the password is incorrect, PASS Er appears on the display and the normal display reappears.
 - If the password is correct, proceed to the next point.
5. The first entry in the following list of functions appears on the display:
 - CLEAR P: Clear partial energy meters
 - CLEAR h: Clear partial hour counter (if activated)
 - CLEAR d: Clear maximum demand values (if activated)
 - SETUP: Parameter programming (setup)
 - INFO: Revision and checksum of internal software
 - ESC: Return to normal displayPress the front key briefly to scroll through the list.
6. To select a function, press the front key for > 3 s while the function is visible on the display.

Note

If you keep the front key pressed for longer than 60 s, the menu closes automatically.

3.3.3 Selection of measured values

Press the front key briefly to select the displayed values on the screen in the sequence shown below.

Each measured variable is indicated by the corresponding symbol in the lower section of the display.

One minute after you last pressed the key, the display automatically switches to the screen for total active energy.

Symbol	Measured variable	Format
kWh	Total active energy	000000.0
kWh + part	Partial active energy	000000.0
kvarh	Total reactive energy	000000.0
kvarh + part	Partial reactive energy	000000.0
V	Voltage	000.0
A	Current	00.00
kW	Active power	00.00
kvar	Reactive power	00.00
PF	Power factor	0.00
Hz	Frequency	00.0
h ¹⁾	Hour counter (hhhh.mm)	00000.00
h + Part ¹⁾	Partial hour counter (hhhh.mm)	00000.00
kW + d ²⁾	15 min power demand values	00.00
kW + d + ▲ ²⁾	Max. power demand values	00.00

¹⁾ The measurements are only displayed if parameter P-08 is activated

²⁾ The measurements are only displayed if parameter P-09 is activated

3.3.4 Parameterization

Note

Follow the menu operation when setting the parameters. You can find more information on this in chapter Keypad functions (Page 19).

3.3.4.1 Devices with RS 485 interface

You can transmit the measured values of the energy meters via the RS 485 interface.

The device functions as a standard Modbus slave.

Serial communication is configured using setup parameters P-20 to P-24.

You can find the Modbus register tables in chapter Modbus address table for single-phase devices with Modbus interface (Page 82).

Parameters P-02 to P-07 can be used to define the behavior of a programmable limit threshold. Its status is transmitted.

The programmable limit threshold can be used, for example, to signal an alarm situation to a remote device.

Activation of the programmable limit threshold is indicated on the display by the  symbol.

Note

The status of the programmable limit threshold is not updated during parameterization (setup).

3.3.4.2 Devices with M-Bus interface

Devices with an M-Bus interface support 2 addressing paths:

- Primary address from 1 to 250
- Secondary address from 00000000 to 99999999

Baud rates from 300 to 38400 bps

Parameters P-02 to P-07 can be used to define the behavior of a programmable limit threshold. Its status is transmitted.

The programmable limit threshold can be used, for example, to signal an alarm situation to a remote device.

Activation of the programmable limit threshold is indicated on the display by the  symbol.

Note

The status of the programmable limit threshold is not updated during parameterization (setup).

3.3.4.3 Devices with S0 interface or digital output

You can use the digital output either as an S0 pulse output or as a limit threshold violation.

You can connect the device in PNP or NPN mode. You will find more information on this in chapters Technical data (Page 99), Dimensional drawings (Page 105), and Connecting single-phase device (Page 74).

Activation of the digital output is indicated on the display by the  symbol.

You can evaluate the S0 interface digital output using the following external devices, for example:

- Electromechanical meter
- PLC

If you choose the limit threshold violation setting, you can use the output for:

- Isolating low-priority loads
- Alarm signaling

Note

The status of the static output is not updated during parameterization (setup).

3.3.4.4 Setup parameter table

For all single-phase devices

Code	Description	Default	Range
P-01	Password	0000	0000 ... 9999
P-02	Activate programmable limit threshold	OFF	<ul style="list-style-type: none"> • OFF • THR
P-03	Limit threshold	kW	<ul style="list-style-type: none"> • 01 = kW • 02 = kvar • 03 = V • 04 = A • 05 = Hz • 06 = kWh part • 07 = h part • 08 = kW demand
P-04	Threshold ON	100.00	0.00 ... 999.99
P-05	Delay ON	5 s	0 ... 9999 s
P-06	Threshold OFF	50.00	0.00 ... 999.99
P-07	Delay OFF	5 s	0 ... 9999 s
P-08	Activate hour counter	OFF	<ul style="list-style-type: none"> • OFF • ON • THR
P-09	Activate demand values	OFF	<ul style="list-style-type: none"> • OFF • ON

Explanations about the code

P-01	Setting 0000 (default) deactivates password protection.
P-02	<p>Defines the function of the outputs depending on the device version.</p> <p>100 PUL ... 1 PUL</p> <p>Digital outputs function as pulse transmitters for active energy counting. These selection options define the number of pulses transmitted for each kWh.</p> <p>THR</p> <p>The digital output becomes an alarm threshold for the maximum or minimum limit, depending on the values programmed in P-04 and P-06.</p> <ul style="list-style-type: none"> • P-04 > P-06: <ul style="list-style-type: none"> – The output is activated if the value defined by P-03 is higher than P-04. – The output is deactivated if its value is lower than P-06 (maximum limit with hysteresis). • P-04 < P-06: <ul style="list-style-type: none"> – The output is activated if the value defined by P-03 is lower than P-04. – The output is activated if its value is higher than P-06 (minimum limit with hysteresis).
P-03	Selects the measured variable.
P-04,	Threshold value and delay for activation of the output.
P-05	The measurements are updated every 1 second.
P-06,	Threshold value and delay for deactivation of the output.
P-07	
P-08	<p>Defines the operating hours counter:</p> <ul style="list-style-type: none"> • OFF = Hour counter deactivated. The hour counter is not visible on the display. • ON = The hour counter is incremented for as long as the energy meter measures energy. • THR = The hour counter is incremented for as long as the threshold value defined by the parameter (P-02, P-03, P-04 and P-05) is active.
P-09	Enables the calculation and display of the active energy requirement and the maximum demand.

For single-phase devices with an RS 485 interface

Code	Description	Default	Range
P-20	Address	001	001 ... 255
P-21	Baud rate	9600	<ul style="list-style-type: none"> • 1200 • 2400 • 4800 • 9600 • 19200 • 38400
P-22	Data format	8 bit - n	<ul style="list-style-type: none"> • 8 bit, no parity • 8 bit odd, 8 bit even • 7 bit odd, 7 bit even
P-23	Stop bits	1	<ul style="list-style-type: none"> • 1 • 2
P-24	Protocol	Modbus RTU	<ul style="list-style-type: none"> • Modbus RTU • Modbus ASCII

Explanations about the code

- P-20 Address for serial communication
P-21 Baud rate (speed) for serial communication
P-22 Data format of serial communication
P-23 Stop bits of serial communication
P-24 Selects the Modbus protocol

For single-phase devices with an M-Bus interface

Code	Description	Default	Range
P-20	Primary address	001	001 ... 250
P-21	Secondary address HIGH	Serial number	0000 ... 9999
P-22	Secondary address LOW	Serial number	0000 ... 9999
P-23	Baud rate	2400	<ul style="list-style-type: none"> • 300 • 600 • 1200 • 2400 • 4800 • 9600 • 19200 • 38400

Explanations about the code

P-20 Main address

P-21, Secondary address, 1st half (4 digits), 2nd half (4 digits).

P-22 The complete secondary address can be obtained by concatenating the contents of parameter P8.02 with P8.03.

Example:

Secondary address 12345678, set P8.02 = 1234 and P8.03 = 5678.

3.4 Three-phase devices 80 A

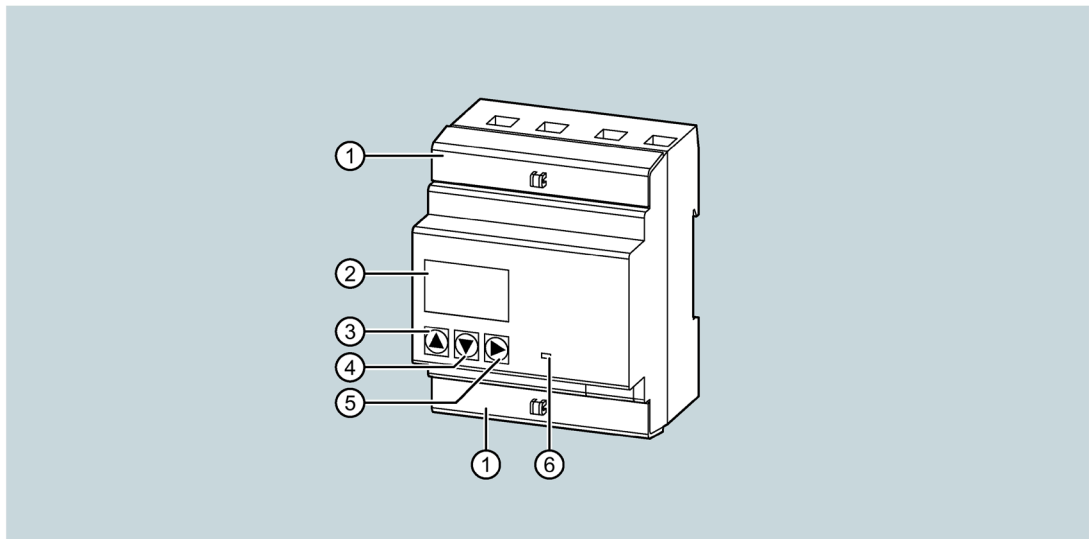

- ① Sealing cover
- ② Energy flow indicator
 - If the device detects an active energy flow, a rotating symbol appears on the top right of the display.
 - If no active energy consumption is present, or if the load is drawing less than the starting current, the rotating symbol disappears.
 - If energy measurement (export) is activated (P01.02 = ON) and if the device detects an active energy flow, a counter-clockwise rotating symbol appears on the top right of the display.
 - If measurement of the active energy (export) is deactivated (P01.02 = OFF) and if one or more phases has been connected incorrectly, error code `Err 3` appears on the display. Check the connections.
- ③ "Increase" key
- ④ "Decrease" key You will find information on operation in chapter Keypad functions (Page 29) ff.
- ⑤ "Next" key
- ⑥ Active energy pulse indicator

The red LED on the front panel outputs 1000 pulses for every kWh of energy consumed or output. If energy is imported from at least one of the phases, the LED indicates the energy as a balance between imported and exported energy. The LED pulse frequency is proportional to the energy.

Basic properties

- DIN rail enclosure, 4 MW (72 mm wide)
- Direct connection for currents up to 80 A
- LCD with backlighting
- 6-digit counter with one place after the decimal point
- 3 keys for selecting measured variables and for setting parameters
- Active and reactive energy meter
- Partial meter for active and reactive energy
- Three hour counters
- Pulse LED for active energy consumption
- Display of instantaneous consumption (active power)
- Optional: RS 485, M-Bus or S0 interface
- Optional: MID certification
- AC input for tariff selection

3.4.1 Keypad functions

You can operate the device with three keys.

The keys are assigned different functions.

The functions of the keys depend on the menu level currently in use.

"Increase" and "Decrease" keys

- Press the "Increase" or "Decrease" keys:
 - Scroll between screens
 - Select available options on the display
 - Change (increase/decrease) settings
- Press the "Increase" and "Decrease" keys simultaneously (> 5 s): Opens and closes the various display and setup menus.

"Next" key

- Scroll to subpages
- Confirm selected options
- Switch between display modes

Setting parameters

1. Press the "Next" key while `SETUP` is visible on the display.
The first parameter code `P1-01` appears on the display.
2. Use the "Increase" or "Decrease" key to move to the next parameters `P-02`, `P-03`, etc.
3. When the display shows the code of the parameter to be changed, press "Next".
4. When the code of the parameter that needs to be changed appears in the display, press "Next".
The display shows the current value of the parameter.
5. Change the value using the "Increase" or "Decrease" key.
6. To define the default value, press the "Increase" and "Decrease" keys simultaneously.
7. To return to parameter selection confirm with "Next".
8. Press the "Increase" and "Decrease" keys simultaneously (> 1 s).
The parameters are saved. The system resumes normal operation.

3.4.2 Advanced functions

Procedure

1. Press both keys "Increase" and "Decrease" simultaneously (> 5 s).
 - If password protection is activated, `PASS` **appears on the display**. Proceed to point 2 (password entry).
 - If password protection is deactivated, (factory setting, default password = 0000), proceed to point 6 (function selection).
2. Release the keys.
0000 appears on the screen. The device is waiting for the password to be entered.
3. Press "Increase" or "Decrease" to change the flashing digit.
4. Press "Next" to select the next digit.
5. After entering the password, press the "Next" key to confirm.
 - If the password is incorrect, `PASS Er` appears on the screen and the normal display reappears.
 - If the password is correct, proceed to the next point.

6. The first entry in the following list appears on the display:

- CLEAR P: Clear partial energy meters
- CLEAR h: Clear partial hour counter (if activated)
- CLEAR d: Clear maximum demand values (if activated)
- ET-DEF: Set all parameters to the default values.
- SETUP: Parameter programming (setup)
- INFO: Revision and checksum of internal software
- ESC: Return to normal mode

Press the "Increase" or "Decrease" key to scroll through the list.

7. Press the "Next" key to select a function.

Note

If you keep the keys pressed for longer than 60 s, the menu closes automatically.

3.4.3 Selection of measured values

Press either the "Increase" or "Decrease" key to select the measured values on the display in the sequence shown in the table below. Each measured variable is indicated by the corresponding symbol in the lower section of the display.

Press the "Next" key to select the display of total or single phase measurement.

The device normally displays the total values (system) indicated in the table below by the symbol Σ . In this case, only the value and the unit of measurement appear on the screen.

If, on the other hand, the selected measurement refers to a particular phase, the symbol for this phase (L1, L2, L3) appears in the upper section of the display.

One minute after the last key press, the display automatically switches to the screen for the active energy total.

Note

The measurements in **bold type** are only displayed if you have activated the associated activation parameter.

Description

3.4 Three-phase devices 80 A

Symbol	Measured variable pages	Format	Subpages			
	Select with "Increase" or "Decrease"		Select with "Next"			
kWh	Total active energy import	000000.0	Σ	L1	L2	L3
kWh + part	Partial active energy import	000000.0	Σ	L1	L2	L3
kWh T1 ¹⁾	Active energy import tariff 1	000000.0	Σ	L1	L2	L3
kWh T2 ¹⁾	Active energy import tariff 2	000000.0	Σ	L1	L2	L3
kWh	Total active energy export	-000000.0	Σ	L1	L2	L3
kWh + part	Partial active energy export	-000000.0	Σ	L1	L2	L3
kWh T1 ¹⁾	Active energy export tariff 1	-000000.0	Σ	L1	L2	L3
kWh T2 ¹⁾	Active energy export tariff 2	-000000.0	Σ	L1	L2	L3
kvarh	Total reactive energy import	000000.0	Σ	L1	L2	L3
kvarh + part	Partial reactive energy import	000000.0	Σ	L1	L2	L3
kvarh T1 ¹⁾	Reactive energy import tariff 1	000000.0	Σ	L1	L2	L3
kvarh T2 ¹⁾	Reactive energy import tariff 2	000000.0	Σ	L1	L2	L3
kvarh	Total reactive energy export	-000000.0	Σ	L1	L2	L3
kvarh + part	Partial reactive energy export	-000000.0	Σ	L1	L2	L3
kvarh T1 ¹⁾	Reactive energy export tariff 1	-000000.0	Σ	L1	L2	L3
kvarh T2 ¹⁾	Reactive energy export tariff 2	-000000.0	Σ	L1	L2	L3
V	Voltage phase L/N or L/L	000.0	Σ	L1	L2	L3
			Σ	L1L2	L2L3	L3L1
A	Current	00.00	-	L1	L2	L3
kW	Active power	00.00	Σ	L1	L2	L3
kvar ²⁾	Reactive power	00.00	Σ	L1	L2	L3
PF	Power factor	0.00	Σ	L1	L2	L3
Hz	Frequency	00.0	-	-	-	-
h + part	Partial hour counter (hhhh.mm)	00000.00	-	L1	L2	L3
kW + d	15 min power demand values	00.00	-	-	-	-
kW + d + ▲	Max. power demand values	00.00	-	-	-	-

- 1) These measurements are only displayed if the programmable input function is set to tariff selection. The tariff currently selected by the external input is indicated by a flashing T1 or T2 symbol.
- 2) The character "I" appears on the display in the case of an inductive value. The character "C" appears in the case of a capacitive value.

3.4.4 Parameterization

3.4.4.1 Devices with RS 485 interface

You can transmit the measured values of the energy meters via the RS 485 interface.

The device functions as a standard Modbus slave.

The Modbus register table is provided in the appendix. You can find more information in chapter Modbus address table for three-phase devices 80 A with Modbus interface (Page 91).

3.4.4.2 Devices with M-Bus interface

Devices with an M-Bus interface support 2 addressing paths:

- Primary address from 1 to 250
- Secondary address from 00000000 to 99999999

Baud rates from 300 to 38400 bps.

3.4.4.3 Setup parameter table for devices with RS 485 and M-Bus interface

For all variants

Code	Description	Default	Range
P1-01	Password	0000	0000 ... 9999
P1-02	Activate energy displays (export)	OFF	<ul style="list-style-type: none"> • OFF • ON
P2-01	Measured variable for hour counter 1 limit	01 kW	See Settable values for parameters P2.01, P3.01, P4.01 (Page 40).
P2-02	Limit 1 ON	10.00	-9999.99 ... 9999.99
P2-03	Limit 1 OFF	5.00	-9999.99 ... 9999.99
P3-01	Measured variable for hour counter 2 limit	01 kW	See Settable values for parameters P2.01, P3.01, P4.01 (Page 40).
P3-02	Limit 2 ON	10.00	-9999.99 ... 9999.99
P3-03	Limit 2 OFF	5.00	-9999.99 ... 9999.99
P4-01	Measured variable for hour counter 3 limit	01 kW	See Settable values for parameters P2.01, P3.01, P4.01 (Page 40).
P4-02	Limit 3 ON	10.00	-9999.99 ... 9999.99
P4-03	Limit 3 OFF	5.00	-9999.99 ... 9999.99
P5-01	Function of input 1	OFF	<ul style="list-style-type: none"> • OFF = Deactivated • ON = Activated • TAR = Tariff selection • CLr Part = Clear partial energy meter • CLr Hr = Clear hour counter • CLr dE = Clear max. demand values

Code	Description	Default	Range
P6-01	Activate hour counter 1	OFF	<ul style="list-style-type: none"> • OFF • ON • THR • INP
P6-02	Activate hour counter 2	OFF	<ul style="list-style-type: none"> • OFF • ON • THR • INP
P6-03	Activate hour counter 3	OFF	<ul style="list-style-type: none"> • OFF • ON • THR • INP
P7-01	Activate demand values	OFF	<ul style="list-style-type: none"> • OFF • ON
P7-02	Reactive power calculation method	FUND	<ul style="list-style-type: none"> • TOT • FUND

For the variant with RS 485 interface

Code	Description	Default	Range
P8-01	Address	001	001 ... 255
P8-02	Baud rate	9600	<ul style="list-style-type: none"> • 1200 • 2400 • 4800 • 9600 • 19200 • 38400
P8-03	Data format	8 bit = n	<ul style="list-style-type: none"> • 8 bit, no parity • 8 bit, odd • 8 bit, even • 7 bit, odd • 5 bit, even
P8-04	Stop bit	1	<ul style="list-style-type: none"> • 1 • 2
P8-05	Protocol	Modbus RTU	<ul style="list-style-type: none"> • Modbus RTU • Modbus ASCII

For the variant with M-Bus interface

Code	Description	Default	Range
P8-01	Primary address	001	001 ... 250
P8-02	Secondary address HIGH	Serial number	0000 ... 9999
P8-03	Secondary address LOW	Serial number	0000 ... 9999
P8-04	Baud rate	2400	<ul style="list-style-type: none"> • 300 • 600 • 1200 • 2400 • 4800 • 9600 • 19200 • 38400

Explanations about the code

- P1-01 Setting 0000 (default) deactivates password protection. Every other setting defines the password for access to advanced functions.
- P1-02 Activate energy displays (export)
- P2-01 Select code for comparison with threshold values for hour counter 1. You can find more information in Settable values for parameters P2.01, P3.01, P4.01 (Page 40).
- P2-02 Threshold for activation of hour counter 1. Note: The measurements are updated every second.
- P2-03 Threshold for deactivation of hour counter 1. The measurements are updated every second.
- $P2-02 \geq P2-03$:
 - The hour counter is activated if the value defined by P2-01 is higher than P2-02.
 - The hour counter is deactivated if its value is lower than P2-03 (maximum limit with hysteresis).
 - $P2-02 < P2-03$:
 - The hour counter is activated if the value defined by P2-01 is lower than P2-02.
 - The hour counter is deactivated if its value is higher than P2-03 (minimum limit with hysteresis).
- P3-01, P3-02, P3-03 As with P2-01, P2-02 and P2-03, with reference to hour counter 2.
- P4-01, P4-02, P4-03 As with P2-01, P2-02 and P2-03, with reference to hour counter 3.

- P5-01 Selects the function of the programmable input:
- OFF = Input deactivated.
 - ON = Input activated (for general functions, such as hour counter enable).
 - TAR = Selects the energy tariff (T1 / T2).
 - CLr Part = Clears the partial energy meters
 - CLr Hr = Clears all hour counters.
 - CLr dE = Clears the max. demand values.
- P6-01 Defines the operation of hour counter 1:
- OFF = Hour counter deactivated. It is not visible on the display.
 - ON = The hour counter is incremented for as long as the energy meter measures energy.
 - THR = The hour counter is incremented for as long as the threshold value defined by parameter P2-01, P2-02 and P2-03 is active.
 - INP = The hour counter is incremented for as long as the programmable input is activated. Parameter P5.01 must be set to ON.
- P6-02 Defines the operation of hour counter 2:
- OFF = Hour counter deactivated. It is not visible on the display.
 - ON = The hour counter is incremented for as long as the energy meter measures energy.
 - THR = The hour counter is incremented for as long as the threshold value defined by parameter P3-01, P3-02 and P3-03 is active.
 - INP = The hour counter is incremented for as long as the programmable input is activated. Parameter P5.01 must be set to ON.
- P6-03 Defines the operation of hour counter 3:
- OFF = Hour counter deactivated. It is not visible on the display.
 - ON = The hour counter is incremented for as long as the energy meter measures energy.
 - THR = The hour counter is incremented for as long as the threshold value defined by parameter P4-01, P4-02 and P4-03 is active.
 - INP = The hour counter is incremented for as long as the programmable input is activated. Parameter P5.01 must be set to ON.
- If one of the hour counters is running, the corresponding decimal point flashes.
- P7-01 Activates the calculation and visualization of power demand values and max. demand values.
- P7-02 Selects the calculation method for reactive power.
- TOT: The reactive power contains all harmonics. In this case: $P_{\text{reactive}}^2 = P_{\text{apparent}}^2 - P_{\text{active}}^2$ and PF is displayed on the PF/cosφ page.
 - FUND: The reactive power only contains the fundamental component. In this case: $P_{\text{reactive}}^2 \leq P_{\text{apparent}}^2 - P_{\text{active}}^2$ and cosφ is displayed on the PF/cosφ page.

3.4.4.4 Devices with S0 interface or digital output

The devices have two mutually independent digital outputs.

You can use the digital output either as an S0 pulse output or as a limit threshold violation.

You can connect the device in PNP or NPN mode. You can find more information in chapters Technical data (Page 99), Dimensional drawings (Page 105) and Connecting three-phase device (Page 75).

Activation of the digital outputs is indicated on the display by the symbols  and .

If the output is programmed as an S0 interface, you can connect the energy meter to the following devices:

- Electromechanical meter
- PLC

If you choose the limit threshold violation setting, you can use the output for:

- Isolating unimportant loads
- Alarm signaling

Note

The status of the digital output is not updated during parameterization (setup).

3.4.4.5 Setup parameter table for devices with S0 interface

Device-dependent parameters

Code	Description	Default	Range
P1-01	Password	0000	0000 ... 9999
P2-01	Function of output 1	10 PUL/kWh	<ul style="list-style-type: none"> • OFF = Deactivated • 1000 PUL/kWh • 100 PUL/kWh • 10 PUL/kWh • 1 PUL/kWh • THR = Programmable limit thresholds
P2-02	Measured variable for output 1 limit	01 kW	See Settable values for parameters P2.01, P3.01, P4.01 (Page 40).
P2-03	Limit 1 ON	100.00	0.00 ... 999.99
P2-04	Delay 1 ON	5 s	0 ... 9999 s
P2-05	Limit 1 OFF	50.00	0.00 ... 999.99
P2-06	Delay 1 OFF	5 s	0 ... 9999 s
P3-01	Function of output 2	OFF	<ul style="list-style-type: none"> • OFF = Disabled • 1000 PUL/kWh • 100 PUL/kWh • 10 PUL/kWh • 1 PUL/kWh • THR = programmable thresholds
P3-02	Measured variable for output 2 limit	01 kW	See Settable values for parameters P2.01, P3.01, P4.01 (Page 40).
P3-03	Limit 2 ON	100.00	0.00 ... 999.99
P3-04	Delay 2 ON	5 s	0 ... 9999 s
P3-05	Limit 2 OFF	50.00	0.00 ... 999.99
P3-06	Delay 2 OFF	5 s	0 ... 9999 s
P4-01	Function of input 1	OFF	<ul style="list-style-type: none"> • OFF = Deactivated • ON = Activated • TAR = Tariff selection • CLr Part = Clear partial energy meter • CLr Hr = Clear hour counter • CLr dE = Clear max. demand values

Code	Description	Default	Range
P5-01	Activate hour counter	OFF	<ul style="list-style-type: none"> • OFF • ON • THR1 • THR2 • INP
P5-02	Activate demand values	OFF	<ul style="list-style-type: none"> • OFF • ON

P1-01 Setting 0000 (default) deactivates password protection. Every other setting defines the password for access to advanced functions.

P2-01 Defines the function of output 1:

- OFF = Deactivated
- 1000 PUL ... 1 PUL = Output 1 functions as a pulse transmitter for active energy counting. This selection defines the number of pulses transmitted for each kWh.
- THR = Output 1 becomes an alarm threshold for the maximum or minimum limit, depending on the values programmed in P2-03 and P2-05.

If $P2-03 \geq P2-05$, the output is activated if the measurement defined by P2-02 is higher than P2-03 and deactivated if its value is lower than P2-05 (maximum limit with hysteresis).

If $P2-03 < P2-05$, the output is activated if the measurement defined by P2-02 is lower than P2-03 and activated if its value is lower than P2-05 (minimum limit with hysteresis).

P2-02 Selects the measured variable for comparison with limit thresholds. You can find more information on this in chapter Settable values for parameters P2.01, P3.01, P4.01 (Page 40).

P2-03, Limit threshold and delay for activation of the output.

P2-04 Note: The measurements are updated every second. The inaccuracy of this delay lies within the range from 0 to 1 second.

P2-05, Limit threshold and delay for deactivation of the output.

P2-06

P3-01 ... Same function as P2-01 ... P2-06, but with reference to output 2.

P3-06

P4-01 Selects the function of the programmable input:

- OFF = Input deactivated.
- ON = Input activated (for general functions, such as hour counter enable).
- TAR = Selects the energy tariff (T1/T2).
- CLr Part = Clears the partial energy meters
- CLr Hr = Clears the hour counter.
- CLr dE = Clears the max. demand values.

3.4 Three-phase devices 80 A

- P5-01 Defines the operating hours counter:
- OFF = Hour counter deactivated. Nothing appears on the display.
 - ON = The hour counter is incremented for as long as the energy meter measures energy.
 - THR1 = The hour counter is incremented for as long as the limit threshold defined by the parameters (P2-01 ... P2-06) is active.
 - THR2 = The hour counter is incremented for as long as the limit threshold defined by the parameters (P3-01 ... P3-06) is active.
 - INP = The hour counter is incremented for as long as the programmable input is activated. Parameter P4.01 must be set to ON.
- P5-02 Activates the calculation and display of power demand values and max. demand values.

3.4.4.6 Programmable AC input

Three-phase devices have a programmable AC input.

This input is deactivated by default. Set parameter P5.01 to select the required function.

You can use the input as follows:

- For 2 different tariffs (T1 and T2) with independent energy meters
- For resetting partial counters, hour counters and demand values
- For activating hour counters

3.4.4.7 Settable values for parameters P2.01, P3.01, P4.01

Setup	Unit of measurement	Measured value
01	kW	Active power ¹⁾
02	kW	Total active power
03	kW L1	Active power L1
04	kW L2	Active power L2
05	kW L3	Active power L3
06	kvar	Reactive power ¹⁾
07	kvar	Reactive power
08	kvar L1	Reactive power L1
09	kvar L2	Reactive power L2
10	kvar L3	Reactive power L3
11	kVA	Apparent power ¹⁾
12	kVA	Total apparent power
13	kvar L1	Apparent power L1
14	kvar L2	Apparent power L2
15	kvar L3	Apparent power L3
16	V L-n	Phase voltage ¹⁾
17	V L1	Phase voltage L1N

Setup	Unit of measurement	Measured value
18	V L2	Phase voltage L2N
19	V L3	Phase voltage L3N
20	V L-L	Phase-to-phase voltage ¹⁾
21	V L1L2	Phase-to-phase voltage L1L2
22	V L2L3	Phase-to-phase voltage L2L3
23	V L3L1	Phase-to-phase voltage L-L1
24	A	Voltage ¹⁾
25	A L1	Voltage L1
26	A L2	Voltage L2
27	A L3	Voltage L3
28	PF	Power factor ¹⁾
29	PF	Power factor (total)
30	PF L1	Power factor L1
31	PF L2	Power factor L2
32	PF L3	Power factor L3
33	HZ	Frequency
34	kWh+ part	Partial active energy
35	kWh+ L1 part	Partial active energy L1 (import)
36	kWh+ L2 part	Partial active energy L2 (import)
37	kWh+ L3 part	Partial active energy L3 (import)
38	kWh- part	Partial active energy (export)
39	kWh- L1 part	Partial active energy L1 (export)
40	kWh- L2 part	Partial active energy L2 (export)
41	kWh- L3 part	Partial active energy L3 (export)
42	kWh+ part	Partial reactive energy (import)
43	kWh+ L1 part	Partial reactive energy L1 (import)
44	kWh+ L2 part	Partial reactive energy L2 (import)
45	kWh+ L3 part	Partial reactive energy L3 (import)
46	kWh- part	Partial reactive energy (export)
47	kWh- L1 part	Partial reactive energy L1 (export)
48	kWh- L2 part	Partial reactive energy L2 (export)
49	kWh- L3 part	Partial reactive energy L3 (export)
50	kW d	Active power demand values

¹⁾ If limit thresholds are used for these measurements, the comparison is performed based on the highest or the lowest of the three phases, depending on the type of limit (maximum or minimum).

Example:

If a maximum limit threshold is defined for the phase voltages, the limit is activated if one of the three voltages is above the limit threshold.

3.5 Three-phase devices 5 A

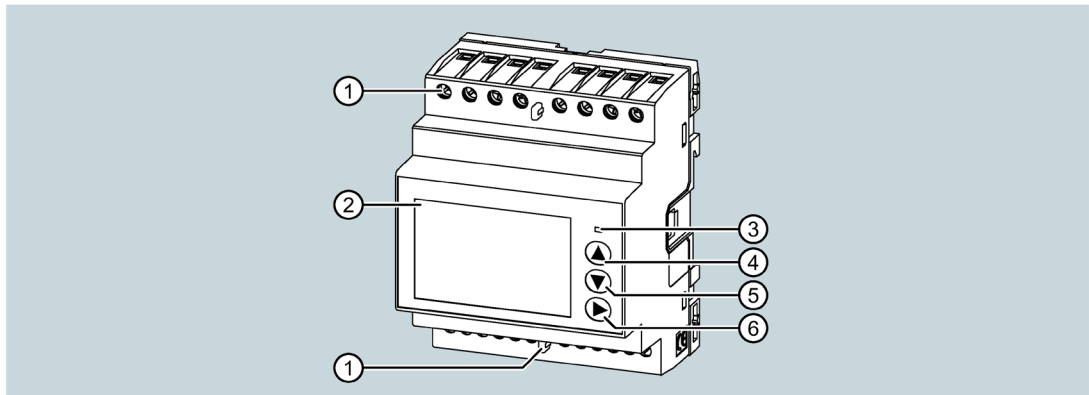

- ① Sealing cover
- ② Display
- ③ Active energy pulse indicator
The red LED on the front panel outputs 10000 pulses for every kWh of energy consumed or output, with reference to the secondary current transformer.
The flashing frequency of the LED immediately indicates how much current is required in any particular moment.
The duration of flashing, the color and the intensity of the LED correspond to the standards which specify their use for testing the accuracy of measurement of the energy meter.
- ④ "Increase" key
- ⑤ "Decrease" key You will find information on operation in chapter Keypad functions (Page 43) ff.
- ⑥ "Next" key

Basic properties

- DIN rail enclosure, 4 MW (72 mm wide)
- Current transformer connection x / 5 A
- LCD with backlighting
- 3 keys for selecting measured variables and for setting parameters
- Active and reactive energy meter
- Partial meter for active and reactive energy
- Several hour counters
- Two-level password protection
- Pulse LED for active energy consumption
- Display of instantaneous consumption (active power)
- Optional: RS 485, M-Bus or S0 interface
- Optional: MID certification

- AC input for tariff selection
- Texts available in six languages
 - English
 - Italian
 - French
 - Spanish
 - Portuguese
 - German

Display indications

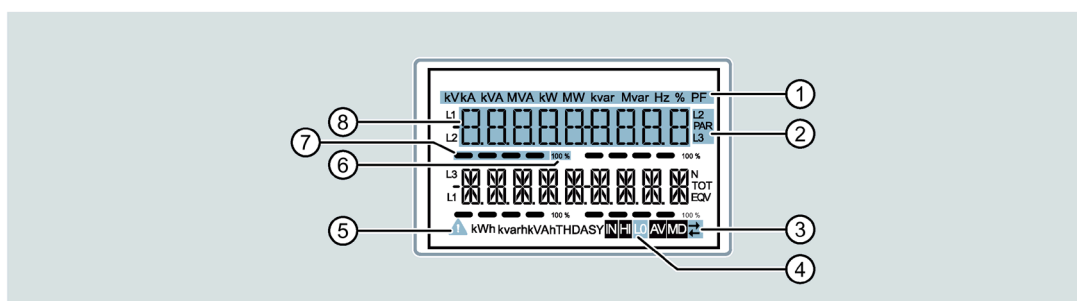

- ① Unit of measured variables
- ② Selected phase
- ③ Communication active
- ④ Subpage: Measurement type
- ⑤ Alarm icon
- ⑥ End-of-scale value
- ⑦ Bar diagram
- ⑧ Measured variable display

3.5.1 Keypad functions

You can operate the device with three keys.

The keys are assigned different functions.

The functions of the keys depend on the menu level currently in use.

"Increase" and "Decrease" keys

- Press the "Increase" or "Decrease" key:
 - Scroll between screens
 - Select available options on the display
 - Change (increase/decrease) settings
- Simultaneously press the "Increase" and "Decrease" keys: Opens and closes the various display and setup menus.

"Next" key

- Confirm the selected option
- Select the next option

Access main menu

Simultaneously press the "Increase" and "Decrease" keys.

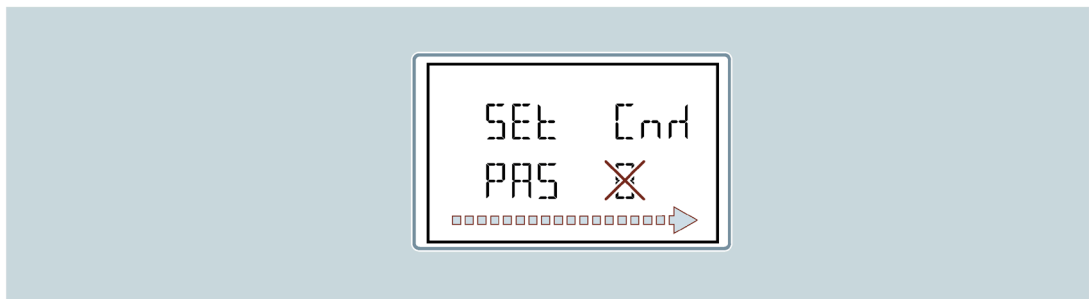

The main menu is displayed with the available options:

- SET: Access the setup menu
- CMD: Access the command menu
- PAS: Password entry

You will find more information on this in chapter Command menu (Page 64).

The selected option flashes.

The text for describing the selection scrolls in the alphanumeric display.

3.5.2 Advanced functions

Procedure

1. Press both the "Increase" and "Decrease" keys simultaneously from any display.
The device changes to the `Menu` display.
2. Press "Increase" or "Decrease" key to change to the `Set` display.
3. Confirm your selection by pressing the "Next" key.
`Enter password` appears on the display.
4. Confirm your selection by pressing the "Next" key.
5. Enter the password.
Press "Increase" or "Decrease" to change the flashing digit.
Confirm your digit selection by pressing the "Next" key.
 - If the password is incorrect, `PASS Er` appears on the display.
Press the "Next" key.
Enter the password again.
 - If the password is correct, `Advanced password ok` appears on the display.
Press the "Next" key.
6. The first entry in the following list appears on the display:
 - `CLEAR P`: Clear partial energy meters
 - `CLEAR h`: Clear partial hour counter (if activated)
 - `CLEAR d`: Clear maximum demand values (if activated)
 - `ET-DEF`: Set all parameters to the default values.
 - `SETUP`: Parameter programming (setup)
 - `INFO`: Revision and checksum of internal software
 - `ESC`: Return to normal modePress the "Increase" or "Decrease" key to scroll through the list.
7. Press the "Next" key to select a function.

Note

If you do not press the keys for more than 120 s, the menu closes automatically.

3.5.3 Selection of measured values

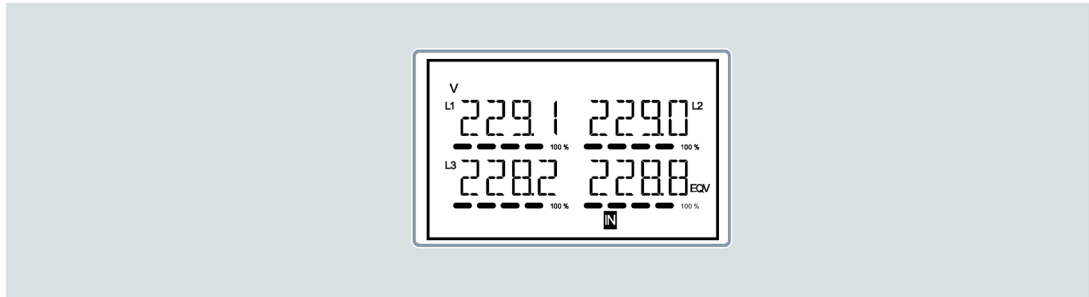

Use the "Decrease" and "Next" keys to scroll through the display pages of the measured variables in succession.

Some measurements may not be displayed on the device depending on parameterization and the connection.

Example:

If you have programmed for a system without a neutral conductor, the measurements for the neutral conductor cannot be displayed.

The "Next" key gives you access to subpages (e.g. to display the highest and lowest values recorded for the selected measurement).

The currently displayed page is indicated on the bottom right by one of the following symbols:

- **IN** = Instantaneous value

Current instantaneous value of measurement, which is displayed as a default on every change of page.

- **HI** = Highest peak

Highest value measured by the energy meter for the selected measurement. Peak values are also stored and retained when the power supply is switched off. A special command exists for resetting the stored peak values. You can find more information on this in chapter Command menu (Page 64).

- **LO** = Lowest value

Measured by the energy meter from the time when voltage was present. You can reset this value with the same command that is used for HI values. You can find more information on this in chapter Command menu (Page 64).

- **AV** = Average value

Time-integrated (average) value of measurement. You will find more information on parameter "P04 Integration" in chapter Parameter table (Page 54).

- **MD** = Max. demand value

This is not stored in volatile memory and can be reset using a special command.

Home

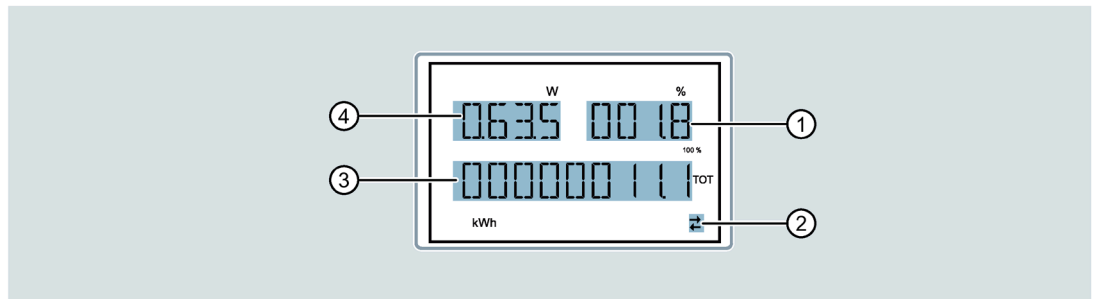

- ① Active energy percentage with reference to nominal value
- ② RS 485 communication active (flashing)
- ③ Total active energy meter
- ④ Active power

Note

After a defined time has elapsed, the system automatically returns to the pages and subpages without having to press a key.

You can also program the energy meter such that the display always shows the most recently selected page. You will find information on setting up these functions under P02 Other in chapter Parameter table (Page 54).

3.5.4 Parameterization

3.5.4.1 Set parameters (setup)

Selecting a menu

1. In the standard measurement display, simultaneously press the "Increase" and "Decrease" keys to call the main menu.
2. Select SET and press the "Next" key to open the settings menu.

The display shows the first menu level P01 on the top left with selection 01 flashing.

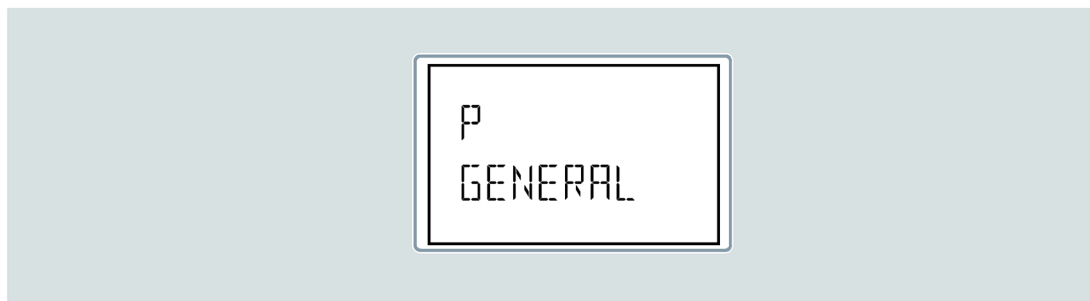

3. Use the "Increase" or "Decrease" keys to select the required menu (e.g. P01, P02, P03).
During the selection, the alphanumeric display shows a brief description of the currently selected menu.

Simultaneously press the "Increase" and "Decrease" keys to exit the setting and return to the measurement display.

Note

The following table lists the available menus, which vary depending on the device versions. Not all codes are available with all devices.

Code	Menu	Description
P01	GENERAL	Specification of the system
P02	OTHER	Language, brightness, display, etc.
P03	PASSWORD	Password activation
P04	INTEGRATION	Integration times
P05	HOUR COUNTER	Hour counter settings
P07	COMMUNICATION ¹⁾	Communication settings
P08	LIMIT THRESHOLDS	Limit values
P09	ALARMS	Alarm messages
P11	ENERGY PULSES ²⁾	Configuration of energy pulses (S0)
P13	INPUTS	Programmable inputs
P14	OUTPUTS ²⁾	Programmable outputs

¹⁾ On M-BUS and RS 485 devices only

²⁾ On S0 devices only

4. Press the "Next" key to access the selected menu.
5. Select the submenu (where applicable) and the serial parameter number.
6. After setting the required parameter, you can use the "Next" key to switch to edit mode.

Use the keys as follows:

- Press the "Increase" or "Decrease" key to change the parameter within the permissible range.
- Simultaneously press the "Increase" and "Decrease" keys to set the minimum possible value.
- Simultaneously press the "Increase" and "Decrease" keys to set the maximum possible value.
- Simultaneously press the "Increase" and "Decrease" keys to restore the factory default value.

The required value is selected.

7. Press the "Next" key to save the parameter.

The display returns to the previous menu level.

8. Press the "Increase" and "Decrease" keys repeatedly to exit and save the parameters.

The device is rebooted.

Note

If you do not press any key for a period of 2 minutes, the system exits the setup menu and returns to the standard display without saving the parameters.

Note

The devices allow you to create a backup copy in EEPROM, but only of the data which can be edited using the keys. You can write this data back into RAM if required.

You can find the backup and data restore commands in chapter Command menu (Page 64).

3.5.4.2 Energy measurement

The following pages apply especially to the energy meter:

- Active energy import and export
- Inductive or capacitive reactive energy
- Apparent energy

Each page shows the total value and the partial value. You can reset the partial value using the Command menu (Page 64).

Continuous display of the unit of measurement means that the measurement display for energy (import) is positive.

You can also activate the display of negative energies (export) by setting parameter P02.09 to ON.

These energies are highlighted by flashing of the measurement unit and by the character "-" and can be displayed after the import energies by pressing the "Decrease" key.

- Export: Display flashing
- Import: Display not flashing.

If the display of energy for the individual phases is activated (P02.10 = ON), the display shows three independent additional pages (one page per phase), including total and partial energy.

If programmable input P13.01 is set to TAR-A, all the specified energy meters are also present separated according to tariff 1 and tariff 2. These meters are displayed on the subpages of the system counter. You can find more information in chapter Tariffs (Page 51).

3.5.4.3 Tariffs

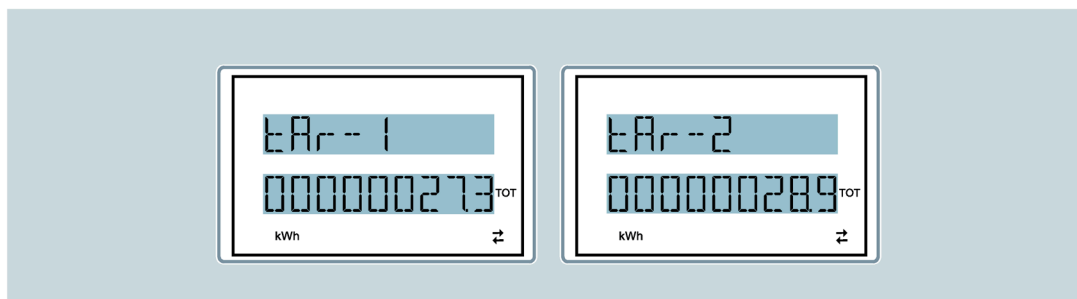

In addition to the total and partial energies, two independent tariffs can be managed for energy measurement.

- The tariff is normally selected using the digital input but can be selected via the communication protocol as an option.
- The TAR-A input function is available for selecting the two tariffs. Activate the TAR-A input function to make the selection shown in the table:

TAR-A	Tariff
ON	1
OFF	2

The device has a programmable AC voltage input.

- The default function setting is TAR-A, which makes selection between tariffs 1 and 2 possible.
- The text $tAr-1$ or $tAr-2$ flashes to indicate the selected tariff and the increasing counter reading.
- The counter readings for the tariffs are displayed as subpages of the system counters (total and phase, if activated).
- For devices with Modbus, you can select the active tariff using a special command in the Modbus protocol. You can find more information in chapter Modbus address table for three-phase devices 80 A with Modbus interface (Page 91).

3.5.4.4 Hour counter

When the hour counter is activated, the devices display the hour counter page in the following format:

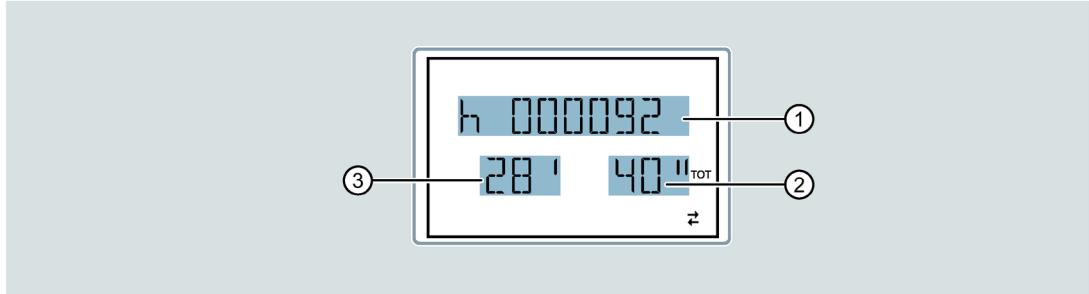

- ① Hours
- ② Seconds
- ③ Minutes

The energy meter has one total hour counter and four partial hour counters. You can reset and activate both hour counters using various sources. You can find more information on this in chapter Parameter table (Page 54).

3.5.4.5 Limit threshold status display (LIMx)

If limit thresholds are activated, the devices display the page with the corresponding status and the format shown in the diagram below:

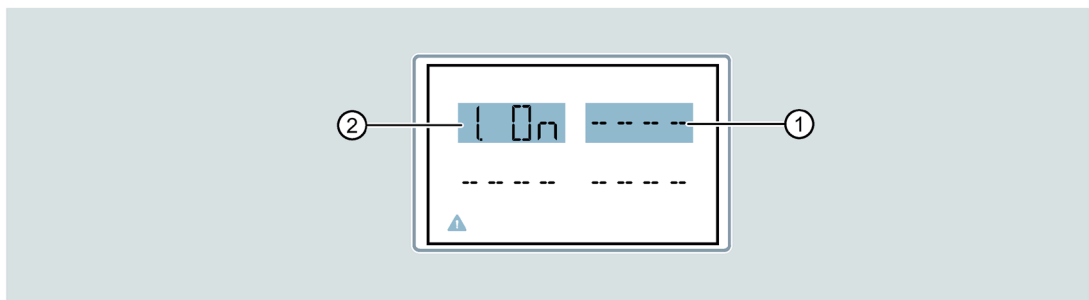

- ① Limit thresholds deactivated
- ② Limit thresholds activated
- If the limit threshold is activated, the word ON flashes.
- If the function is deactivated, the word OFF is displayed continuously.
- If no limit threshold is programmed, dashes are displayed.

You can find more information on limit thresholds in chapter Parameter table (Page 54).

3.5.4.6 Alarm display

If alarms are activated, the device displays the page with the corresponding status and the following format:

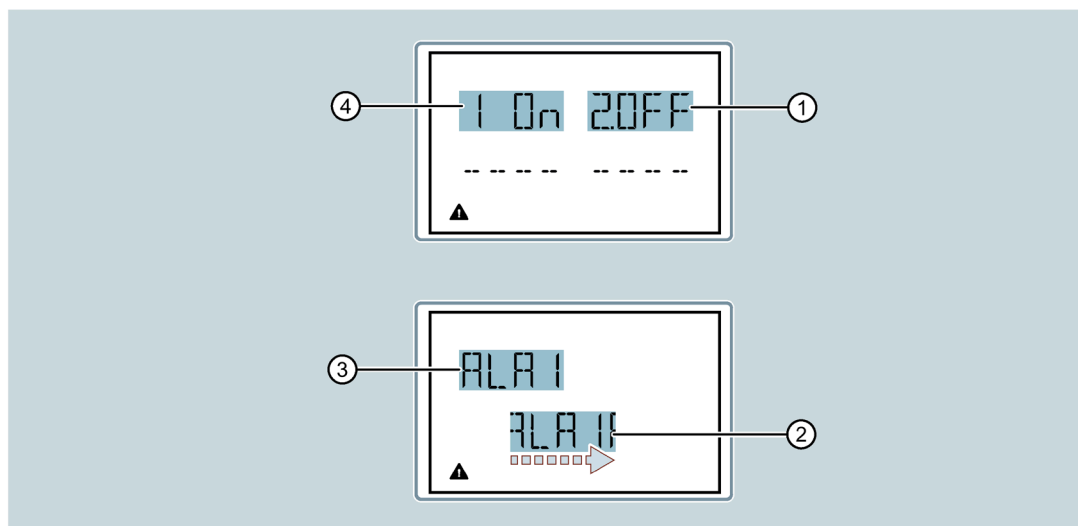

- ① Alarm 2 activated/deactivated
- ② Alarm text activated
- ③ Alarm code activated
- ④ Alarm 1 activated/deactivated

You can find more information on parameter P09 in chapter Parameter table (Page 54).

- If the alarm is activated, the word **ON** flashes with the triangle symbol. If the alarm is not activated, the word **OFF** is displayed continuously.
- If no alarm is programmed, dashes are displayed. After approx. 3 s, the scrolling text for the alarm programmed in parameter P09.n.05 appears.
- If several alarms are active, the texts are displayed in succession.
- You can use parameter P02.14 for the Other menu to make the backlighting of the display flash in the event of an alarm and to make it more obvious that a fault has occurred.
- The alarm reset method depends on parameter P09.n.03. The parameter determines whether it is defined automatically or manually via the command menu (parameter C.07) if alarm conditions are not fulfilled. You can find more information in chapter Command menu (Page 64).

3.5.4.7 Parameter table

The following tables show all the available programming parameters with the possible setting range, the factory settings and a description of the parameter function.

The description of the parameters visible on the display can deviate from the details in the table in some cases due to the restricted number of available characters. The parameter code is the most reliable means of reference.

The parameter selections depend on the device version.

P01 General

		Unit	Default	Range
P01.01	Primary current of the current transformer	A	5	1 ... 10000
P01.02	Secondary current of the current transformer	A	5	1 ... 5
P01.03	Nominal voltage	V	AUT	<ul style="list-style-type: none"> • AUT • 220 ... 415
P01.04	Rated power	kW	AUT	<ul style="list-style-type: none"> • AUT • 1 ... 10000
P01.05	Wiring configuration	–	L1-L2-L3-N	<ul style="list-style-type: none"> • L1-L2-L3-N • L1-L2-L3 • L1-L2-L3-N BIL • L1-L2-L3 BIL • L1-N-L2 • L1-N

P02 Other

		Unit	Default	Range
P02.01	Language	–	English	<ul style="list-style-type: none"> • English • Italiano • Francais • Espanol • Portuguese • Deutsch
P02.02	High backlight level	%	100	0 ... 100
P02.03	Low backlight level		30	0 ... 50
P02.04	Low backlight delay	s		5 ... 600
P02.05	Default page return		60	<ul style="list-style-type: none"> • OFF • 10 ... 600

		Unit	Default	Range
P02.06	Default page	–	W + kWh	<ul style="list-style-type: none"> • VL-L • VL-N • ...
P02.07	Default subpage		INST	<ul style="list-style-type: none"> • INST • HI • LO • AVG • MD
P02.08	Display update time	s	0.5	0.1 ... 5.0
P02.09	Exported energy measure	–	OFF	<ul style="list-style-type: none"> • OFF • ON
P02.10	Phase energy measure			
P02.11	U/I asymmetry measure			
P02.12	THD harmonic measure			<ul style="list-style-type: none"> • OFF • THD
P02.13	Power unbalance measurement			<ul style="list-style-type: none"> • OFF • ON
P02.14	Backlight flash when in alarm			
P02.15	Reactive power calculation			<ul style="list-style-type: none"> • TOT • FUND

P02.05 If OFF is set, the display always shows the most recently selected menu page. If it is set to a value, the display returns to the page set using P02.06 after this time has elapsed.

P02.06 Number of the page that is automatically displayed as soon as time P02.05 has elapsed since a key was pressed.

P02.07 Type of page to which the display returns after P02.05 has elapsed.

P02.09 Permits the measurement and display of exported energies (generated in the direction of the grid).

P02.10 Permits the measurement and display of energies according to individual phases.

P02.11 Permits the measurement and display of voltage and current unbalances.

P02.12 Activates the measurement and display of voltage and current THDs (% harmonic distortion).

P02.13 Permits the calculation and display of phase unbalances.

P02.14 In the event of an alarm, the display backlighting flashes to highlight the fault.

P02.15 Selects the calculation method for reactive power.

- TOT = The reactive power contains the harmonic components.
In this case: $P_{\text{reactive}}^2 = P_{\text{apparent}}^2 - P_{\text{active}}^2$
- FUND = The reactive power only contains the fundamental component.
In this case: $P_{\text{reactive}}^2 \leq P_{\text{apparent}}^2 - P_{\text{active}}^2$

P03 Password

		Unit	Default	Range
P03.01	Password Enable	–	OFF	<ul style="list-style-type: none"> • OFF • ON
P03.02	Password User		1000	0 ... 9999
P03.03	Password advanced		2000	

P03.01 When OFF is set, the password setting is deactivated and access to settings and the command menu is unrestricted. You can find more information in chapter Command menu (Page 64).

P03.02 When P03.01 is active, value for specifying user access.

P03.03 Similar to P03.02, administrator access.

P04 Integration

		Unit	Default	Range
P04.01	Averaging	–	Shift	<ul style="list-style-type: none"> • Fixed • Shift • Bus
P04.02	Power demand values	min	15	1 ... 60
P04.03	Current demand values			
P04.04	Voltage demand values		1	
P04.05	Frequency demand values			

P04.01 Integrated measurement calculation mode

- **Fixed** = The instantaneous measurements are integrated for the set time. Every time this set time elapses, the integrated measurement is updated with the result of the most recent integration.
- **Shift** = The instantaneous measurements are integrated for a time = 1/15 of the set time. Every time this interval elapses, the oldest value is replaced by the newly calculated value. The integrated measurement is updated every 1/15 of the set time. A time shift window with the 15 most recent calculated values which correspond to the set time is taken into account here.
- **Bus** = As a fixed mode; however, the integration intervals are defined by means of synchronization commands sent on the serial bus.

P04.02 Average (AVG) integration time of measurement for active, reactive and apparent power.

P04.03 Average (AVG) integration time of currents.

P04.04 Average (AVG) integration time of voltages.

P04.05 Average (AVG) integration time of frequency.

P05 Hour counter

		Unit	Default	Range
P05.01	Activate total hour counter	–	ON	OFF ON
P05.02	Activate partial hour counter 1			<ul style="list-style-type: none"> • OFF • ON • LIMx
P05.03	Hour counter channel number 1		1	1 ... 4
P05.04	Activate partial hour counter 2		ON	<ul style="list-style-type: none"> • OFF • ON • LIMx
P05.05	Hour counter channel number 2		1	1 ... 4
P05.06	Activate partial hour counter 3		ON	<ul style="list-style-type: none"> • OFF • ON • LIMx
P05.07	Hour counter channel number 3		1	1 ... 4
P05.08	Activate partial hour counter 4		ON	<ul style="list-style-type: none"> • OFF • ON • LIMx
P05.09	Hour counter channel number 4		1	1 ... 4

P05.01 The hour counters are deactivated when OFF is set. The hour counters do not appear on the display.

- P05.02, P05.04, P05.06, P05.08
- The partial hour counter (1, 2, 3, or 4) cannot be incremented when OFF is set.
 - When ON is set, the partial hour counter is incremented when the energy meter is exporting energy.
 - If the partial hour counter is linked to one of the internal variables (LIMn), the partial hour counter is only incremented if this condition is true.

P05.03, P05.05, P05.07, P05.09 Example:

If the partial hour counter needs to count the time while one measurement is above a particular threshold that was defined by LIM3, program LIMx in the previous parameter and enter "3" in this parameter.

P07 Communication for devices with Modbus interface only

		Unit	Default	Range
P07.01	Address	–	01	01 ... 255
P07.02	Baud rate	bps	9600	<ul style="list-style-type: none"> • 1200 • 2400 • 4800 • 9600 • 19200 • 38400 • 57600 • 115200
P07.03	Data format. 7-bit settings only available for the ASCII protocol.	–	8 bit - n	<ul style="list-style-type: none"> • 8 bit, no parity • 8 bit, odd • 8 bit, even • 7 bit, odd • 7 bit, even
P07.04	Stop bits		1	1 ... 2
P07.05	Protocol		Modbus RTU	<ul style="list-style-type: none"> • Modbus RTU • Modbus ASCII

P07.03 Data format. 7-bit settings only available for the ASCII protocol.

P07.04 Number of stop bits

P07.05 Selection of communication protocol

P07 Communication for devices with M-Bus interface only

		Unit	Default	Range
P07.01	Primary address	–	01	01 ... 250
P07.02	Secondary address		Serial number	<ul style="list-style-type: none"> • 00000000 • 99999999
P07.03	Baud rate		2400	<ul style="list-style-type: none"> • 300 • 600 • 1200 • 2400 • 4800 • 9600 • 19200 • 38400

- P07.01 Primary address for M-Bus network
 P07.02 Secondary address for M-Bus network
 P07.03 Speed of communication

P08 Limit thresholds (LIMn, n = 1 to 4)

Note

This menu is divided into 4 sections for limit thresholds LIM 1 ... 4 in P08.n.01. The menu defines the energy meter measurement to which the limit threshold applies.

		Unit	Default	Range
P08.n.01	Reference measure	–	OFF	OFF ... (measures)
P08.n.02	Function		Max	<ul style="list-style-type: none"> • Max • Min • Max + Min
P08.n.03	Upper threshold		0	–9999 ... +9999
P08.n.04	Multiplier		x1	/100 ... x10k
P08.n.05	Delay	s	0	0.0 ... +1000.0
P08.n.06	Lower threshold	–		–9999 ... +9999
P08.n.07	Multiplier		x1	/100 ... x10k
P08.n.08	Delay	s	0	0.0 ... +1000.0
P08.n.09	Status	–	OFF	<ul style="list-style-type: none"> • OFF • ON
P08.n.10	Reset mode			

P08.n.02 Defines the energy meter measurement to which the limit threshold applies.

- **Max** = LIMn active if the measurement exceeds P08. P08.n.03 is the reset threshold.
- **Min** = LIMn active if the measurement falls below P08. P08.n.06 is the reset threshold.
- **Min + Max** = LIMn active if the measurement exceeds P08.n.03 or falls below P08.n.06.

P08.n.03 Defines the upper threshold resulting from the multiplication of the value P08.n.03 , by P08.n.04.

P08.n.04

P08.n.05 Triggering delay for upper threshold.

P08.n.06 Defines the lower threshold resulting from the multiplication of the value P08.n.06 , by P08.n.07.

P08.n.07

P08.n.08 Triggering delay for lower threshold.

P08.n.09 Permits inversion of the status of limit threshold LIMn.

- P08.n.10
- **ON** = Threshold value is saved and must be reset manually.
 - **OFF** = Threshold value is saved and is reset automatically.

P09 Alarms (ALAn, n = 1 to 4)**Note**

This menu is divided into 4 sections for alarms ALA1 ... 4.

		Default	Range
P09.n.01	Alarm source	OFF	<ul style="list-style-type: none"> • OFF • LIMx
P09.n.02	Channel number (n)	1	1 ... 4
P09.n.03	Reset mode	OFF	<ul style="list-style-type: none"> • OFF • ON
P09.n.04	Priority	Low	<ul style="list-style-type: none"> • Low • High
P09.n.05	Text	ALAn	(Freely definable text for alarm, max. 16 characters)

P09.n.01 Signal which triggers the alarm when a threshold value (LIMx) is exceeded.

P09.n.02 Channel number (n), with reference to the previous parameter.

P09.n.03 • ON = Alarm is saved and must be reset manually.
 • OFF = Alarm is saved and is reset automatically.

P09.n.04 • If the alarm has a high priority, its activation automatically switches the display to the alarm page and displays the alarm icon.
 • If the alarm has a low priority, the page does not change and it is displayed with the "Information" symbol.

P11 Energy pulses (PUL1 and PUL2) only for devices with S0 interface/digital outputs

Note

This menu is divided into two sections for pulses PUL1 and PUL2.

		Unit	Default	Range
P11.n.01	Measured variable for pulse generation	–	OFF	<ul style="list-style-type: none"> • OFF • Wh+ • Wh– • varh+ • varh– • VAh
P11.n.02	Number of pulses	Pulse/ kWh	10	<ul style="list-style-type: none"> • 100 • 10 • 1 • 0.1
P11.n.03	Duration of pulses	s	0.10	0.01 ... 1.00

P11.n.01 Measured variable for pulse generation

P11.n.02 Number of pulses

P11.n.03 Duration of pulses

P13 Input

		Default	Range
P13.01	Input function	–	<ul style="list-style-type: none"> • OFF • LOCK • TAR-A • C01 ... C08
P13.02	Normal status		<ul style="list-style-type: none"> • OFF • ON
P13.03	Delay "ON"	s	1 ... 4
P13.04	Delay "OFF"		

P13.01 Input function:

- OFF = Input deactivated.
- LOCK = Settings lock. Prevents access to both levels.
- TAR-A = Selects the energy tariff. You can find more information in chapter Tariffs (Page 51).
- C01 ... C08 = When this input is activated (during rise time), the corresponding command is active in the command menu. You can find more information in chapter Command menu (Page 64).

P13.02 Enter normal status. Permits inversion of activation logic.

P13.03 Delay setting for "ON".

P13.04 Delay setting for "OFF".

P14 Outputs (OUT1 and OUT2) only for devices with S0 interface/digital outputs

Note

This menu is divided into two sections for outputs OUT1 and OUT2.

		Unit	Default	Range
P14.n.01	Output function	–	OFF	<ul style="list-style-type: none"> • OFF • Wh+ • Wh– • varh+ • varh– • VAh
P14.n.02	Channel number		1	1 ... 4
P14.n.03	Normal status		OFF	<ul style="list-style-type: none"> • OFF • ON
P14.n.04	Delay "ON"	s	0.0	0.0 ... 6000.0
P14.n.05	Delay "OFF"		0.0	

P14.n.01 Output function:

- OFF = Output deactivated.
- ON = Output is always activated when the measuring device is switched on.
- SEQ = Output activated in the event of phase sequence error.
- LIM - ALA = Output activated in the event of upward violation of limit or alarm.
- PUL = Output used as pulse generator as per P11.

P14.n.03 Output of normal status. Permits inversion of activation logic.

P14.n.04 Delay setting for "ON".

P14.n.05 Delay setting for "OFF".

3.5.4.8 Command menu

The command menu allows you to perform occasional operations (e.g. to reset measured variables and counters).

After entering the password for the extended level, you can also use the command menu to perform a number of automatic operations which are useful for the configuration of the device.

The following table shows the functions that are available in the command menu, separated according to the required access level.

Note

C.11 cannot be selected with MID devices.

Code	Command	Access level	Description
C.01	RESET HI-LO	User level/ Administrator	Resets the HI and LO values of all measurements.
C.02	RESET MAX DEMAND		Resets the maximum demand values for all measurements.
C.03	RESET PAR.ENERGY		Resets the partial energy meters.
C.04	RESET PAR.HOURS		Resets the partial hour counters.
C.06	RESET TARIFFS		Resets the energy meters for tariffs 1 and 2.
C.07	RESET ALARMS		Resets alarms.
C.08	RESET LIMITS		Resets limit values.
C.11	RESET TOT.ENERGY		Administrator
C.12	RESET TOT.HOURS	Resets the total hour counter.	
C.13	SETUP TO DEFAULT	Restores all the factory settings for the device.	
C.14	BACKUP SETUP	Saves a backup copy of all setup parameters.	
C.15	RESTORE SETUP	Loads the settings from the backup copy.	
C.16	WIRING TEST	Runs the test to check whether the device is connected correctly. See chapter Wiring test (Page 65).	

1. Select the required command.
2. Press the "Next" key to execute the command.
3. Press the "Next" key again to execute the command.
4. Press **MENU** to cancel command execution.
5. Simultaneously press the "Increase" and "Decrease" keys to exit the command menu.

3.5.5 Wiring test

You can use the wiring test to check whether the energy meter has been installed correctly.

Requirements

In order to run the wiring test, the energy meter must be connected to an active system and the following conditions must be fulfilled:

- Three-phase system with all phases ($V > 187 \text{ V AC PH-N}$)
- Minimum current flow in each phase ($> 1\%$ of current transformer full-scale deflection)
- Positive energy flows (normal system in which the inductive load draws power from the supply)

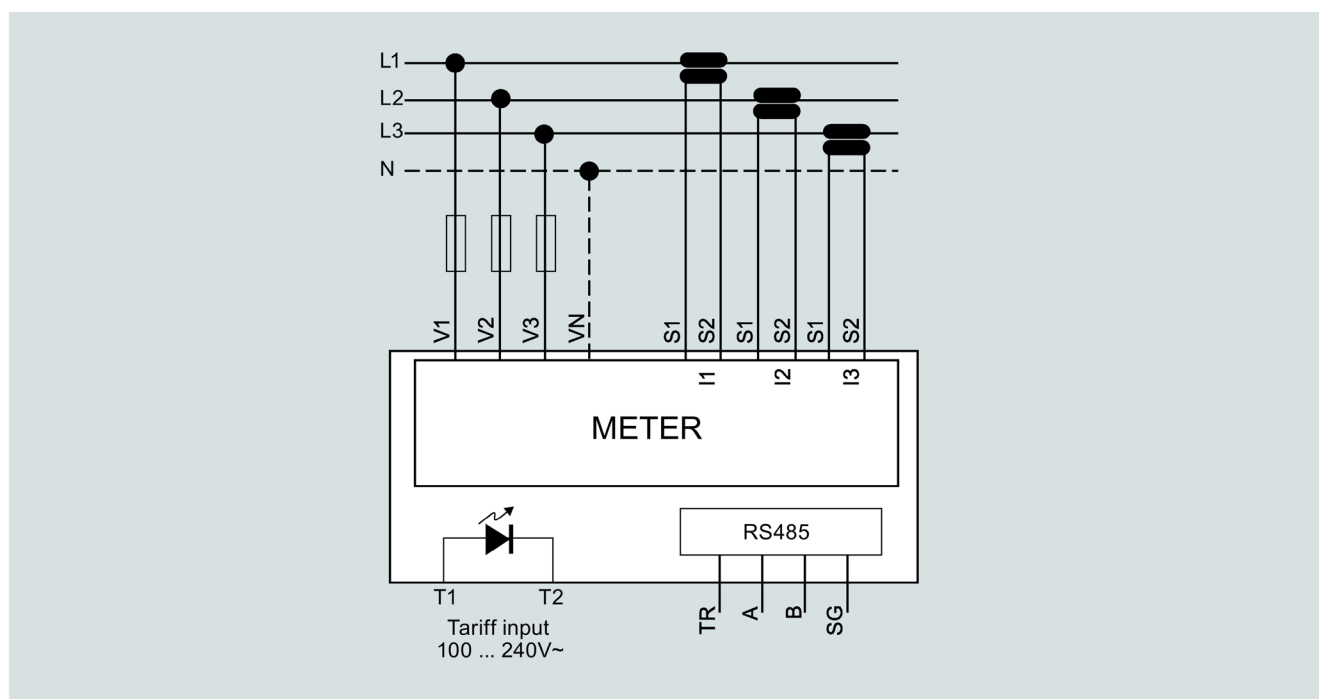

3.6 Supporting software

Run wiring test

1. Call up the command menu. You can find more information in chapter Command menu (Page 64).
2. Select command C.16 as described in the instructions in chapter Command menu (Page 64).
3. Check the following points:
 - Reading of the three voltages
 - Phase sequence
 - Voltage unbalance
 - Reverse polarity of one or more current transformers
 - Mismatch between voltage/current phases

If the test is not successful, the display indicates the reason why it has failed.

3.6 Supporting software

3.6.1 powermanager

You can use the powermanager energy management software to acquire, monitor, evaluate, display and archive the energy data of the measuring device.

powermanager functions

- Tree view of the customer's system (project tree)
- Measured value display with pre-defined user views
- Alarm management
- Demand curve
- Reporting, different report types (e.g. cost center report)
- Load monitoring of reaction plans
- Power peak analysis (available as of powermanager V3.0 SP1)
- Support of distributed plants (systems)
- Archiving system
- User administration

3.6.2 powerconfig

Note

Relevant only for devices with an RS 485 interface.

The powerconfig software is the combined commissioning and service tool for communication-capable measuring devices and circuit breakers from the SENTRON family.

The PC-based tool facilitates parameterization of the devices by saving a great deal of time, in particular when several devices have to be set up.

You can use powerconfig to parameterize and operate the measuring devices via various communication interfaces, and to document and monitor measured values.

powerconfig functions

- The software combines the following functions:
 - Parameterization
 - Documentation
 - Operation
 - Monitoring
- User-friendly documentation of settings and measured values
- Clear presentation of the available parameters including plausibility testing of the input values
- Display of the available device statuses and measured values in standardized views
- Project-oriented storage of device data
- Consistent operation and usability
- Support for various communications interfaces (Modbus RTU, Modbus TCP, PROFIBUS, PROFINET)
- Updating of device firmware (device-dependent)
- Loading of language packs (device-dependent)

Note

You launch the Online Help in SENTRON powerconfig by pressing the F1 key.

Description

3.6 Supporting software

Installation/removal

4.1 Installation location

<p>! WARNING</p> <p>Possible risk of death due to damaged device!</p> <p>Using devices when they are damaged may result in death, serious injury, or property damage.</p> <ul style="list-style-type: none"> • Do not install damaged devices. • Do not start up damaged devices.

<p>NOTICE</p> <p>Material damage due to condensation!</p> <p>Sudden fluctuations in temperature can lead to condensation. Condensation can affect the function of the device.</p> <p>Store the device in the operating room for at least two hours before commencing installation.</p>
--

The PAC1600 energy meter is mounted on a TH35 rail (complying with EN 60715) and is intended for installation in permanently installed systems within closed rooms.

Environmental conditions

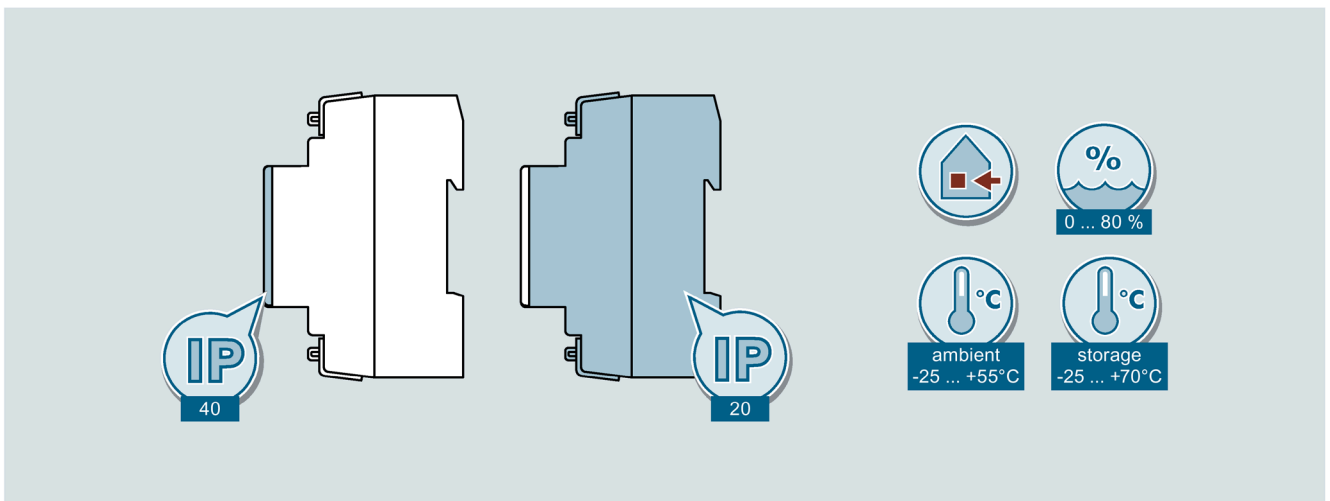

4.2 Installing/removing single-phase device

The installation and removal of a single-phase device is similar to that of a three-phase device.

4.3 Installing three-phase device

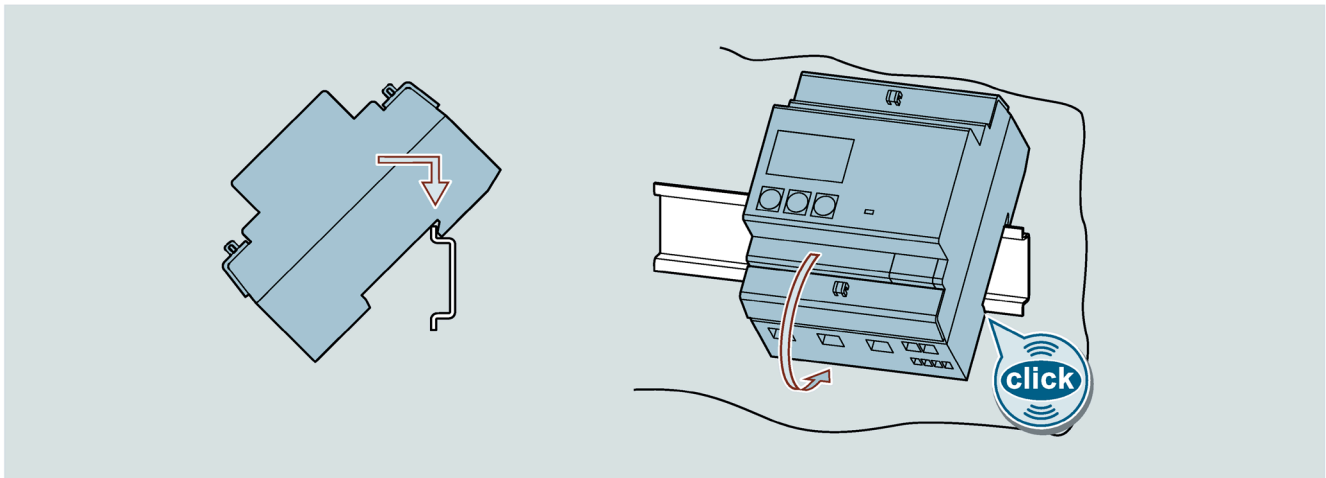

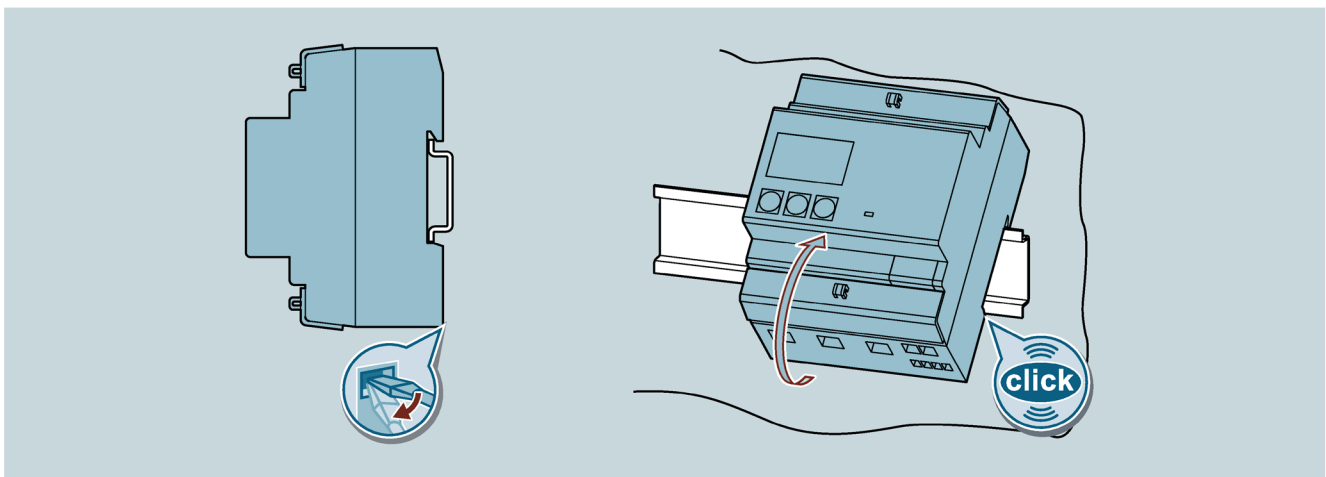

4.4 Installing/removing three-phase device



Safety instructions

 DANGER
Risk of death due to hazardous voltage! Before starting work, disconnect the system and the device from the power supply.

 DANGER
Risk of death due to electric shock and arc flashover! For the 5 A device, it is only possible to measure the current via external current transformers. When using the current transformers, the circuit is not protected by a fuse. <ul style="list-style-type: none">• Switch off and lock out all power supplying this equipment before working on the device.• Never open the secondary circuit of the current transformers under load.• Short circuit the secondary current terminals of the current transformer before removing this device.• Always follow the safety instructions for the current transformers used.

 WARNING
Possible risk of death due to damaged device! Using devices when they are damaged may result in death, serious injury, or property damage. <ul style="list-style-type: none">• Do not install damaged devices.• Do not start up damaged devices.

NOTICE
Equipment damage due to lack of fusing Non-fused voltage measuring inputs may lead to device and equipment damage. Always protect the device with an IEC approved fuse or with an IEC approved miniature circuit breaker.

Note

RS 485 termination recommended

In order to avoid reflection on the bus cable, we recommend fitting a 120 Ω terminating resistor at the beginning and end of the bus cable.

To establish Modbus RTU communication, the communication parameters must be known. These include baud rate and format. Furthermore, you must enter the slave address in the PAC1600 device.

Qualified personnel

Some of the following tasks are carried out when hazardous voltage is present. For this reason, they must only be carried out by qualified personnel who are familiar with the safety regulations and precautions and who follow the safety regulations and precautions.

- Wear the prescribed protective clothing.
- Observe the general equipment regulations and safety regulations for working with high-voltage installations (e.g. DIN VDE, NFPA 70E), as well as national or international regulations.
- Ensure that the limits given in the technical data are not exceeded, not even during commissioning or testing.
- Short circuit the secondary connections of intermediate current transformers at the transformers before interrupting the current lines to the device.
- Test the polarity and the phase assignment of the instrument transformers.
- Before connecting the device, ensure that the system voltage matches the voltage specified on the type plate.
- Before commissioning, ensure that all connections have been made correctly.
- Before power is applied to the device for the first time, you must place it in the operating room for a period of at least two hours. This allows it to reach temperature balance and avoids humidity and condensation.

See also

PAC4200 manual (<https://support.industry.siemens.com/cs/ww/en/view/34261595>)

5.1 Connection example for Modbus RTU

Connection of PAC1600 devices to PAC4200 as Modbus RTU / TCP gateway

PAC1600		PAC1600		PAC1600		PAC4200/RS 485 expansion module	
TR	---	TR		TR		Ter	---
A	-----	A	-----	A	-----	B	
B	-----	B	-----	B	-----	A	---
SG	-----	SG	-----	SG	-----	Com	

A maximum of 32 nodes are permitted in one line.

Depending on the baud rate used, the maximum length of the entire communication cabling is 1200 m.

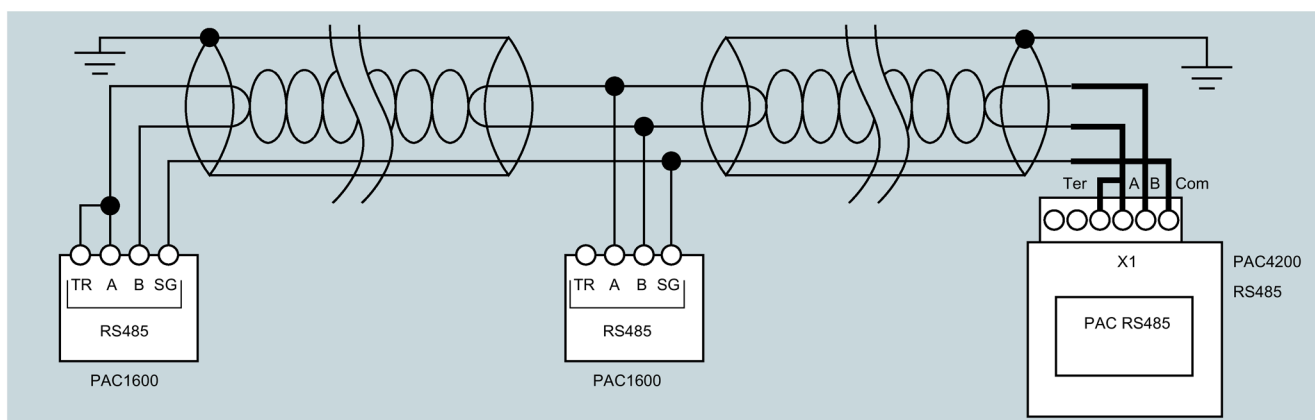

5.2 Connecting single-phase device

NOTICE

Irreparable device damage

The wrong system connection can cause irreparable damage to the device.

Before connecting the PAC1600, ensure that the local power supply conditions match the specifications on the type plate.

Procedure

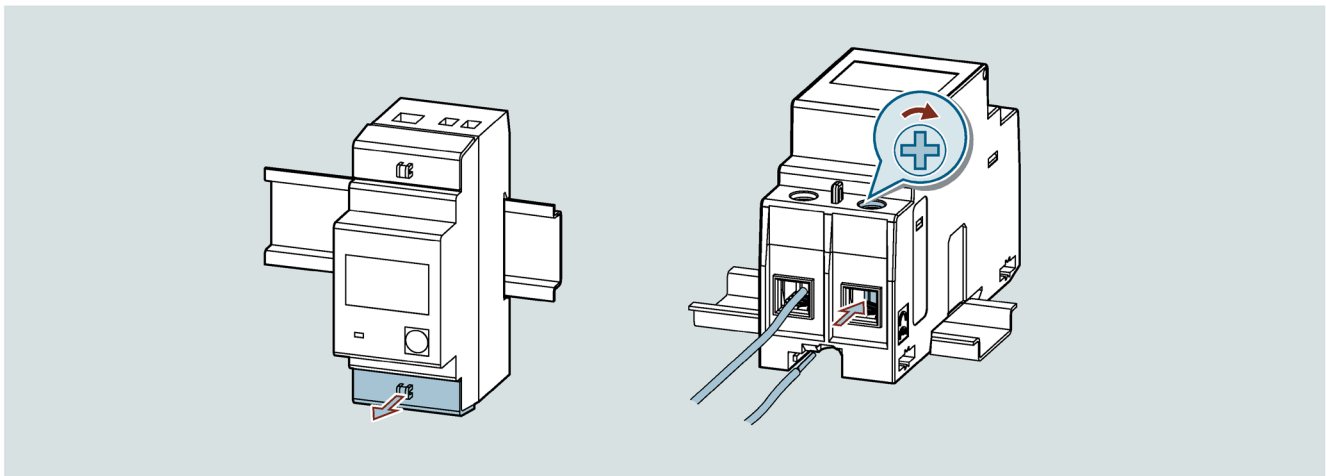

Circuit diagram of single-phase device (outputs depend on device type)

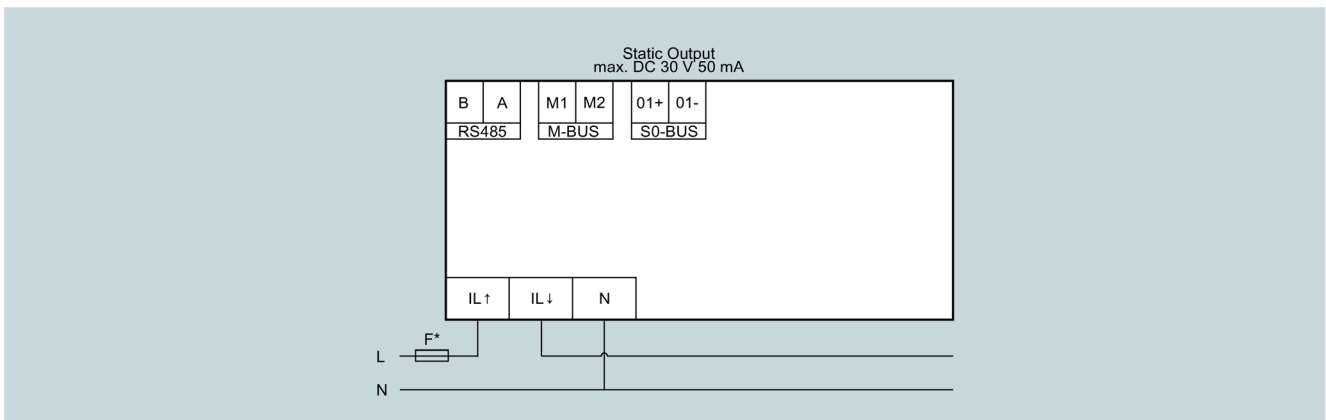

* The fuse in the voltage measuring input is only used for cable protection.

	Tightening torque	Cable cross-section (mm ²)
L1 / N 63A	1.8 ... 2.2 [15.9 ... 19.5]	2.5 ... 16
RS 485 / S0 / M-Bus	0.14 ... 0.16 [1.2 ... 1.4]	0.5 ... 4

Parameterization

You can find information on parameterization in chapter Keypad functions (Page 19).

5.3 Connecting three-phase device

NOTICE

Irreparable device damage

The wrong system connection can cause irreparable damage to the device.

Before connecting the PAC1600, ensure that the local power supply conditions match the specifications on the type plate.

Note

RS 485 termination is recommended!

In order to avoid reflection on the bus cable, we recommend fitting a 120 Ohm terminating resistor at the beginning and end of the bus cable.

To establish MODBUS RTU communication, the communication parameters must be known. These include baud rate and format. Furthermore, you must enter the slave address in the device.

5.3 Connecting three-phase device

Procedure

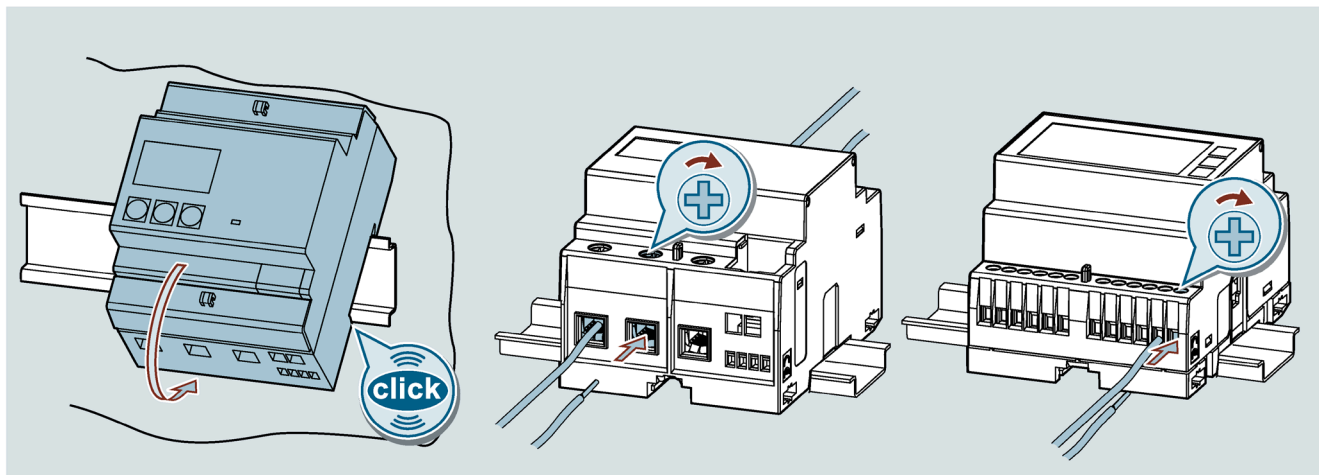

Circuit diagram of three-phase device 5 A (outputs depend on device type)

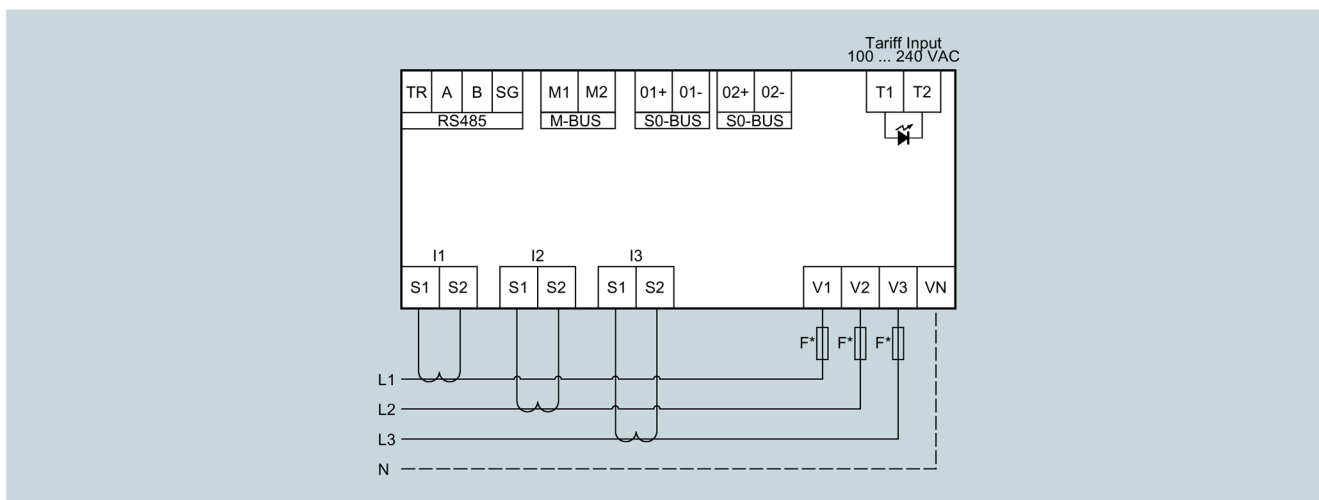

* The fuse in the voltage measuring input is only used for cable protection.

	Tightening torque	Cable cross-section (mm ²)
I1 / I2 / I3 / 5 A and RS 485 / M-Bus / SO	0.40 ... 0.48 (3.5 ... 4.2)	0.2 ... 2.5
Tariff input and voltage inputs	0.7 ... 0.8 (6.2 ... 7.1)	0.2 ... 4.0

Circuit diagram of three-phase device 80 A (outputs depend on device type)

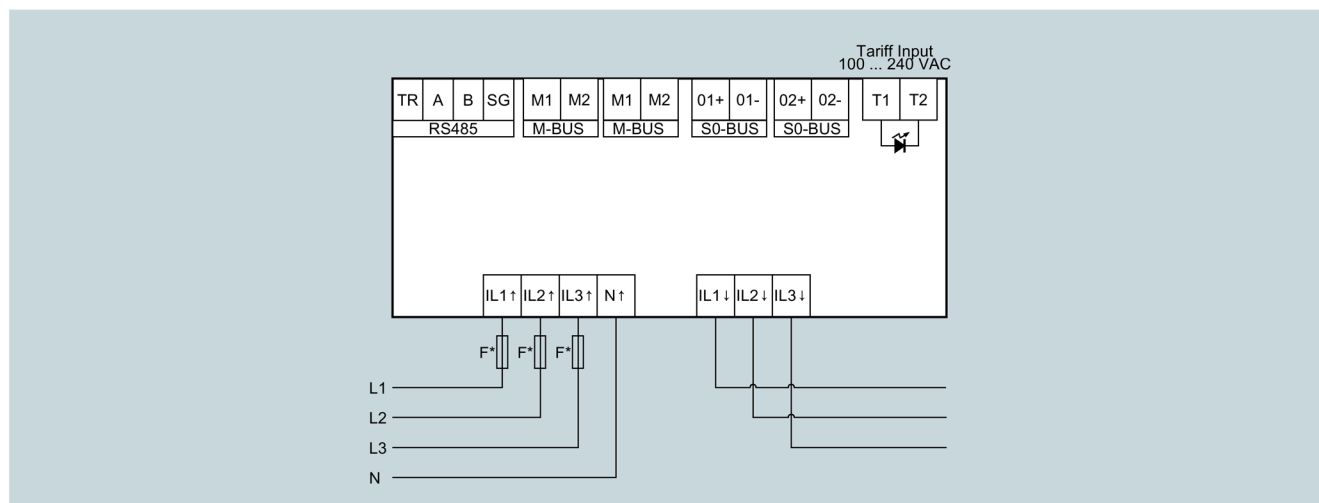

* The fuse in the voltage measuring input is only used for cable protection.

	Tightening torque	Cable cross-section (mm ²)
L1 / L2 / L3 / N / 80 A	1.8 ... 2.2 (15.9 ... 19.5)	2.5 ... 25
Tariff input	0.44 ... 0.53 (3.9 ... 4.7)	0.2 ... 2.5
RS 485 / M-Bus / S0	0.14 ... 0.16 (1.2 ... 1.4)	0.2 ... 2.5

Parameterization

Parameterization of the devices is described in chapter Parameterization (Page 33).

5.4 Wiring test

If the wiring is incorrect and the device detects an energy flow in the wrong direction, the message **Err 3** appears on the display.

This error is either caused by incorrect wiring of the current inputs (terminals L ↑ and L ↓) or by incorrect voltage wiring (terminals N - L ↑).

Energy is not counted under these conditions.

Commissioning

6.1 Overview

Prerequisites

- The device has been installed.
- The device has been connected in accordance with the possible connection methods.

Steps for starting up the device

NOTICE**Irreparable device damage!**

The wrong system connection can cause irreparable damage to the device, or can lead to device failure or malfunctions.

- Before connecting the PAC1600, ensure that the local power supply conditions match the specifications on the type plate.
- Before starting up the PAC1600, check that all connections are correct.

Note

When performing an insulation test of the entire installation with AC or DC, you must disconnect the device before starting the test.

1. Apply the measuring voltage. You can find more information on this in chapter Applying the measuring voltage (Page 80).
2. Parameterize the device. You will find more information on this in the chapter Parameterizing with powerconfig (Page 80).
3. Check the measured values.

6.2 Applying the measuring voltage



Risk of death due to excessively high voltage!

Death, serious injury, or property damage may result if the nominal voltage ranges are exceeded.

Always observe the limits specified in the technical data and on the type plate.

The device is supplied with power via the measuring voltage.

Please consult chapter Technical data (Page 99) or the type plate for the type and level of the possible supply voltage.

You can find more information in chapter Connection (Page 71).

6.3 Parameterizing with powerconfig

You can download the powerconfig configuration software from the Industry Online Support website via the link (<https://support.industry.siemens.com/cs/ww/en/view/63452759>).

Information on how to use powerconfig can be found in the Online Help of the configuration software or by contacting Technical Support.

You launch the Online Help in powerconfig by pressing the F1 key.

Prerequisite (RS 485 devices only)

You can only connect RS 485 devices to powerconfig. To connect RS 485 devices to powerconfig, an RS 485 interface and a supply voltage must be available.

In order to configure the PAC1600 measuring device, you must connect the measuring voltages and set up communication with the device.

Establishing connection to the device

To establish a connection to the PAC1600, proceed as follows:

1. Connect the PAC1600 device to the PC.
2. Open the powerconfig configuration software.
3. Click the **Search for accessible devices** button on the toolbar or press the F11 key.

The "Search for accessible devices" window is displayed.

4. In the "Search for accessible devices" window, click the **Serial** tab if you want to access the device via an RS 485 interface.

The "Serial" view appears.

5. Select PAC1600 in the **Search for device** option.
6. Enter the communication parameters:
 - COM port
 - Address
 - Baud rate
 - Format
 - Protocol
7. Click the **Start search** button.

All devices found are shown in the "Result" window.
8. Select the required device.
9. Click the **Create devices** button.

The selected device is added.
10. In the **Views** menu, select the submenu "Parameters".

The "Parameters" window is displayed.
11. In the "Properties" window, click the **Load to PC** button.

The configuration is loaded from the device to the PC.

Parameterizing the device

The parameters are entered and changed in offline mode.

To switch between online and offline mode, click **Activate online view** in the **Options** menu or press the F12 key.

Set the required basic parameters.

Make use of the Online Help in powerconfig.

In order to load the parameters to the device, proceed as follows:

1. Integrate the device in powerconfig.
2. In the **Views** menu, select the submenu **Parameters** or alternatively press the "Ctrl" and "Pos1" keys simultaneously.

The "Parameters" window is displayed.
3. In the "Parameters" window, click the **Load to PC** button.

The set parameters are loaded to the device.

4. Check the device parameters and adjust them if necessary.

Note

You can only change parameters in offline mode.

You can find more information on parameterization in the powerconfig Online Help.

5. In the "Parameters" window, click the "Load to device" button.
The set parameters are loaded to the device.

6.4 Modbus address register

6.4.1 Modbus address table for single-phase devices with Modbus interface

Continuous measured values

Modbus measured variables with the function codes 03 and 04

Address		Number of registers	Format	Access	Unit	Factor	Measured variable
Hex	Decimal						
0002	2	2	UINT32	R	V	0.01	Voltage
0004	4	2	–	–	–	–	–
0006	6	2	–	–	–	–	–
0008	8	2	UINT32	R	A	0.001	Current
000A	10	2	–	–	–	–	–
000C	12	2	–	–	–	–	–
000E	14	2	–	–	–	–	–
0010	16	2	–	–	–	–	–
0012	18	2	–	–	–	–	–
0014	20	2	INT32	R	W	10.0	Active power
0016	22	2	–	–	–	–	–
0018	24	2	–	–	–	–	–
001A	26	2	INT32	R	var	10.0	Reactive power
Range limit							
0026	38	2	INT32	R	–	0.01	Power factor
Range limit							
0032	50	2	INT32	R	Hz	0.1	Frequency

Power values

Modbus measured variables with the function codes 03 and 04

Address		Number of registers	Format	Access	Unit	Factor	Measured variable
Hex	Decimal						
0812	2066	2	INT32	R	W	0.1	Average active power (15m demand)
Range limit							
0A12	2578	2	INT32	R	W	0.1	Max. average active power (max demand)

Energy counters

Modbus measured variables with the function codes 03 and 04

Address		Number of registers	Format	Access	Unit	Factor	Measured variable
Hex	Decimal						
1A20	6688	2	UINT32	R	Wh	1.0	Total active energy
1A22	6690	2	–	–	–	–	–
1A24	6692	2	UINT32	R	varh	1.0	Total reactive energy
1A26	6694	2	–	–	–	–	–
1A28	6696	2	–	–	–	–	–
1A2A	6698	2	UINT32	R	Wh	1.0	Partial active energy
1A2C	6700	2	–	–	–	–	–
1A2E	6702	2	UINT32	R	varh	1.0	Partial reactive energy

Operating hours counter

Modbus measured variables with the function codes 03 and 04

Address		Number of registers	Format	Access	Unit	Factor	Measured variable
Hex	Decimal						
1E00	7680	2	UINT32	R	s	1.0	Operating hours counter
1E02	7682	2	UINT32	R	s	1.0	Partial operating hours counter

Status

Modbus measured variables with the function codes 03 and 04

Address		Number Register	Format	Access	Unit	Factor	Measured variable
Hex	Decimal						
2210	8720	1	UINT	R	–	–	Status of the programmable threshold

6.4.2 Modbus address table for three-phase devices 5 A with Modbus interface

Continuous measured values

Modbus measured variables with the function codes 03 and 04

Address		Number of registers	Format	Access	Unit	Factor	Measured variable
Hex	Decimal						
0002	2	2	UINT32	R	V	0.01	Voltage L1N
0004	4	2	UINT32	R	V	0.01	Voltage L2N
0006	6	2	UINT32	R	V	0.01	Voltage L3N
0008	8	2	UINT32	R	A	0.0001	Current L1
000A	10	2	UINT32	R	A	0.0001	Current L2
000C	12	2	UINT32	R	A	0.0001	Current L3
000E	14	2	UINT32	R	V	0.01	Voltage L1L2
0010	16	2	UINT32	R	V	0.01	Voltage L2L3
0012	18	2	UINT32	R	V	0.01	Voltage L3L1
0014	20	2	INT32	R	W	0.01	Active power L1
0016	22	2	INT32	R	W	0.01	Active power L2
0018	24	2	INT32	R	W	0.01	Active power L3
001A	26	2	INT32	R	var	0.01	Reactive power L1
001C	28	2	INT32	R	var	0.01	Reactive power L2
001E	30	2	INT32	R	var	0.01	Reactive power L3
0020	32	2	UINT32	R	VA	0.01	Apparent power L1
0022	34	2	UINT32	R	VA	0.01	Apparent power L2
0024	36	2	UINT32	R	VA	0.01	Apparent power L3
0026	38	2	INT32	R	–	0.0001	Power factor L1
0028	40	2	INT32	R	–	0.0001	Power factor L2
002A	42	2	INT32	R	–	0.0001	Power factor L3
002C	44	2	–	R	–	–	–
002E	46	2	–	R	–	–	–
0030	48	2	–	R	–	–	–
0032	50	2	UINT32	R	Hz	0.001	Frequency
0034	52	2	UINT32	R	V	0.01	Average voltage LN
0036	54	2	UINT32	R	V	0.01	Average voltage LL
0038	56	2	UINT32	R	A	0.0001	Average current
003A	58	2	INT32	R	W	0.01	Average active power
003C	60	2	INT32	R	var	0.01	Average reactive power
003E	62	2	UINT32	R	VA	0.01	Average apparent power
0040	64	2	INT32	R	–	0.0001	Average power factor
0042	66	2	UINT32	R	%	0.01	Voltage unbalance LL
0044	68	2	UINT32	R	%	0.01	Voltage unbalance LN
0046	70	2	UINT32	R	%	0.01	Current unbalance
0048	72	2	UINT32	R	A	0.0001	Current N

Max. measured variables (HI)

Modbus measured variables with the function codes 03 and 04

Address		Number of registers	Format	Access	Unit	Factor	Measured variable
Hex	Decimal						
0400	1024	2	UINT32	R	V	0.01	Voltage L1N
...same structure as instantaneous values.							
0446	1094	2	UINT32	R	A	0.0001	Current N

Min. measured variables (LO)

Modbus measured variables with the function codes 03 and 04

Address		Number of registers	Format	Access	Unit	Factor	Measured variable
Hex	Decimal						
0600	1536	2	UINT32	R	V	0.01	Voltage L1N
...same structure as instantaneous values.							
0646	1606	2	UINT32	R	A	0.0001	Current N

Average measured variables (AV)

Modbus measured variables with the function codes 03 and 04

Address		Number of registers	Format	Access	Unit	Factor	Measured variable
Hex	Decimal						
0800	2048	2	UINT32	R	V	0.01	Voltage L1N
...same structure as instantaneous values.							
0846	2118	2	UINT32	R	A	0.0001	Current N

Max. demand values (MD)

Modbus measured variables with the function codes 03 and 04

Address		Number of registers	Format	Access	Unit	Factor	Measured variable
Hex	Decimal						
0A00	2560	2	UINT32	R	V	0.01	Voltage L1N
...same structure as instantaneous values.							
0A46	2630	2	UINT32	R	A	0.0001	Current N

Energy counters

Modbus measured variables with the function codes 03 and 04

Address		Number of registers	Format	Access	Unit	Factor	Measured variable
Hex	Decimal						
1B20	6944	4	UINT64	R	Wh	10.0	Total active energy - Import
1B24	6948	4	UINT64	R	Wh	10.0	Total active energy - Export
1B28	6952	4	UINT64	R	varh	10.0	Total reactive energy - Import
1B2C	6956	4	UINT64	R	varh	10.0	Total reactive energy - Export
1B30	6960	4	UINT64	R	VAh	10.0	Total apparent energy
1B34	6964	4	UINT64	R	Wh	10.0	Partial active energy - Import
1B38	6968	4	UINT64	R	Wh	10.0	Partial active energy - Export
1B3C	6972	4	UINT64	R	varh	10.0	Partial reactive energy - Import
1B40	6976	4	UINT64	R	varh	10.0	Partial reactive energy - Export
1B44	6980	4	UINT64	R	VAh	10.0	Partial apparent energy
1B48	6984	4	UINT64	R	Wh	10.0	T1 Active energy - Import
1B4C	6988	4	UINT64	R	Wh	10.0	T1 Active energy - Export
1B50	6992	4	UINT64	R	varh	10.0	T1 Reactive energy - Import
1B54	6996	4	UINT64	R	varh	10.0	T1 Reactive energy - Export
1B58	7000	4	UINT64	R	VAh	10.0	T1 Apparent energy
1B5C	7004	4	UINT64	R	Wh	10.0	T2 Active energy - Export
1B60	7008	4	UINT64	R	Wh	10.0	T2 Active energy - Export
1B64	7012	4	UINT64	R	varh	10.0	T2 Reactive energy - Import
1B68	7016	4	UINT64	R	varh	10.0	T2 Reactive energy - Export
1B6C	7020	4	UINT64	R	VAh	10.0	T2 Apparent energy

Address		Number of registers	Format	Access	Unit	Factor	Measured variable
Hex	Decimal						
1B98	7064	4	UINT64	R	Wh	10.0	T1 Active energy L1 - Import
1B9C	7068	4	UINT64	R	Wh	10.0	T1 Active energy L1 - Export
1BA0	7072	4	UINT64	R	varh	10.0	T1 Reactive energy L1 - Import
1BA4	7076	4	UINT64	R	varh	10.0	T1 Reactive energy L1 - Export
1BA8	7080	4	UINT64	R	VAh	10.0	T1 Apparent energy L1
1BAC	7084	4	UINT64	R	Wh	10.0	T2 Active energy L1 - Import
1BB0	7088	4	UINT64	R	Wh	10.0	T2 Active energy L1 - Export
1BB4	7092	4	UINT64	R	varh	10.0	T2 Reactive energy L1 - Import
1BB8	7096	4	UINT64	R	varh	10.0	T2 Reactive energy L1 - Export
1BBC	7100	4	UINT64	R	VAh	10.0	T2 Apparent energy L1
1BC0	7104	4	UINT64	R	Wh	10.0	T1 Active energy L2 - Import
1BC4	7108	4	UINT64	R	Wh	10.0	T1 Active energy L2 - Export
1BC8	7112	4	UINT64	R	varh	10.0	T1 Reactive energy L2 - Import
1BCC	7116	4	UINT64	R	varh	10.0	T1 Reactive energy L2 - Export
1BD0	7120	4	UINT64	R	VAh	10.0	T2 Active energy L2 - Import
1BD4	7124	4	UINT64	R	Wh	10.0	T2 Active energy L2 - Export

Address		Number of registers	Format	Access	Unit	Factor	Measured variable
Hex	Decimal						
1BD8	7128	4	UINT64	R	Wh	10.0	T2 Reactive energy L2 - Import
1BDC	7132	4	UINT64	R	varh	10.0	T2 Reactive energy L2 - Export
1BE0	7136	4	UINT64	R	varh	10.0	T2 Reactive energy L2 - Export
1BE4	7140	4	UINT64	R	VAh	10.0	T2 Apparent energy L2
1BE8	7144	4	UINT64	R	Wh	10.0	T1 Active energy L3 - Import
1BEC	7148	4	UINT64	R	Wh	10.0	T1 Active energy L3 - Export
1BF0	7152	4	UINT64	R	varh	10.0	T1 Reactive energy L3 - Import
1BF4	7156	4	UINT64	R	varh	10.0	T1 Reactive energy L3 - Export
1BF8	7160	4	UINT64	R	VAh	10.0	T1 Apparent energy L3
1BFC	7164	4	UINT64	R	Wh	10.0	T2 Active energy L3 - Import
1C00	7168	4	UINT64	R	Wh	10.0	T2 Active energy L3 - Export
1C04	7172	4	UINT64	R	varh	10.0	T2 Reactive energy L3 - Import
1C08	7176	4	UINT64	R	varh	10.0	T2 Reactive energy L3 - Export
1C0C	7180	4	UINT64	R	VAh	10.0	T2 Apparent energy L3

Address		Number of registers	Format	Access	Unit	Factor	Measured variable
Hex	Decimal						
1E20	7712	4	UINT64	R	Wh	10.0	Total active energy L1 - Import
1E24	7716	4	UINT64	R	Wh	10.0	Total active energy L1 - Export
1E28	7720	4	UINT64	R	varh	10.0	Total reactive energy L1 - Import
1E2C	7724	4	UINT64	R	varh	10.0	Total reactive energy L1 - Export
1E30	7728	4	UINT64	R	VAh	10.0	Total apparent energy L1
1E34	7732	4	UINT64	R	Wh	10.0	Partial active energy L1 - Import
1E38	7736	4	UINT64	R	Wh	10.0	Partial active energy L1 - Export
1E3C	7740	4	UINT64	R	varh	10.0	Partial reactive energy L1 - Import
1E40	7744	4	UINT64	R	varh	10.0	Partial reactive energy L1 - Import
1E44	7748	4	UINT64	R	VAh	10.0	Partial apparent energy L1
1E48	7752	4	UINT64	R	Wh	10.0	Total active energy L2 - Import
1E4C	7756	4	UINT64	R	Wh	10.0	Total active energy L2 - Export
1E50	7760	4	UINT64	R	varh	10.0	Total reactive energy L2 - Import
1E54	7764	4	UINT64	R	varh	10.0	Total reactive energy L2 - Export
1E58	7768	4	UINT64	R	VAh	10.0	Total apparent energy L2
1E5C	7772	4	UINT64	R	Wh	10.0	Partial active energy L2 - Import
1E60	7776	4	UINT64	R	Wh	10.0	Partial active energy L2 - Export
1E64	7780	4	UINT64	R	varh	10.0	Partial reactive energy L2 - Import
1E68	7784	4	UINT64	R	varh	10.0	Partial reactive energy L2 - Export
1E6C	7788	4	UINT64	R	VAh	10.0	Partial apparent energy L2
1E70	7792	4	UINT64	R	Wh	10.0	Total active energy L3 - Import
1E74	7796	4	UINT64	R	Wh	10.0	Total active energy L3 - Export
1E78	7800	4	UINT64	R	varh	10.0	Total reactive energy L3 - Import
1E7C	7804	4	UINT64	R	varh	10.0	Total reactive energy L3 - Export
1E80	7808	4	UINT64	R	VAh	10.0	Total apparent energy L3

Address		Number of registers	Format	Access	Unit	Factor	Measured variable
Hex	Decimal						
1E84	7812	4	UINT64	R	Wh	10.0	Partial active energy L3 - Import
1E88	7816	4	UINT64	R	Wh	10.0	Partial active energy L3 - Export
1E8C	7820	4	UINT64	R	varh	10.0	Partial reactive energy L3 - Import
1E90	7824	4	UINT64	R	varh	10.0	Partial reactive energy L3 - Export
1E94	7828	4	UINT64	R	VAh	10.0	Partial apparent energy L3

Hour counter

Modbus measured variables with the function codes 03 and 04

Address		Number of registers	Format	Access	Unit	Factor	Measured variable
Hex	Decimal						
1E00	7680	2	UINT32	R	s	1.0	Total operating hours counter
1E02	7682	2	UINT32	R	s	1.0	Partial operating hours counter 1
1E04	7684	2	UINT32	R	s	1.0	Partial operating hours counter 2
1E06	7686	2	UINT32	R	s	1.0	Partial operating hours counter 3
1E08	7688	2	UINT32	R	s	1.0	Partial operating hours counter 4

Status

Modbus measured variables with the function codes 03 and 04

Address		Number of registers	Format	Access	Unit	Factor	Measured variable
Hex	Decimal						
2140	8512	1	UINT16	R	BOOL	–	OR across all limits *1
2141	8513	1	UINT16	R	BOOL	–	Limit 1
2142	8514	1	UINT16	R	BOOL	–	Limit 2
2143	8515	1	UINT16	R	BOOL	–	Limit 3
2144	8516	1	UINT16	R	BOOL	–	Limit 4
2145	8517	1	UINT16	R	BOOL	–	Limit 5
2146	8518	1	UINT16	R	BOOL	–	Limit 6
2147	8519	1	UINT16	R	BOOL	–	Limit 7
2148	8520	1	UINT16	R	BOOL	–	Limit 8

¹ Example: If the value (hex) =0x05, inputs 1 and 3 are active.

Address		Number of registers	Format	Access	Unit	Factor	Measured variable
Hex	Decimal						
4F00	20224	1	UINT16	R	BOOL	–	Remote 1
4F01	20225	1	UINT16	R	BOOL	–	Remote 2
4F02	20226	1	UINT16	R	BOOL	–	Remote 3
4F04	20227	1	UINT16	R	BOOL	–	Remote 4

Modbus command parameter

Modbus measured variables with the function code 06

Address		Number of registers	Format	Access	Unit	Factor	Measured variable
Hex	Decimal						
2FF0	12272	1	UINT16	W	0	–	Reset max & min values
			UINT16	W	1	–	Reset max demand values
			UINT16	W	2	–	Reset partial energy counter
			UINT16	W	3	–	Reset partial operating hours counter
			UINT16	W	4	–	Reset external counters
			UINT16	W	5	–	Reset energy tariffs
			UINT16	W	6	–	Reset alarms
			UINT16	W	7	–	Reset limits
			UINT16	W	11	–	Reset total energy
			UINT16	W	12	–	Reset all operating hours counters
			UINT16	W	13	–	Reset parameters to factory default ¹⁾
			UINT16	W	14	–	Backup all parameters ¹⁾
			UINT16	W	15	–	Restore all parameters ¹⁾
			UINT16	W	16	–	Wiring test ²⁾
			UINT16	W	100	–	Reset maximum values
UINT16	W	200	–	Reset minimum values			
2FF1	12273	1	UINT16	W	1	–	System restart
Range limit							
4200	16896	1	UINT16	W	1, 2	–	Set active energy tariff ³⁾

1) After executing this command, it is recommended that you issue the REBOOT command.

2) After executing this command, you can use the query under address 0x1F20 to obtain the test result. The assignments of the reply bit are shown in the wiring test results table below.

3) This function is only active if none of the inputs is assigned the tariff function (TAR-A and TAR-B).

Wiring test results

Address		Number of registers	Format	Access	Active bit	Measured variable
Hex	Decimal					
1F20	7968	2	UINT32	R	0	Voltage L1N
			UINT32	R	1	Voltage L2N
			UINT32	R	2	Voltage L3N
			UINT32	R	3	Current L1
			UINT32	R	4	Current L2
			UINT32	R	5	Current L3
			UINT32	R	6	Incorrect phase sequence
			UINT32	R	7	Phase unbalance
			UINT32	R	8	Current transformer L1 inverted
			UINT32	R	9	Current transformer L2 inverted
			UINT32	R	10	Current transformer L3 inverted
			UINT32	R	11	Current transformers L1 to L2
			UINT32	R	12	Current transformers L1 to L3
			UINT32	R	13	Current transformers L2 to L1
			UINT32	R	14	Current transformers L2 to L3
			UINT32	R	15	Current transformers L3 to L1
UINT32	R	16	Current transformers L3 to L2			

The wiring is correct if the result is 0 or no bit is active.

Parameter setup

Parameters are read and changed in accordance with the following rules:

Address		Number of registers	Format	Access	Unit	Factor	Measured variable
Hex	Decimal						
5000	20480	1	UINT16	RW	–	–	Menu Number selection ¹⁾
5001	20481	1	UINT16	RW	–	–	Menu Number selection ¹⁾
5002	20482	1	UINT16	RW	–	–	Parameter Number selection ¹⁾
5004	20484	1 ... 28	UINT16	RW	–	–	Parameter value ²⁾
2F01	12033	1	UINT16	RW	–	0.1	Write to Flash memory ¹⁾

¹⁾ Accessed via the function codes 0x04 (read) or 0x06 (write).

²⁾ Accessed via 0x04 (read), 0x06 (write), or 0x16 (multiwrite).

6.4.3 Modbus address table for three-phase devices 80 A with Modbus interface

Continuous measured values

Modbus measured variables with the function codes 03 and 04

Address		Number of registers	Format	Access	Unit	Factor	Measured variable
Hex	Decimal						
0002	2	2	UINT32	R	V	0.01	Voltage L1N
0004	4	2	UINT32	R	V	0.01	Voltage L2N
0006	6	2	UINT32	R	V	0.01	Voltage L3N
0008	8	2	UINT32	R	A	0.0001	Current L1
000A	10	2	UINT32	R	A	0.0001	Current L2
000C	12	2	UINT32	R	A	0.0001	Current L3
000E	14	2	UINT32	R	V	0.01	Voltage L1L2
0010	16	2	UINT32	R	V	0.01	Voltage L2L3
0012	18	2	UINT32	R	V	0.01	Voltage L3L1
0014	20	2	INT32	R	W	0.01	Active power L1
0016	22	2	INT32	R	W	0.01	Active power L2
0018	24	2	INT32	R	W	0.01	Active power L3
001A	26	2	INT32	R	var	0.01	Reactive power L1
001C	28	2	INT32	R	var	0.01	Reactive power L2
001E	30	2	INT32	R	var	0.01	Reactive power L3
0020	32	2	UINT32	R	VA	0.01	Apparent power L1
0022	34	2	UINT32	R	VA	0.01	Apparent power L2
0024	36	2	UINT32	R	VA	0.01	Apparent power L3
0026	38	2	INT32	R	–	0.0001	Power factor L1
0028	40	2	INT32	R	–	0.0001	Power factor L2
002A	42	2	INT32	R	–	0.0001	Power factor L3
002C	44	2	–	–	–	–	–
002E	46	2	–	–	–	–	–
0030	48	2	–	–	–	–	–
0032	50	2	UINT32	R	Hz	0.01	Frequency
0034	52	2	UINT32	R	V	0.01	Average Voltage LN
0036	54	2	UINT32	R	V	0.01	Average Voltage LL
0038	56	2	–	–	–	–	–
003A	58	2	INT32	R	W	0.01	Average Active power
003C	60	2	INT32	R	var	0.01	Average Reactive power
003E	62	2	UINT32	R	VA	0.01	Average Apparent power
0040	64	2	INT32	R	–	0.0001	Average Power factor

Energy counters

Modbus measured variables with the function codes 03 and 04

Address		Number of registers	Format	Access	Unit	Factor	Measured variable
Hex	Decimal						
1A20	6688	2	UINT32	R	Wh	1.0	Active energy - Import
1A22	6690	2	UINT32	R	Wh	1.0	Active energy - Export
1A24	6692	2	UINT32	R	varh	1.0	Reactive energy - Import
1A26	6694	2	UINT32	R	varh	1.0	Reactive energy - Export
1A28	6696	2	–	–	–	–	–
1A2A	6698	2	UINT32	R	Wh	1.0	Partial active energy - Import
1A2C	6700	2	UINT32	R	Wh	1.0	Partial active energy - Export
1A2E	6702	2	UINT32	R	varh	1.0	Partial reactive energy - Import
1A30	6704	2	UINT32	R	varh	1.0	Partial reactive energy - Export
1A32	6706	2	–	–	–	–	–
1A34	6708	2	UINT32	R	Wh	1.0	L1 Active energy - Import
1A36	6710	2	UINT32	R	Wh	1.0	L1 Active energy - Export
1A38	6712	2	UINT32	R	varh	1.0	L1 Reactive energy - Import
1A3A	6714	2	UINT32	R	varh	1.0	L1 Reactive energy - Export
1A3C	6716	2	–	–	–	–	–
1A3E	6718	2	UINT32	R	Wh	1.0	Partial L1 active energy - Import
1A40	6720	2	UINT32	R	Wh	1.0	Partial L1 active energy - Export
1A42	6722	2	UINT32	R	varh	1.0	Partial L1 reactive energy - Import
1A44	6724	2	UINT32	R	varh	1.0	Partial L1 reactive energy - Export
1A46	6726	2	–	–	–	–	–
1A48	6728	2	UINT32	R	Wh	1.0	L2 Active energy - Import
1A4A	6730	2	UINT32	R	Wh	1.0	L2 Active energy - Export
1A4C	6732	2	UINT32	R	varh	1.0	L2 Reactive energy - Import
1A4E	6734	2	UINT32	R	varh	1.0	L2 Reactive energy - Export
1A50	6736	2	–	–	–	–	–
1A52	6738	2	UINT32	R	Wh	1.0	Partial L2 active energy - Import
1A54	6740	2	UINT32	R	Wh	1.0	Partial L2 active energy - Export
1A56	6742	2	UINT32	R	varh	1.0	Partial L2 reactive energy - Export
1A58	6744	2	UINT32	R	varh	1.0	Partial L2 reactive energy - Export
1A5A	6746	2	–	–	–	–	–
1A5C	6748	2	UINT32	R	Wh	1.0	L3 Active energy - Import
1A5E	6750	2	UINT32	R	Wh	1.0	L3 Active energy - Export
1A60	6752	2	UINT32	R	varh	1.0	L3 Reactive energy - Import
1A62	6754	2	UINT32	R	varh	1.0	L3 Reactive energy - Export
1A64	6756	2	–	–	–	–	–
1A66	6758	2	UINT32	R	Wh	1.0	Partial L3 active energy - Export
1A68	6760	2	UINT32	R	Wh	1.0	Partial L3 active energy - Export
1A6A	6762	2	UINT32	R	varh	1.0	Partial L3 reactive energy - Import
1A6C	6764	2	UINT32	R	varh	1.0	Partial L3 reactive energy - Export
1A6E	6766	2	–	–	–	–	–

Tariff energy counters

Modbus measured variables with the function codes 03 and 04

Address		Number of registers	Format	Access	Unit	Factor	Measured variable
Hex	Decimal						
1B48	6984	2	UINT32	R	Wh	1.0	T1 Active energy - Import
1B4A	6986	2	–	–	–	–	–
1B4C	6988	2	UINT32	R	Wh	1.0	T1 Active energy - Export
1B4E	6990	2	–	–	–	–	–
1B50	6992	2	UINT32	R	varh	1.0	T1 Reactive energy - Import
1B52	6994	2	–	–	–	–	–
1B54	6996	2	UINT32	R	varh	1.0	T1 Reactive energy - Export
1B56	6998	2	–	–	–	–	–
1B58	7000	2	–	–	–	–	–
1B5A	7002	2	–	–	–	–	–
1B5C	7004	2	UINT32	R	Wh	1.0	T2 Active energy - Import
1B5E	7006	2	–	–	–	–	–
1B60	7008	2	UINT32	R	Wh	1.0	T2 Active energy - Export
1B62	7010	2	–	–	–	–	–
1B64	7012	2	UINT32	R	varh	1.0	T2 Reactive energy - Import
1B66	7014	2	–	–	–	–	–
1B68	7016	2	UINT32	R	varh	1.0	T2 Reactive energy - Export
1B6A	7018	2	–	–	–	–	–
1B6C	7020	2	–	–	–	–	–
1B6E	7022	2	–	–	–	–	–
1B70	7024	2	–	–	–	–	–
1B72	7026	2	–	–	–	–	–
1B74	7028	2	–	–	–	–	–
1B76	7030	2	–	–	–	–	–
1B78	7032	2	–	–	–	–	–
1B7A	7034	2	–	–	–	–	–
1B7C	7036	2	–	–	–	–	–
1B7E	7038	2	–	–	–	–	–
1B80	7040	2	–	–	–	–	–
1B82	7042	2	–	–	–	–	–
1B84	7044	2	–	–	–	–	–
1B86	7046	2	–	–	–	–	–
1B88	7048	2	–	–	–	–	–
1B8A	7050	2	–	–	–	–	–
1B8C	7052	2	–	–	–	–	–
1B8E	7054	2	–	–	–	–	–
1B90	7056	2	–	–	–	–	–
1B92	7058	2	–	–	–	–	–
1B94	7060	2	–	–	–	–	–
1B96	7062	2	–	–	–	–	–
1B98	7064	2	UINT32	R	Wh	1.0	T1 Active energy L1 - Import

Address		Number of registers	Format	Access	Unit	Factor	Measured variable
Hex	Decimal						
1B9A	7066	2	–	–	–	–	–
1B9C	7068	2	UINT32	R	Wh	1.0	T1 Active energy L1 - Export
1B9E	7070	2	–	–	–	–	–
1BA0	7072	2	UINT32	R	varh	1.0	T1 Reactive energy L1 - Import
1BA2	7074	2	–	–	–	–	–
1BA4	7076	2	UINT32	R	varh	1.0	T1 Reactive energy L1 - Export
1BA6	7078	2	–	–	–	–	–
1BA8	7080	2	–	–	–	–	–
1BAA	7082	2	–	–	–	–	–
1BAC	7084	2	UINT32	R	Wh	1.0	T2 Active energy L1 - Import
1BAE	7086	2	–	–	–	–	–
1BB0	7088	2	UINT32	R	Wh	1.0	T2 Active energy L1 - Export
1BB2	7090	2	–	–	–	–	–
1BB4	7092	2	UINT32	R	varh	1.0	T2 Reactive energy L1 - Import
1BB6	7094	2	–	–	–	–	–
1BB8	7096	2	UINT32	R	varh	1.0	T2 Reactive energy L1 - Export
1BBA	7098	2	–	–	–	–	–
1BBC	7100	2	–	–	–	–	–
1BBE	7102	2	–	–	–	–	–
1BC0	7104	2	UINT32	R	Wh	1.0	T1 Active energy L2 - Import
1BC2	7106	2	–	–	–	–	–
1BC4	7108	2	UINT32	R	Wh	1.0	T1 Active energy L2 - Export
1BC6	7110	2	–	–	–	–	–
1BC8	7112	2	UINT32	R	varh	1.0	T1 Reactive energy L2 - Import
1BCA	7114	2	–	–	–	–	–
1BCC	7116	2	UINT32	R	varh	1.0	T1 Reactive energy L2 - Export
1BCE	7118	2	–	–	–	–	–
1BD0	7120	2	–	–	–	–	–
1BD2	7122	2	–	–	–	–	–
1BD4	7124	2	UINT32	R	Wh	1.0	T2 Active energy L2 - Import
1BD6	7126	2	–	–	–	–	–
1BD8	7128	2	UINT32	R	Wh	1.0	T2 Active energy L2 - Export
1BDA	7130	2	–	–	–	–	–
1BDC	7132	2	UINT32	R	varh	1.0	T2 Reactive energy L2 - Import
1BDE	7134	2	–	–	–	–	–
1BE0	7136	2	UINT32	R	varh	1.0	T2 Reactive energy L2 - Export
1BE2	7138	2	–	–	–	–	–
1BE4	7140	2	–	–	–	–	–
1BE6	7142	2	–	–	–	–	–
1BE8	7144	2	UINT32	R	Wh	1.0	T1 Active energy L3 - Import
1BEA	7146	2	–	–	–	–	–
1BEC	7148	2	UINT32	R	Wh	1.0	T1 Active energy L3 - Export
1BEE	7150	2	–	–	–	–	–
1BF0	7152	2	UINT32	R	varh	1.0	T1 Reactive energy L3 - Import

Address		Number of registers	Format	Access	Unit	Factor	Measured variable
Hex	Decimal						
1BF2	7154	2	–	–	–	–	–
1BF4	7156	2	UINT32	R	varh	1.0	T1 Reactive energy L3 - Export
1BF6	7158	2	–	–	–	–	–
1BF8	7160	2	–	–	–	–	–
1BFA	7162	2	–	–	–	–	–
1BFC	7164	2	UINT32	R	Wh	1.0	T2 Active energy L3 - Import
1BFE	7166	2	–	–	–	–	–
1C00	7168	2	UINT32	R	Wh	1.0	T2 Active energy L3 - Export
1C02	7170	2	–	–	–	–	–
1C04	7172	2	UINT32	R	varh	1.0	T2 Reactive energy L3 - Import
1C06	7174	2	–	–	–	–	–
1C08	7176	2	UINT32	R	varh	1.0	T2 Reactive energy L3 - Export
1C0A	7178	2	–	–	–	–	–

Hour counter

Modbus measured variables with the function codes 03 and 04

Address		Number of registers	Format	Access	Unit	Factor	Measured variable
Hex	Decimal						
1E00	7680	2	UINT32	R	s	1.0	Partial operating hours counter 1
1E02	7682	2	UINT32	R	s	1.0	Partial operating hours counter 2
1E04	7684	2	UINT32	R	s	1.0	Partial operating hours counter 3

Parameter setup

Note

Write commands are only possible with the 7KT1665 80 A, Modbus RTU (not MID)

Parameters are read and changed in accordance with the following rules:

Address		Number of registers	Format	Access	Unit	Factor	Measured variable
Hex	Decimal						
5000	20480	1	UINT16	RW	–	–	Menu Number selection ¹⁾
5002	20482	1	UINT16	RW	–	–	Parameter Number selection ¹⁾
5004	20484	1 ... 28	UINT16	RW	–	–	Parameter value ²⁾
2F01	12033	1	UINT16	W	–	0.1	Write to Flash memory ¹⁾

¹ Accessed via the function codes 0x04 (read) or 0x06 (write).

² Accessed via 0x04 (read), 0x06 (write), or 0x16 (multiwrite).

Service and maintenance

The device has been calibrated by the manufacturer before shipping. Recalibration is not required provided the environmental conditions are maintained.

7.1 Firmware update

A firmware update is not possible.

7.2 Lost or forgotten password

If you lose or forget the password, a 6-digit unlock code appears on the display after three consecutive incorrect attempts. You can obtain more information on this as well as the activation code from Siemens Support (<http://www.siemens.com/lowvoltage/support-request/>).

After you have entered the activation code, you can change the setting in the usual manner (parameter P.01). You can find more information in chapter Command menu (Page 64).

7.3 Fault elimination measures

Fault	Measures
Device is not working.	<ul style="list-style-type: none"> • Check power supply connection. • Check fuse.
Voltage or current measured values are not displayed.	<ul style="list-style-type: none"> • Check fuse. • Check configuration. You can find more information under Parameterizing with powerconfig (Page 80).
Voltage values are not plausible.	If current transformer is present, check the settings and the connection of the current transformer and correct.
Current values are not plausible.	Check the settings and the wiring of the current transformer (if present) and correct if necessary.
No communication	Check communication settings.
Power values are incorrect, although voltage and current are correctly applied.	<ul style="list-style-type: none"> • Check voltages and currents of the phases to ensure that they are properly connected to one another. • Check the polarity of the current transformers, if present.

7.4 Warranty

Note

Loss of warranty

If you open the device, you will invalidate the Siemens warranty. Only the manufacturer is permitted to carry out repairs to the devices. Return faulty or damaged devices to Siemens for repair or replacement.

Procedure

If the device is faulty or damaged, proceed as follows (only during the warranty period):

1. Uninstall the device. You can find more information in chapter Installing/removing three-phase device (Page 70).
2. Pack the device in a suitable manner to prevent it from being damaged during transport.
3. Return the device to Siemens. You can obtain the address from:
 - Your Siemens sales partner
 - Technical Assistance

You can find more information in chapter Latest information (Page 7).

7.5 Disposal



- Dispose of the module in accordance with the applicable laws and regulations in your country.
- Do not dispose of this device with general domestic waste.
- Collect and dispose of old devices separately.

Technical data

8.1 Technical data

PAC1600

	Current input (A)	Modbus RTU	M-Bus	S0 / Digital output	MID	Tariff input	Accuracy ¹	Weight (g)
Single-phase devices								
7KT1651	63	●	–	–	–	–	Class 1	148
7KT1652	63	●	–	–	●	–	Class B	148
7KT1653	63	–	●	–	–	–	Class 1	148
7KT1654	63	–	●	–	●	–	Class B	148
7KT1655	63	–	–	●	–	–	Class 1	148
7KT1656	63	–	–	●	●	–	Class B	148
Three-phase devices								
7KT1661	5	●	–	–	–	●	Class 0.5s	332
7KT1662	5	●	–	–	●	●	Class B	332
7KT1663	5	–	●	–	–	●	Class 0.5s	332
7KT1664	5	–	●	–	●	●	Class B	332
7KT1665	80	●	–	–	–	●	Class 0.5s	360
7KT1666	80	●	–	–	●	●	Class B	360
7KT1667	80	–	●	–	–	●	Class 1	360
7KT1668	80	–	●	–	●	●	Class B	360
7KT1670	8	–	–	2	–	●	Class 1	360
7KT1671	80	–	–	2	●	●	Class B	271
7KT1672	5	–	–	2	–	●	Class 1	332
7KT1673	5	–	–	2	●	●	Class B	332

¹ Accuracy active energy: (Versions without MID approval IEC/EN 62053-21/22. Versions with MID: EN 50470-3)

Input voltage	
Nominal voltage of single-phase devices	230 V~
Nominal voltage of three-phase devices	230 V~/ 400 V~ L-L
Operating voltage range of single-phase devices	187 ... 264 V~ L-N
Operating voltage range of three-phase devices	187 ... 264 V~ L-N 323 ... 456 V~ L-L
Nominal frequency of MID devices	50 Hz
Nominal frequency of non-MID devices	50/60 Hz
Operating frequency range	45 ... 66 Hz

Input current	
Minimum current (I_{min})	<ul style="list-style-type: none"> • At 63/80 A: 0.5 A • At 5 A: 0.05 A
Max. current (I_{max}) of 63 A devices	63 A
Max. current (I_{max}) of 80 A devices	80 A
Max. current (I_{max}) of 5 A devices	6 A
Starting current (actual) of 63 and 80 A devices	40 mA
Starting current (actual) of 5 A devices	10 mA
Burden per phase with 5 A devices	≤ 0.3 W

LED pulses	
Devices with 63 and 80 A	1000 pulses/kWh
Devices with 5 A input	10000 pulses/kWh
Length	30 ms

Environmental conditions	
Installation	For indoor use only
Operating temperature	-25 ... +55 °C
Storage temperature	-25 ... +70 °C
Relative humidity (IEC EN 60068-2-78)	< 80% non-condensing
Maximum degree of pollution	2
Overvoltage category	III
Altitude	≤ 2000 m
Climatic sequence	Z/ABDM (IEC/EN 60068-2-61)
Shock resistance	10 g (IEC/EN 60068-2-27)
Vibration resistance	0.7 g (IEC/EN 60068-2-6)
Mechanical environment	Class M1
Electromagnetic environment	Class E2

Insulation voltage	
Rated insulation voltage L-N	250 V~
Rated impulse withstand voltage U_{imp}	6 kV
AC withstand voltage	4 kV

Enclosure	
Single-phase devices	2 U (DIN 43880)
Three-phase devices	4 U (DIN 43880)
Installation	35 mm DIN rail (EN 60715) or screwed in place using extractable clips
Material	Polyamide RAL 7035
Degree of protection	Front IP40 Terminals IP20
Certification	EAC, CE

Devices with tariff input	
Nominal voltage U_{nom}	100 ... 240 V~
Operating voltage range	85 ... 264 V~
Nominal frequency	50/60 Hz
Operating frequency range	45 ... 66 Hz
Current consumption, power loss of 80 A devices	0.9 VA, 0.6 W
Current consumption, power loss of 5 A devices	0.25 VA, 0.18 W

Devices with S0 interface or digital output	
Number of pulses programmable in single-phase devices	<ul style="list-style-type: none"> • 1 pulse/kWh • 10 pulses/kWh • 100 pulses/kWh
Number of pulses programmable in three-phase devices 80 A	<ul style="list-style-type: none"> • 1 pulse/kWh • 10 pulses/kWh • 100 pulses/kWh • 1000 pulses/kWh
Number of pulses programmable in three-phase devices 5 A	<ul style="list-style-type: none"> • 0.1 pulses/kWh • 1 pulse/kWh • 10 pulses/kWh • 100 pulses/kWh
Pulse length	<ul style="list-style-type: none"> • 60 ms for 1000 pulses/kWh • 100 ms for all other values
External voltage	10 V DC ... 30 V DC
Maximum current	50 mA

Devices with RS 485 interface	
Speed programmable in 63 A and 80 A devices	1200 ... 38400 bps
Speed programmable in 5 A devices	1200 ... 115200 bps

Devices with M-Bus (slave)	
Bus length	In accordance with M-Bus specification
Speed	Programmable 300 ... 38400 baud
Typical current consumption	≤ 3 mA (2 charging units)

Certifications

The SENTRON PAC1600 complies with the requirements of the following European Directives:



- DIRECTIVE 2014/30/EU OF THE EUROPEAN PARLIAMENT AND COUNCIL of February 26, 2014, on the harmonization of the laws of the Member States relating to electromagnetic compatibility and repealing the Directive 89/336/EEC
- DIRECTIVE 2014/35/EU OF THE EUROPEAN PARLIAMENT AND COUNCIL of February 26, 2014, on the harmonization of the laws of the Member States relating to electrical equipment designed for use within certain voltage limits
- DIRECTIVE 2011/65/EU OF THE EUROPEAN PARLIAMENT AND COUNCIL OF June 8, 2011 on the restriction of the use of certain hazardous substances in electrical and electronic devices

Conformity with these Directives is verified by compliance with the following standards:

- EN 61010-1: 2011
- EN 61010-2-030: 2011
- EN 61326-1: 2013
- EN 50581: 2012
- CLC/TR 50579

Approval for Eurasian customs union



Valid in Russia, Belarus, Kazakhstan, Kyrgyzstan and Armenia.

MID conformity (option)







Devices on the market with MID marking conform with Directive 2014/32/EU OF THE EUROPEAN PARLIAMENT AND COUNCIL of February 26, 2014, on the harmonization of the laws of the Member States relating to the provision of measuring instruments.

Verification

Conformity with these Directives is verified by compliance with the following standards:

- EN 50470-1: 2006
- EN 50570-3: 2006

8.2 Labels on the enclosure

Symbol, label	Explanation
PAC1600	Product/device designation
LOB/YYMMDDxxxxxx	Serial number of the device
	EAC certification
CAT III	Overvoltage category CAT III for current and voltage inputs
	Protective insulation, device with safety class II
	CE mark. Confirmation of conformity of the product with the applicable EU directives and compliance with the essential requirements contained in these directives
	Electrical installation demands technical competence.
	Metrology mark. Confirmation of conformity of the product with Measurement Instruments Directive 2014/32/EU and compliance with the essential requirements contained therein. M: MID mark (Measurement Instruments Directive) M20: Year 2020 - year of calibration in production 0051: Identification number of the notified body IMQ 327: Number of the certificate
	Do not dispose of this device with general domestic waste.

Dimensional drawings

9.1 Single-phase device

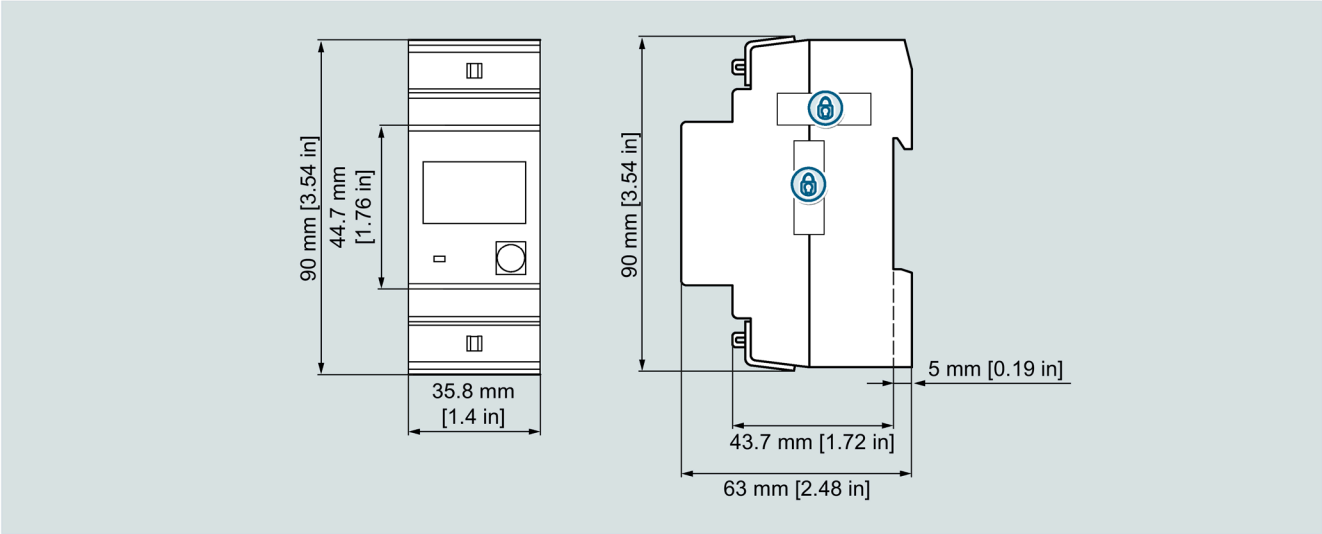

9.2 Three-phase device

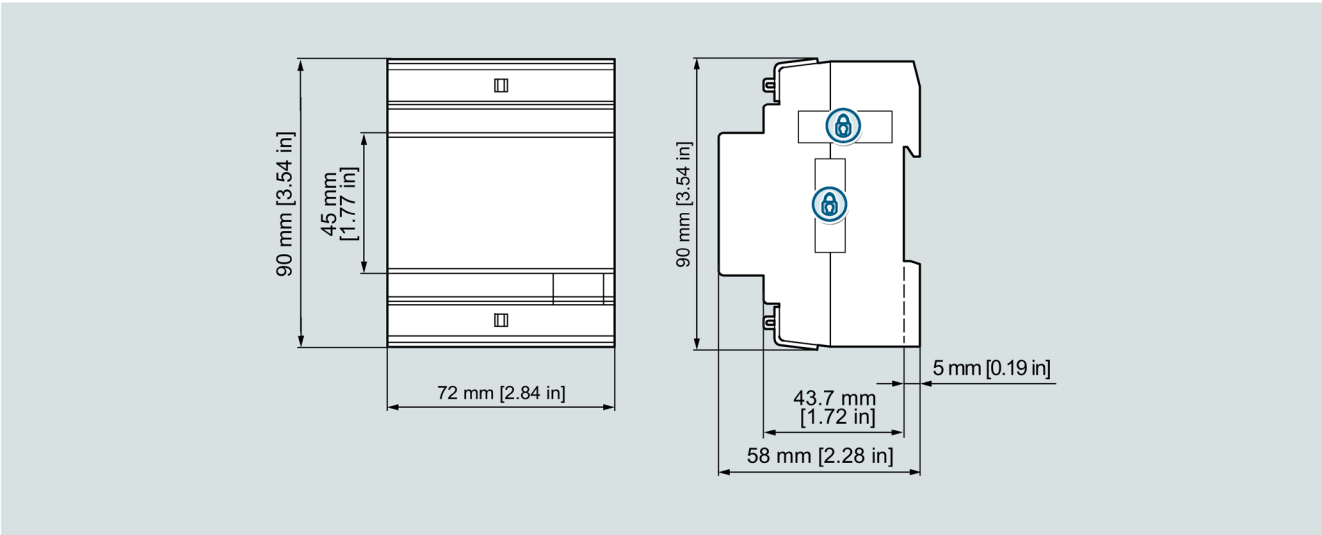

ESD guidelines

A.1 Electrostatic sensitive devices (ESD)

Electrostatic sensitive devices are destroyed by voltage and energy levels far below the limits of human perception. Voltages of this kind occur as soon as a device or an assembly is touched by a person who is not electrostatically discharged. Electrostatic sensitive devices which have been subject to such voltages are usually not immediately recognized as being defective, because a malfunction does not occur until after an extended period of operation.

ESD Guidelines

<p>NOTICE</p> <p>Electrostatic sensitive devices</p> <p>Electronic modules contain components that can be destroyed by electrostatic discharge. These modules can be easily destroyed or damaged by improper handling.</p> <ul style="list-style-type: none"> • You must discharge your body electrostatically immediately before touching an electronic module. To do this, touch a conductive, grounded object, e.g., a bare metal part of a switch cabinet or the water pipe. • Always hold the component by the plastic enclosure. • Electronic modules should not be brought into contact with electrically insulating materials such as plastic film, plastic parts, insulating table supports or clothing made of synthetic fibers. • Always place electrostatic sensitive devices on conductive bases. • Always store and transport electronic modules or components in ESD-safe conductive packaging, e.g. metallized plastic or metal containers. Leave the component in its packaging until installation.
<p>NOTICE</p> <p>Storage and transport</p> <p>If you have to store or transport the module in non-conductive packaging, you must pack the module in ESD-safe, conductive material, e.g. conductive foam rubber, ESD bag.</p>

ESD workstation

The diagrams below illustrate the required ESD protective measures for electrostatic sensitive devices.

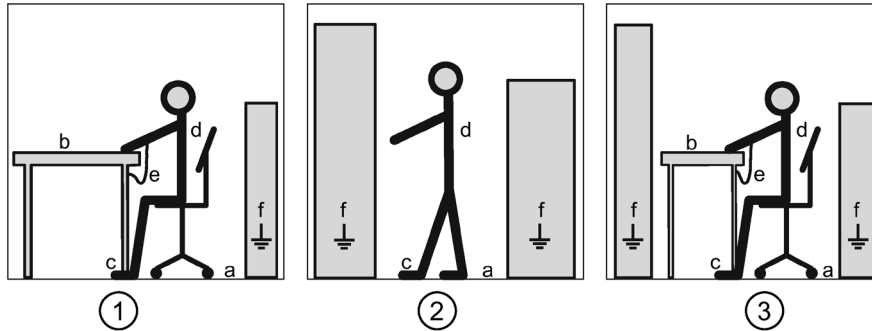

- ① ESD seat
- ② ESD standing position
- ③ ESD seat and ESD standing position

Protective measures

- a Conductive floor
- b ESD table
- c ESD footwear
- d ESD smock
- e ESD bracelet
- f Cubicle ground connection

Index

C

- CE conformity, 102
- Classroom
 - Training, 7
- Commissioning
 - Measuring voltage, 80
 - Prerequisites, 79
- Components of the product
 - Available accessories, 7
- Connection
 - Single-phase device, 74
 - Three-phase device, 76

D

- Device version
 - Single-phase device, 19
 - Three-phase device with 5 A, 42
 - Three-phase device with 80 A, 29
- Device versions, 15
- Disposal, 98

E

- ESD guidelines, 107

I

- Installation
 - Three-phase device, 70
- Installation location
 - Environmental conditions, 69
- Interfaces, 16

K

- Keypad function
 - Single-phase device, 19
 - Three-phase 80 A device, 29, 43

L

- Latest information, 7

M

- Main entry
 - Access main menu, 44
 - Increase and Decrease keys, 44
 - Next key, 44
- Measured values
 - Single-phase device, 21
 - Three-phase device, 31
- Measuring inputs
 - Current measurement, 17
 - Voltage measurement, 18
- MID conformity, 102
- MID-approved, 17
- Modbus address table
 - Single-phase devices, (Continuous measured values), (Power values), (Energy counters), (Hour counter), (Status)
 - Three-phase 5 A devices, (Continuous measured values), (Max. measured variables (HI)), (Min. measured variables (LO)), (Average measured variables (AV)), (Max. demand values (MD)), (Energy counters), (Hour counter), (Status), (Modbus command parameter), (Wiring test results), (Parameter setup)
 - Three-phase 80 A devices, (Continuous measured values), (Energy counters), (Tariff energy counters), (Hour counter), (Parameter setup)

O

- Open Source Software, 8

P

- Parameter tables
 - P01 General, 54
 - P02 Other, 54
 - P03 Password, 56
 - P04 Integration, 56
 - P05 Hour counter, 57
 - P07 Communication M-Bus, 58
 - P07 Communication Modbus, 58
 - P08 Limit thresholds, 59
 - P09 Alarms, 60

Parameterization
 Device menu, three-phase device, 30
 Parameter table, single-phase device, 24
 Parameter table, three-phase device, 33
 powerconfig, 80
powerconfig
 Functions, 67

Q

Qualified personnel, 9

R

Removal
 Three-phase device, 70

S

Safety instructions, 11
Safety-related symbols, 12
Single-phase devices
 Navigation with front key, 19

T

Technical data
 Accuracy, 99
 Current input, 99
 Digital input, 99
 Enclosure, 101
 Environmental conditions, 100
 Input current, 100
 Input voltage, 99
 Insulation voltage, 100
 LED pulses, 100
 M-Bus, 102
 RS 485 interface, 101
 S0 interface, 101
 Tariff input, 101
 Weight, 99
Three-phase 80 A devices
 Increase and Decrease keys, 29
 Next key, 29
Training, 7, 7
 Learning paths, 7
 WBT, 7

W

Warranty
 Procedure, 98
WBT
 Training, 7
WBT – web-based training, 7

Further Information

Always at your disposal: our extensive support
www.siemens.com/online-support

Siemens AG
Smart Infrastructure
Electrical Products
Postfach 10 09 53
93009 REGENSBURG
Germany

Subject to change.

SI EP
Online

