



Dimension

| | | | | | |
|-------|---|------|---|----------|------|
| L | * | W | * | H | |
| 325.8 | * | 107 | * | 41 (1U) | mm |
| 12.8 | * | 4.21 | * | 1.61(1U) | inch |



Front



Back



Features

- Universal AC input / Full range
- Built-in active PFC function
- High efficiency up to 94.5%
- Forced air cooling by built-in DC fan
- Output voltage and constant current level programmable
- Active current sharing up to 16000W (4+1)
- Protections: Short circuit / Overload / Over voltage / Over temperature
- Optional conformal coating
- Optional PMBus or CANBus protocol
- 5 years warranty

Applications

- Factory control or automation apparatus
- Test and measurement instrument
- Laser related machine
- Aging facility
- Digital broadcasting
- Constant current source
- Redundant system

GTIN CODE

MW Search: <https://www.meanwell.com/serviceGTIN.aspx>

Description

DPU-3200 is a 3.2KW single output enclosed type AC/DC power supply with 1U low profile and a high power density up to 37W/inch³. This series operates for 90~264VAC input voltage and offers the models with the DC output mostly demanded by the industry. Each model is cooled by the thermostatically controlled fan. Moreover, DPU-3200 provides vast design flexibility by equipping various built-in functions such as output programming, active current sharing, remote ON-OFF control, auxiliary power, and etc.

Model Encoding / Order Information

DPU - 3200 - 24 □

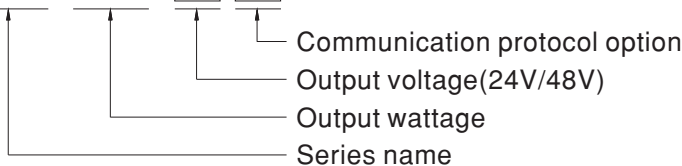

| Type | Communication Protocol | Note |
|-------|------------------------|------------|
| Blank | None | In Stock |
| PM | PMBus protocol | By request |
| CAN | CANBus protocol | By request |

SPECIFICATION

| MODEL | | DPU-3200-24 | DPU-3200-48 | |
|---------------------------------------|--|---|---|--------------------------|
| OUTPUT | DC VOLTAGE | 24V | 48V | |
| | RATED CURRENT | 133A | 67A | |
| | CURRENT RANGE | 0 ~ 133A | 0 ~ 67A | |
| | RATED POWER | 3192W | 3216W | |
| | RIPPLE & NOISE (max.) <small>Note.2,3</small> | 300mVp-p | 480mVp-p | |
| | VOLTAGE ADJ. RANGE | 23.5 ~ 30V | 47.5 ~ 58.8V | |
| | VOLTAGE TOLERANCE <small>Note.4</small> | ± 1.0% | ± 1.0% | |
| | LINE REGULATION | ± 0.5% | ± 0.5% | |
| | LOAD REGULATION | ± 0.5% | ± 0.5% | |
| | SETUP, RISE TIME | 1500ms, 60ms/230VAC at full load | | |
| HOLD UP TIME (Typ.) | 16ms / 230VAC at 75% load 9ms / 230VAC at full load | | | |
| INPUT | VOLTAGE RANGE <small>Note.5</small> | 90 ~ 264VAC 127 ~ 370VDC | | |
| | FREQUENCY RANGE | 47 ~ 63Hz | | |
| | POWER FACTOR (Typ.) | 0.97/230VAC at full load | | |
| | EFFICIENCY (Typ.) <small>Note.6</small> | 93.5% | 94.5% | |
| | AC CURRENT (Typ.) <small>Note.5</small> | 17A/230VAC | | |
| | INRUSH CURRENT (Typ.) | COLD START 55A/230VAC | | |
| | LEAKAGE CURRENT | <2mA / 230VAC | | |
| PROTECTION | OVERLOAD | 105 ~ 115% rated current Protection type : Constant current limiting, shut down O/P voltage after 5 sec. After O/P voltage falls, re-power on to recover | | |
| | OVER VOLTAGE | 31.5 ~ 37.5V | 63 ~ 75V | |
| | OVER TEMPERATURE | Shut down o/p voltage, recovers automatically after temperature goes down | | |
| FUNCTION | OUTPUT VOLTAGE PROGRAMMABLE(PV) | Adjustment of output voltage is allowable to 50 ~ 125% of nominal output voltage Please refer to the Function Manual in following pages | | |
| | CONSTANT CURRENT LEVEL PROGRAMMABLE(PC) | Adjustment of constant current level is allowable to 20 ~ 100% of rated current. Please refer to the Function Manual in following pages | | |
| | REMOTE ON-OFF CONTROL | By electrical signal or dry contact Power ON:short Power OFF:open. Please refer to the Function Manual in following pages | | |
| | REMOTE SENSE | Compensate voltage drop on the load wiring up to 0.5V. Please refer to the Function Manual in following pages | | |
| | AUXILIARY POWER | 5V @ 0.3A, tolerance ± 10%, ripple 150mVp-p, 12V @ 0.8A, tolerance ± 10%, ripple 450mVp-p | | |
| ALARM SIGNAL | Isolated TTL signal output for T-Alarm and DC-OK. Please refer to the Function Manual in following pages | | | |
| ENVIRONMENT | WORKING TEMP. | -30 ~ +70°C (Refer to "Derating Curve") | | |
| | WORKING HUMIDITY | 20 ~ 90% RH non-condensing | | |
| | STORAGE TEMP., HUMIDITY | -40 ~ +85°C, 10 ~ 95% RH non-condensing | | |
| | TEMP. COEFFICIENT | ± 0.03%/°C (0 ~ 50°C) | | |
| | VIBRATION | 10 ~ 500Hz, 2G 10min./1cycle, 60min. each along X, Y, Z axes | | |
| SAFETY & EMC <small>(Note 10)</small> | SAFETY STANDARDS | UL62368-1, CSA C22.2 No. 62368-1, TUV BS EN/EN62368-1, EAC TP TC 004 approved | | |
| | WITHSTAND VOLTAGE | I/P-O/P:3KVAC I/P-FG:2KVAC O/P-FG:1.5KVAC | | |
| | ISOLATION RESISTANCE | I/P-O/P, I/P-FG, O/P-FG:100M Ohms / 500VDC / 25°C / 70% RH | | |
| | EMC EMISSION | Parameter | Standard | Test Level / Note |
| | | Conducted | BS EN/EN55032 (CISPR32) | Class B |
| | | Radiated | BS EN/EN55032 (CISPR32) | Class A |
| | | Harmonic Current | BS EN/EN61000-3-2 | Class A |
| | Voltage Flicker | BS EN/EN61000-3-3 | ---- | |
| | EMC IMMUNITY | BS EN/EN55035, BS EN/EN61000-6-2 | | |
| | | Parameter | Standard | Test Level / Note |
| ESD | | BS EN/EN61000-4-2 | Level 3, 8KV air ; Level 2, 4KV contact | |
| Radiated | | BS EN/EN61000-4-3 | Level 3 | |
| EFT / Burst | | BS EN/EN61000-4-4 | Level 3 | |
| Surge | | BS EN/EN61000-4-5 | 2KV/Line-Line 4KV/Line-Earth | |
| Conducted | | BS EN/EN61000-4-6 | Level 3 | |
| Magnetic Field | | BS EN/EN61000-4-8 | Level 4 | |
| Voltage Dips and Interruptions | BS EN/EN61000-4-11 | >95% dip 0.5 periods, 30% dip 25 periods, >95% interruptions 250 periods | | |
| OTHERS | MTBF | 502.9K hrs min. Telcordia SR-332 (Bellcore) ; 44.9K hrs min. MIL-HDBK-217F (25°C) | | |
| | DIMENSION | 325.8*107*41mm (L*W*H) | | |
| | PACKING | 2.76Kg;4pcs/12Kg/0.81CUFT | | |
| NOTE | <ol style="list-style-type: none"> All parameters NOT specially mentioned are measured at 230VAC input, rated load and 25°C of ambient temperature. Ripple & noise are measured at 20MHz of bandwidth by using a 12" twisted pair-wire terminated with a 0.1uf & 47uf parallel capacitor. Under variable load application or parallel operation ripple of the output voltage may be higher than the SPEC at light load condition. It will go back to normal ripple level once the output load is more than 5%. Tolerance : includes set up tolerance, line regulation and load regulation. Derating may be needed under low input voltages. Please check the derating curve for more details. The efficiency is measured at 75% load. If use PV signal to adjust Vo, under certain operating conditions, ripple noise of Vo might slightly go over rating defined in this specification. Output will shut down after O/P voltage is below < 80% of Vset for 5 sec, re-power on to recover. When 2 or more PSUs are in parallel connection, long cable(s) used for parallel connection might generate higher noise to communication signal. Thus, we suggest using proper filtering part(s) to avoid interference on communication . The power supply is considered a component which will be installed into a final equipment. All the EMC tests are been executed by mounting the unit on a 600mm*900mm metal plate with 1mm of thickness. The final equipment must be re-confirmed that it still meets EMC directives. For guidance on how to perform these EMC tests, please refer to "EMI testing of component power supplies." (as available on http://www.meanwell.com) The ambient temperature derating of 3.5°C/1000m with fanless models and of 5°C/1000m with fan models for operating altitude higher than 2000m(6500ft). <p>※ Product Liability Disclaimer : For detailed information, please refer to https://www.meanwell.com/serviceDisclaimer.aspx</p> | | | |

BLOCK DIAGRAM

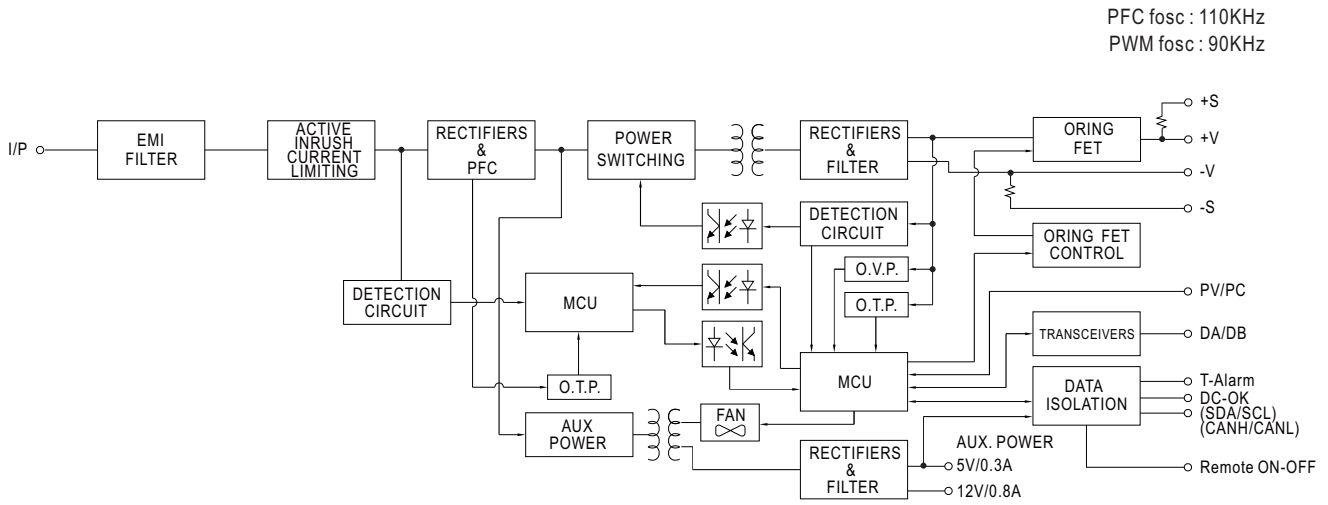

STATIC CHARACTERISTICS

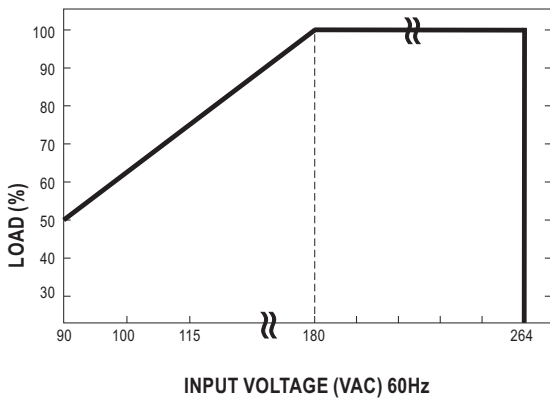

DERATING LOADs vs INPUT VOLTAGE

| INPUT | MODEL | |
|------------|-------|-------|
| | 24V | 48V |
| 180~264VAC | 3192W | 3216W |
| | 133A | 67A |
| 90VAC | 1596W | 1608W |
| | 66.5A | 33.5A |

DERATING CURVE

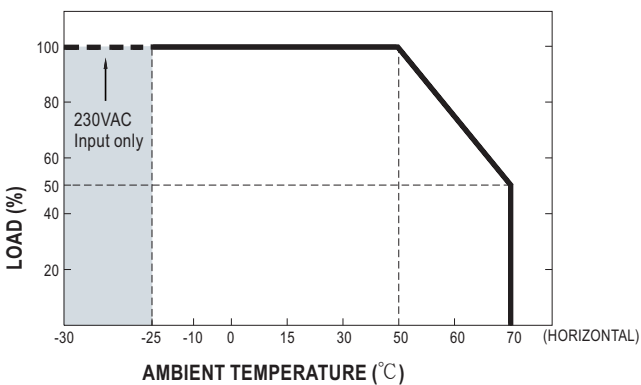

EFFICIENCY vs LOAD (48V MODEL)

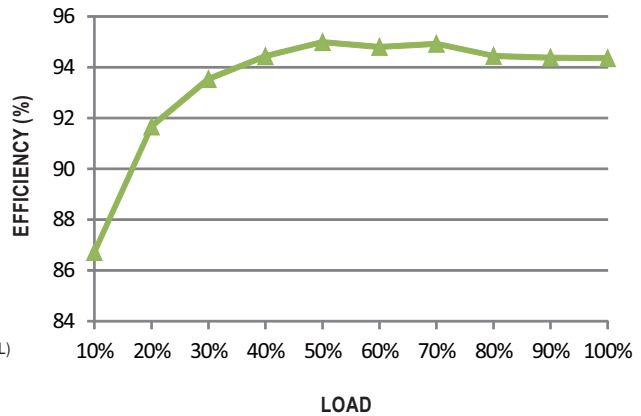

⊙ The curve above is measured at 230VAC.

FUNCTION MANUAL

1. Voltage Drop Compensation

1.1 Remote Sense

※ The Remote Sense compensates voltage drop on the load wiring up to 0.5V

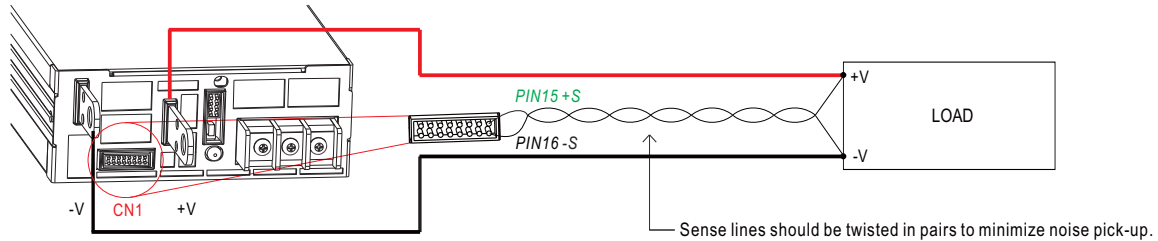

◎ The +S signal should be connected to the positive terminal of the load whereas -S signal to the negative terminal.

1.2 Local Sense

※ The +S,-S have to be connected to the +V(signal), -V(signal), respectively, as the following diagram, in order to get the correct output voltage if Remote Sense is not used.

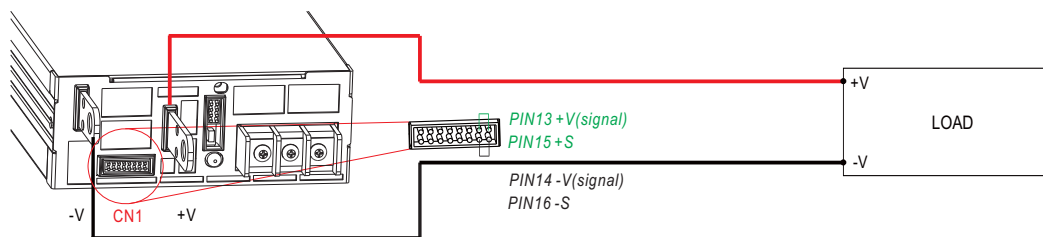

2. Output Voltage Programming (or, PV / remote voltage programming / remote adjust / margin programming / dynamic voltage trim)

※ In addition to the adjustment via the built-in potentiometer, the output voltage can be trimmed to 50~125% of the nominal voltage by applying EXTERNAL VOLTAGE.

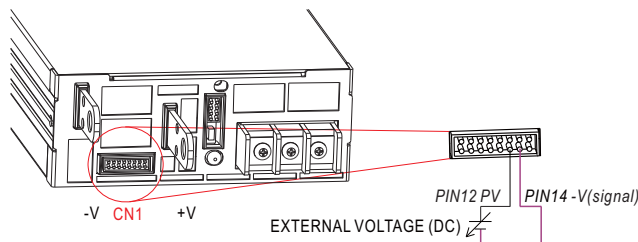

◎ For Remote Sense / Local Sense, please refer to "Voltage Drop Compensation" section.

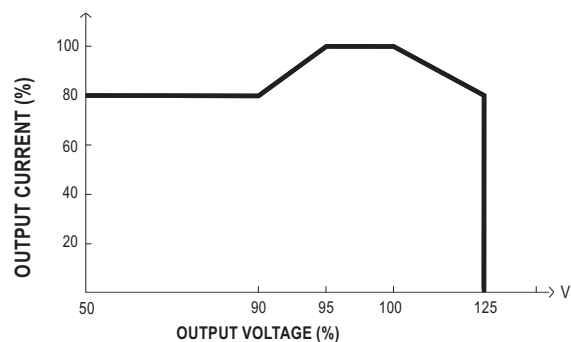
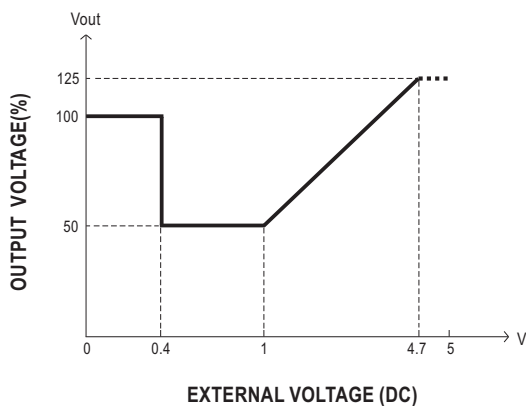

◎ The rated current should change with the Output Voltage Programming accordingly.

◎ For Remote Sense / Local Sense, please refer to "Voltage Drop Compensation" section.

3. Constant Current Level Programming (or, PC / remote current programming / dynamic current trim)

※ The constant current level can be trimmed to 20~100% of the rated current by applying EXTERNAL VOLTAGE.

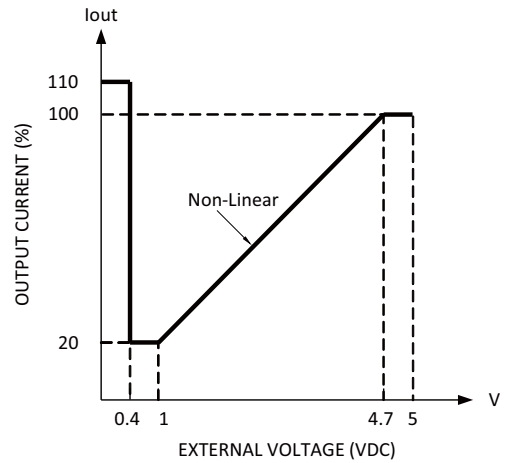
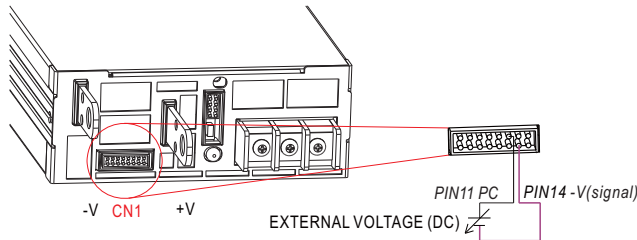

- ◎ For Remote Sense / Local Sense, please refer to "Voltage Drop Compensation" section.
- ◎ Output will shut down after O/P voltage is below < 80% of Vset for 5 sec, re-power on to recover.

※ If setting output current to a much lower level, as output status turns to constant current mode, it might cause higher current ripple under such condition.

4. Remote ON-OFF Control

※ The power supply can be turned ON/OFF individually or along with other units by using the "Remote ON-OFF" function.

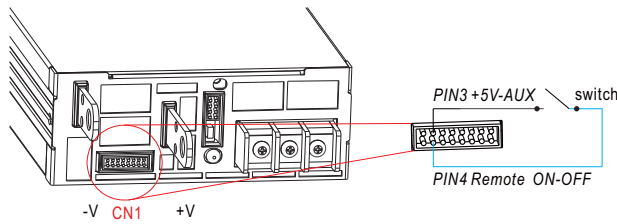

| Between Remote ON-OFF and +5V-AUX | Power Supply Status |
|-----------------------------------|---------------------|
| Switch Short | ON |
| Switch Open | OFF |

5. Alarm Signal Output

※ There are 2 alarm signals, DC OK and T-ALARM, in TTL signal form, on CN1. These signals are isolated from output. The maximum sink current is 10mA.

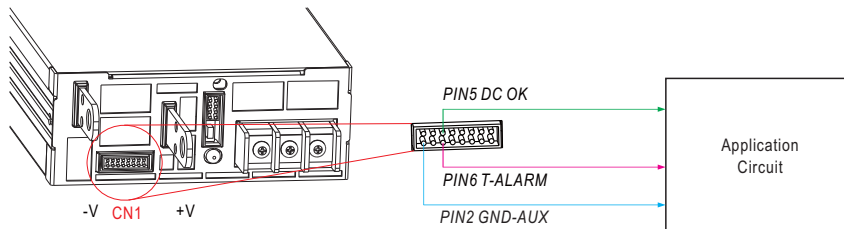

6. Current Sharing with Remote Sense

DPU-3200 has the built-in active current sharing function and can be connected in parallel, up to 5 units, to provide higher output power as exhibited below :

- ※ The power supplies should be paralleled using short and large diameter wiring and then connected to the load.
- ※ Difference of output voltages among parallel units should be less than 0.2V.
- ※ The total output current must not exceed the value determined by the following equation:

$$\text{Maximum output current at parallel operation} = (\text{Rated current per unit}) \times (\text{Number of unit}) \times 0.9$$
- ※ When the total output current is less than 5% of the total rated current, or say $(5\% \text{ of Rated current per unit}) \times (\text{Number of unit})$ the current shared among units may not be balanced.
- ※ Under parallel operation ripple of the output voltage may be higher than the SPEC at light load condition. It will go back to normal ripple level once the output load is more than 5%.
- ※ CN500/SW1 Function pin connection

| Parallel | PSU1 | | PSU2 | | PSU3 | | PSU4 | | PSU5 | |
|----------|-------|-----|-------|-----|-------|-----|-------|-----|-------|-----|
| | CN500 | SW1 | CN500 | SW1 | CN500 | SW1 | CN500 | SW1 | CN500 | SW1 |
| 1 unit | X | ON | — | — | — | — | — | — | — | — |
| 2 unit | V | ON | V | ON | — | — | — | — | — | — |
| 3 unit | V | ON | V | OFF | V | ON | — | — | — | — |
| 4 unit | V | ON | V | OFF | V | OFF | V | ON | — | — |
| 5 unit | V | ON | V | OFF | V | OFF | V | OFF | V | ON |

(V : CN500 connected ; X : CN500 not connected.)

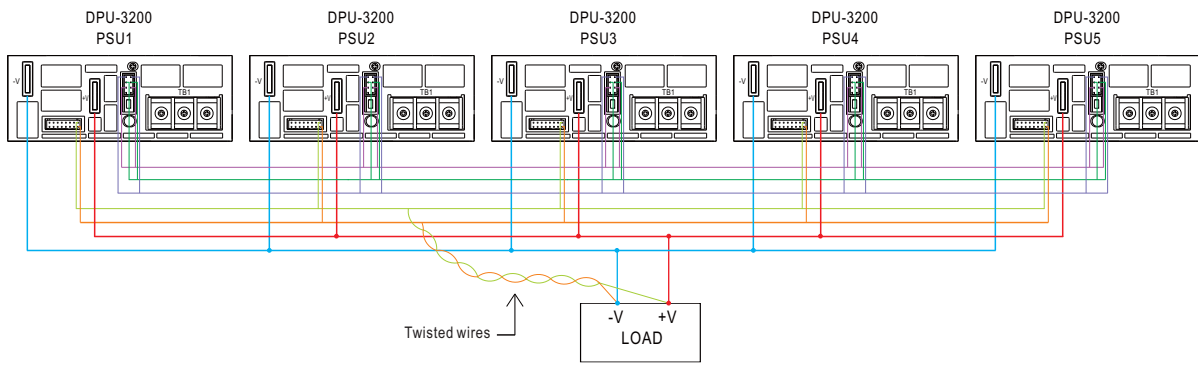
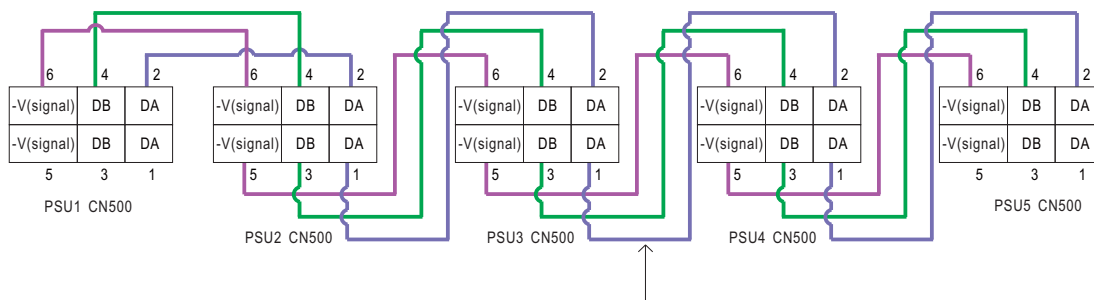

Fig 5.1



If the lines of CN500 are too long, they should be twisted in pairs to avoid the noise.

- ◎ DA, DB and -V(signal) are connected mutually in parallel.
- ◎ For Remote Sense / Local Sense, please refer to "Voltage Drop Compensation" section.

MECHANICAL SPECIFICATION

Case No.256 Unit:mm

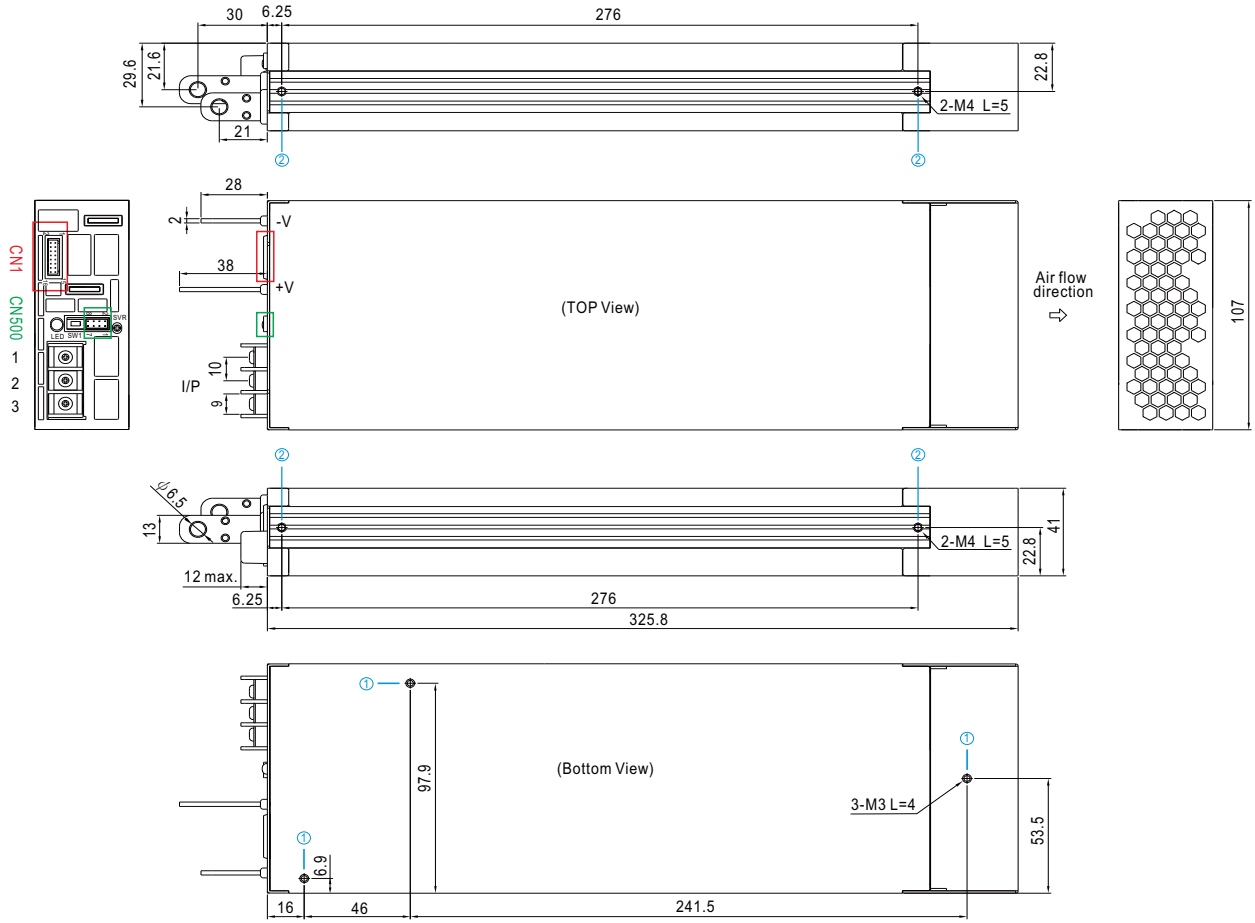

※ Mounting Instruction

| Hole No. | Recommended Screw Size | MAX. Penetration Depth L | Recommended mounting torque |
|----------|------------------------|--------------------------|-----------------------------|
| ① | M3 | 4mm | 6~8Kgf-cm |
| ② | M4 | 5mm | 7~10Kgf-cm |

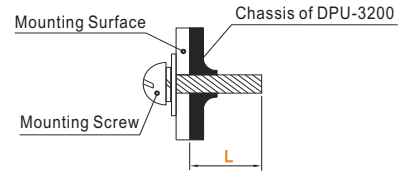

※ Control Pin No. Assignment(CN1) : HRS DF11-16DP-2DS or equivalent

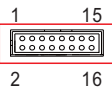



| | |
|----------------|-----------------------------|
| Mating Housing | HRS DF11-16DS or equivalent |
| Terminal | HRS DF11-**SC or equivalent |

| Pin No. | Function | Description |
|---------|---------------|--|
| 1 | +12V-AUX | Auxiliary voltage output, 10.6~13.2V, referenced to GND-AUX (pin2). The maximum load current is 0.8A. This output has the built-in "Oring diodes" and is not controlled by "Remote ON-OFF". |
| 2 | GND-AUX | Auxiliary voltage output GND. The signal return is isolated from the output terminals (+V & -V). |
| 3 | +5V-AUX | Auxiliary voltage output, 4.5~5.5V, referenced to GND-AUX (pin2). The maximum load current is 0.3A. This output has the built-in "Oring diodes" and is not controlled by "Remote ON-OFF". |
| 4 | Remote ON-OFF | The unit can turn the output ON/OFF by electrical signal or dry contact between <i>Remote ON/OFF</i> and +5V-AUX. (Note.2) Short (4.5 ~ 5.5V) : Power ON ; Open (-0.5 ~ 0.5V) : Power OFF ; The maximum input voltage is 5.5V. |
| 5 | DC-OK | High (3.5 ~ 5.5V) : When the $V_{out} \leq 77\% \pm 5\%$. Low (-0.5 ~ 0.5V) : When $V_{out} \geq 80\% \pm 5\%$. The maximum sourcing current is 10mA and only for output. (Note.2) |
| 6 | T-ALARM | High (3.5 ~ 5.5V) : When the internal temperature exceeds the limit of temperature alarm, or when Fan fails. Low (-0.5 ~ 0.5V) : When the internal temperature is normal, and when Fan works normally. The maximum sourcing current is 10mA and only for output.(Note.2) |
| 7,8,9 | NC | For standard model: Retain for future use. |
| | A0,A1,A2 | For PMBus / CANBus model: PMBus / CANBus interface address lines. (Note.1) |
| 10 | NC | Retain for future use. |
| 11 | PC | Connection for constant current level programming. (Note.1) |
| 12 | PV | Connection for output voltage programming. (Note.1) |
| 13 | +V (Signal) | Positive output voltage signal. It is for local sense; it cannot be connected directly to the load. |
| 14 | -V (Signal) | Negative output voltage signal. It is for local sense and certain function reference; it cannot be connected directly to the load. |
| 15 | +S | Positive sensing for remote sense. |
| 16 | -S | Negative sensing for remote sense. |

Note1: Non-isolated signal, referenced to [-V(signal)].
Note2: Isolated signal, referenced to GND-AUX.

※ LED Status Indicators

| LED | Description |
|--|---|
|  Green | The power supply functions normally. |
|  Red | The LED will present a constant red light when the abnormal status (OTP, OLP, fan fail and charging timeout) arises. |
|  Red (Flashing) | The LED will flash with the red light when the internal temperature reaches 60°C; under this condition, the unit still operates normally without entering OTP. (In the meantime, an alarm signal will be sent out through the PMBus interface.) |

※ AC Input Terminal Pin No. Assignment

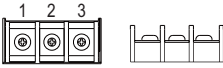
| Pin No. | Assignment | Diagram | Maximum mounting torque |
|---------|------------|---|-------------------------|
| 1 | FG \perp |  | 8Kgf-cm |
| 2 | AC/N | | |
| 3 | AC/L | | |

※ Control Pin No. Assignment(CN500) : HRS DF11-8DP-2DS or equivalent

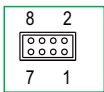

| | |
|----------------|-----------------------------|
| Mating Housing | HRS DF11-8DS or equivalent |
| Terminal | HRS DF11-**SC or equivalent |

| Pin No. | Function | Description |
|---------|-------------|---|
| 1, 2 | DA | Differential digital signal for parallel control. |
| 3, 4 | DB | Differential digital signal for parallel control. |
| 5, 6 | -V (Signal) | Negative output voltage signal. It is for local sense and certain function reference; it cannot be connected directly to the load. |
| 7 | NC | For standard model: None. |
| | SDA | For PMBus model: Serial Data used in the PMBus interface. (Note) |
| | CANH | For CANBus model: Data line used in CANBus interface. (Note) |
| 8 | NC | For standard model: None. |
| | SCL | For PMBus model: Serial Clock used in the PMBus interface. (Note) |
| | CANL | For CANBus model: Data line used in CANBus interface. (Note) |

Note: Isolated signal, referenced to GND-AUX.

※ Control Pin No. Assignment.(SW1)

| Pin No. | Function | Description |
|---------|---------------------|--|
| 1, 2 | Terminal resistance | SW1 is the selector of terminal resistor that is designed for DA/DB signals and parallel control function. |

■ INSTALLATION MANUAL

Please refer to : <http://www.meanwell.com/manual.html>