

EVOLV X



Thank you
for choosing

PHANTEKS

■ 1. What's inside?

Introduction	3
Specifications	4
Exploded view	5
Accessories	6

■ 2. Choose your setup

Configure your Evolv X	7
Get started	8
Installing motherboard	10
Installing power supply	11
Installing fans	12
<i>Connecting the Fan Hub</i>	
Installing drives	14
Installing water cooling	17
<i>Radiator installation</i>	
<i>Pump/Reservoir installation</i>	
Installing GPU Anti-Sag Bracket	20

Connecting front I/O	21
D-RGB lighting	22
<i>Sync lighting with D-RGB motherboard</i>	
Cable Management	24
Optional Upgrades:	25
Installing vertical GPU	27
Installing Dual System	28

■ 3. Support

Contact us	30
Warranty	31

INTRODUCTION

Welcome to Phanteks!

The Evolv X is one of the most versatile mid-tower chassis out there, ready for the future and the most powerful hardware.

Built from premium materials that are engineered with utmost care and attention to detail. A design based on continuous product improvement and innovation throughout the Evolv Series. Discover the ultimate building experience.

Phanteks believes that meaningful designs are created through the fusion of form and function.

The Phanteks team

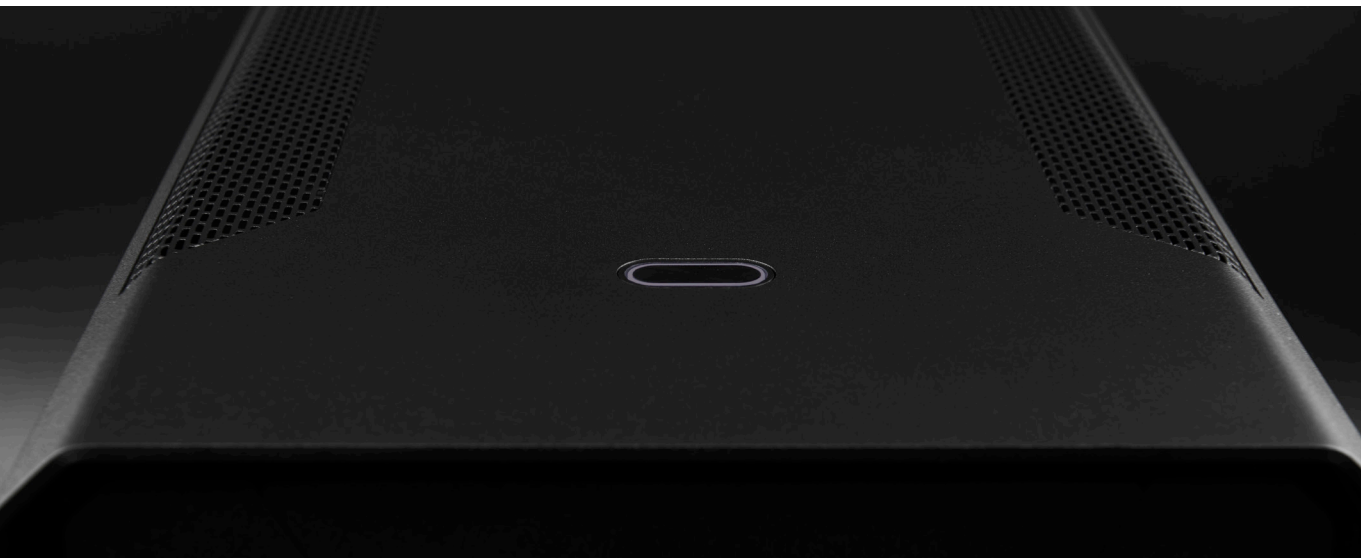

SPECIFICATIONS

CASE SPECIFICATIONS

Dimension (WxHxD)	240 mm x 520 mm x 510 mm 94.5 in x 20.5 in x 20.1 in
Form Factor	Mid Tower
Materials	Anodized aluminum panels Powder coated steel chassis Tempered glass side panels
MB Support	E-ATX, ATX, Micro-ATX, Mini ITX
Front I/O	Power button, 2x USB 3.0, Microphone, Headphone, D-RGB Mode button, D-RGB Color button, USB 3.1 GEN 2 Type-C
Side Window	Yes, Tempered glass both sides

PCI SLOTS & DRIVE BAYS

PCI slots	7x
Internal 3.5"	10x (4 included)
Internal 2.5"	9x (6 included)

FAN	120 mm	140 mm
Front	3x	3x (2 installed)
Top	3x	2x
Rear	1x	1x (1 installed)

RADIATOR	120 mm	140 mm
Front	Up to 360	Up to 420
Top	Up to 360	Up to 280
Rear	120	140

INCLUDED ACCESSORIES

Premium fan 140 mm	3x (installed)
Universal Fan Hub	1x (installed)
3.5" stackable HDD bracket	4x
Vertical GPU Mount	1x
Accessory bag	1x
Anti-Sag Bracket	1x
Airflow Cover	1x
Toolbox	1x

CLEARANCE

CPU Cooler Clearance	190 mm (7.48 in)
GPU Clearance	435 mm (17.24 in)
Front Radiator thickness	95 mm (3.74 in)
Top Radiator thickness	65 mm (2.56 in)

SUPPORT

Contact (International)	support@phanteks.com
Contact (North and South America)	support@phanteksusa.com
Warranty	5 Years*

*see page 31

EXPLODED VIEW

1. Chassis
2. Front Panel
3. Top Panel
4. Side Panels
5. Radiator Bracket
6. PSU Bracket
7. Dual System Cover
8. SSD Covers
9. Airflow Cover
10. Front Dust Filter
11. PSU Filter

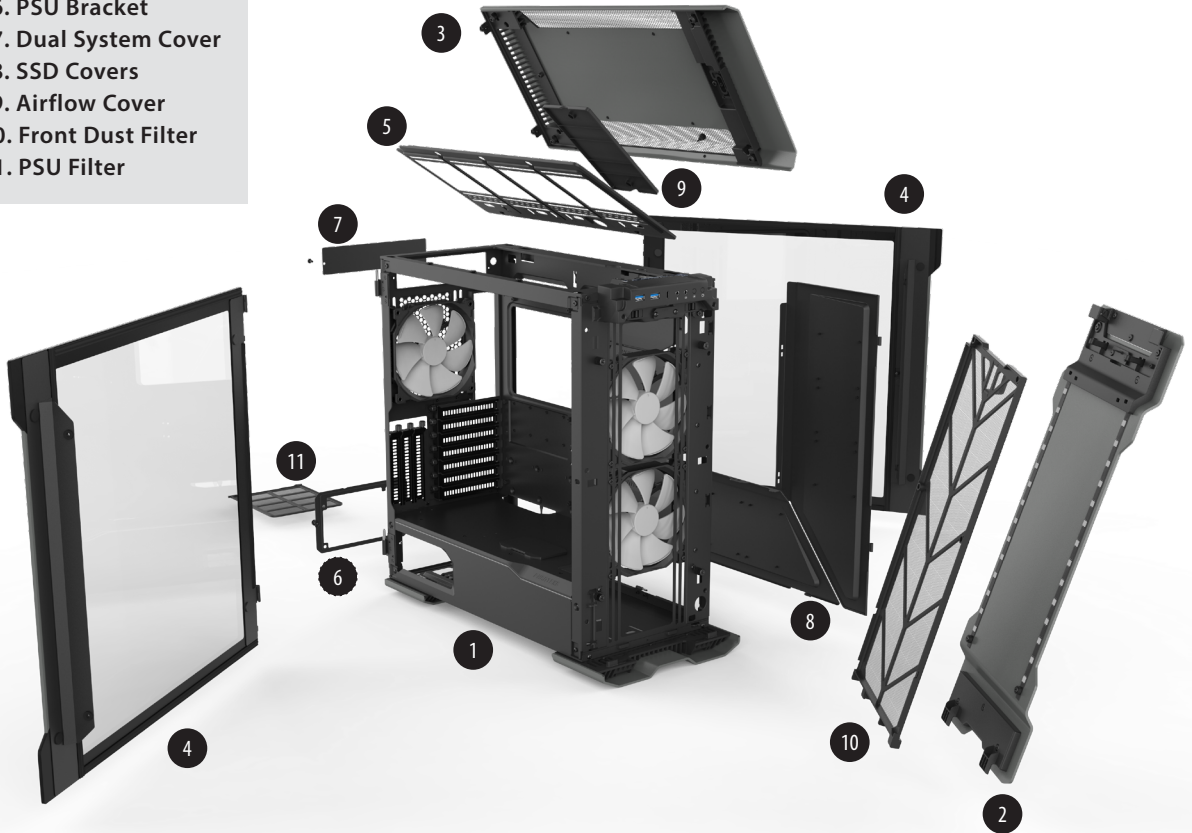

ACCESSORIES

3.5" MODULAR HDD BRACKET

- 4 included in accessory box
- For 3.5" or 2.5" Drive



PREMIUM FAN 140 MM

- 3 Pre-installed
- High static pressure
- Silent operation



VERTICAL GPU MOUNT

- Included in accessory box
- Riser Cable is sold separately



AIRFLOW COVER

- Included in accessory box
- Magnetic

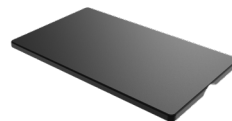

ACCESSORY BAG AND TOOLBOX

Accessory bag









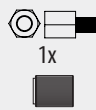

GPU Anti-Sag Bracket

6x Zip Tie 150mm

Phanteks Logo Badge

Toolbox

	M3x5 mm Motherboard / SSD / ODD screw	Fan screw	Motherboard Standoff + tool	
				
	34x	12x	1x	
6-32x6 mm Hex screw	6-32x6 mm Thumb screw	6-32x5 mm Case screw	6-32x9 mm HDD screw	Riser Cable screw
				
7x	12x	6x	16x	3x

CONFIGURE YOUR EVOLV X

The EVOLV X has the most versatile chassis design. With so many possibilities you can use this overview to choose and plan the best configuration for your build.

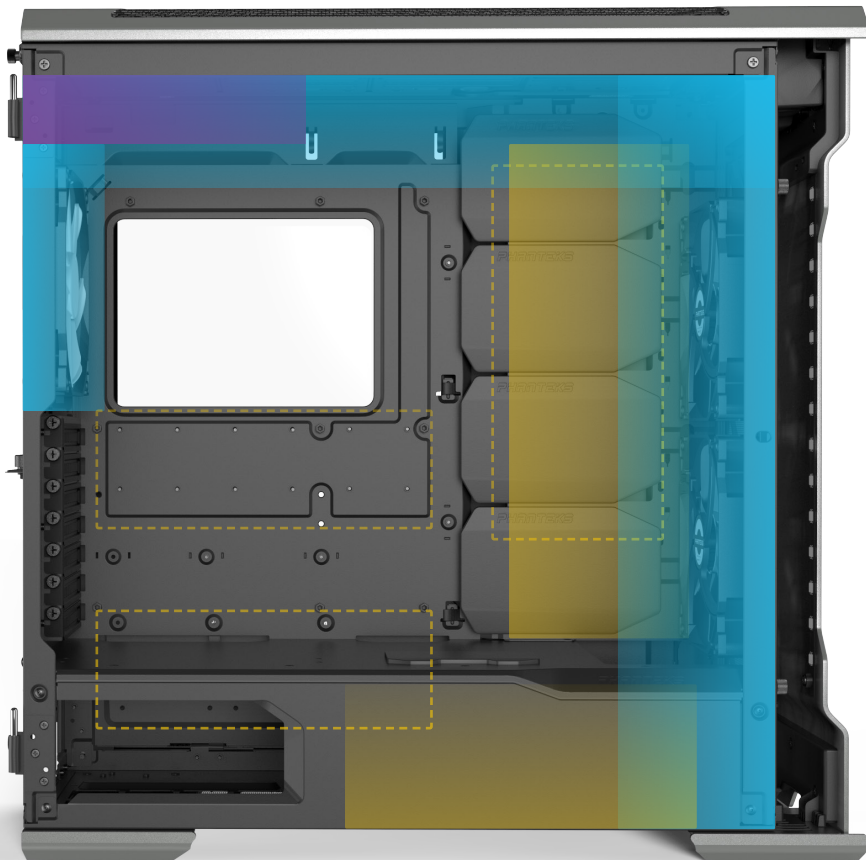

COOLING

PAGE 12

**WATER
COOLING**

PAGE 17

STORAGE

PAGE 14

**DUAL
SYSTEM**

PAGE 28

GET STARTED

PREPARATIONS

- The Evolv X case is designed to support installation in standing position.
- Don't turn on the power to your system until installation is complete.
- Discharge your body's static electric charge by touching a grounded surface before performing any hardware procedure.
- Make sure to consult the manuals of your hardware before installation.

 *If you do not feel comfortable with performing the installation procedure, consult a qualified computer technician.*

1. REMOVING FRONT PANEL



2. UNLOCKING SIDE PANELS



REMOVE:

4 x



3. OPENING SIDE PANELS



REQUIRE:



4. REMOVING TOP PANEL



PRO TIP

Use the 4x thumb screws on the front to secure the Side Panels during transport or public events.

LOOSEN:

2 x



INSTALLING MOTHERBOARD

Use the motherboards screws from the toolbox to install your motherboard on the pre-installed standoffs.

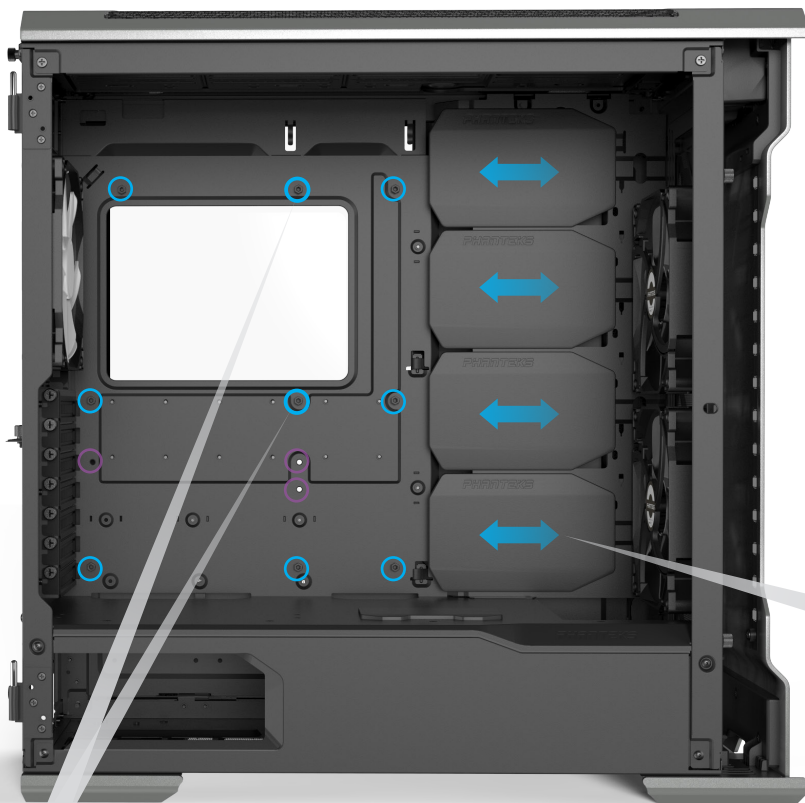

PRO TIP

These standoffs have a special collar to keep the motherboard in place when installing vertically.



REQUIRE:



For repositioning standoffs



STANDOFF POSITIONING

ATX / E-ATX
(Pre-installed)



Micro ATX
install extra standoffs



 Some motherboards require installation / repositioning of the standoffs. Please consult your motherboard manual for the correct standoff positioning.



PRO TIP

By loosening the thumb screws you can slide the Cable Covers left and right for optimal cable management.

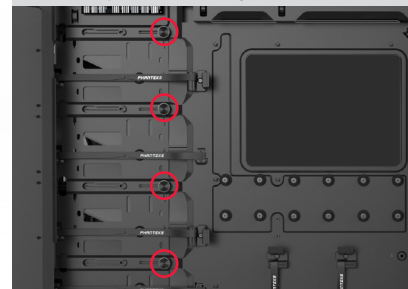

INSTALLING POWER SUPPLY

The power supply can be installed by removing the PSU bracket on the rear.

REQUIRE:

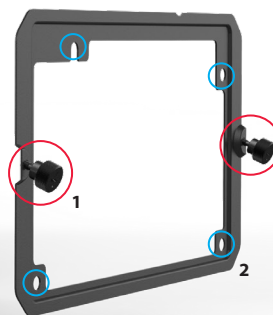
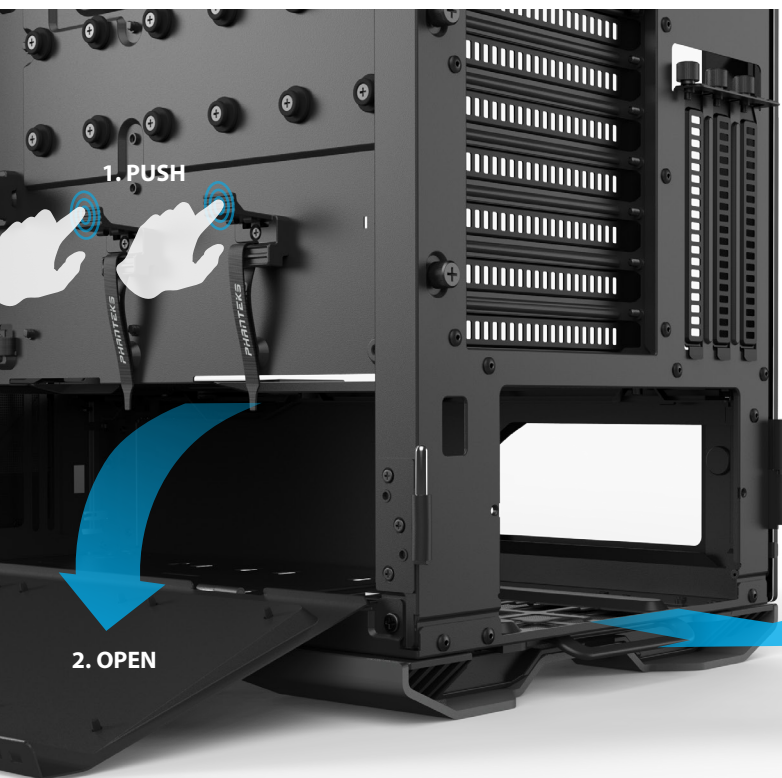
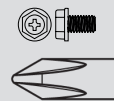

LOOSEN:

2 x



4 x



PRO TIP
Connect all needed cables to the power supply before installing it in the case.

INSTALLING FANS

Configure your airflow-path with this overview. All fan locations support both 120mm and 140mm fans.

REQUIRE:

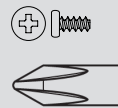

Install the magnetic Airflow Cover to prevent air from recirculating when you install 2x 120 mm or 2x 140 mm fans.

TOP

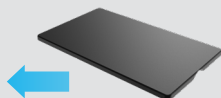
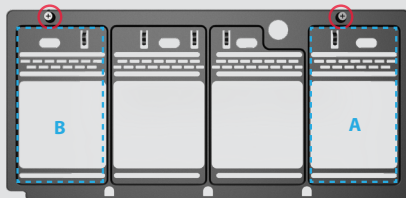
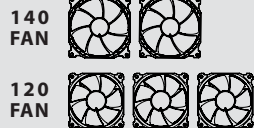

AIRFLOW COVER

FRONT

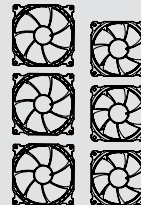

140 FAN

120 FAN

LOOSEN:
2x



REAR

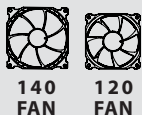

CONNECTING THE UNIVERSAL FAN HUB

1. CONNECT THE FAN HUB 4-PIN CABLE TO YOUR MOTHERBOARD FAN HEADER
2. CONNECT EXTRA FANS TO THE CORRESPONDING CONNECTOR ON THE UNIVERSAL FAN HUB
3. CONNECT THE SATA CABLE TO THE POWER SUPPLY

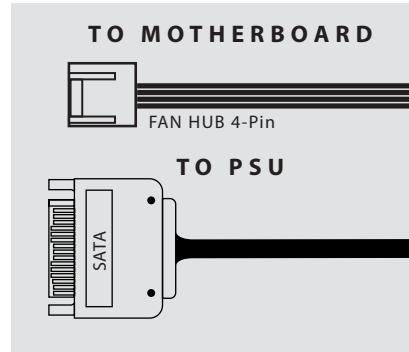

PRO TIP

You can choose a PWM or DC output in the motherboard settings. The Fan Hub will automatically translate the signal to all connected 3- and 4-pin fans. Check WWW.PHANTEKS.COM/FAQ for more technical details.



PRO TIP

Choosing a PWM output provides the most customization options in the motherboard settings.



PRO TIP

Expand the number of fans with splitter cables up to a maximum of 4A total power. Splitter cables are sold separately: **PH-CB-Y4P / Y3P**

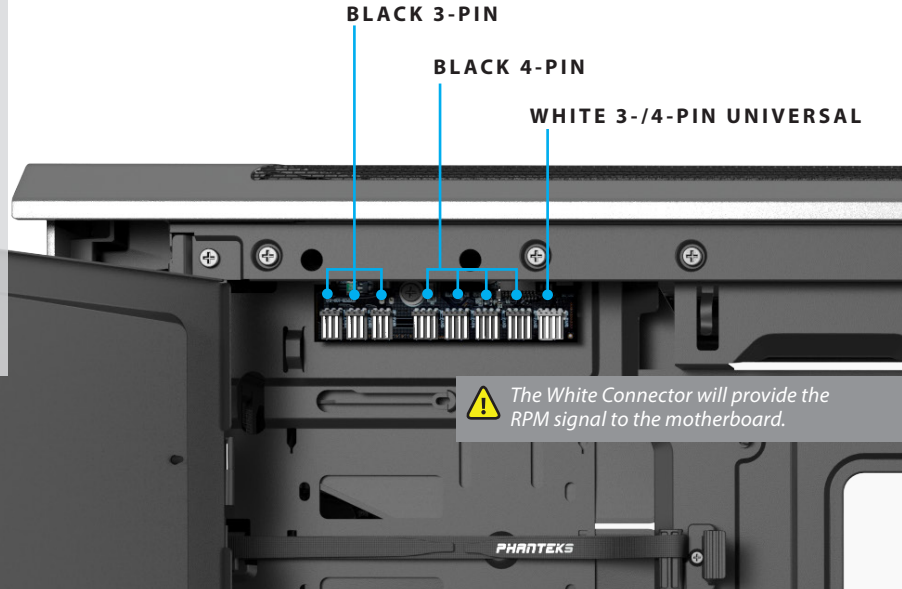

INSTALLING DRIVES

2.5" SSD INSTALLATION

Both SSD Covers support 3x 2.5" SSDs. Each SSD is mounted with 4x screws.

REMOVE:

4 x



4 x



REQUIRE:

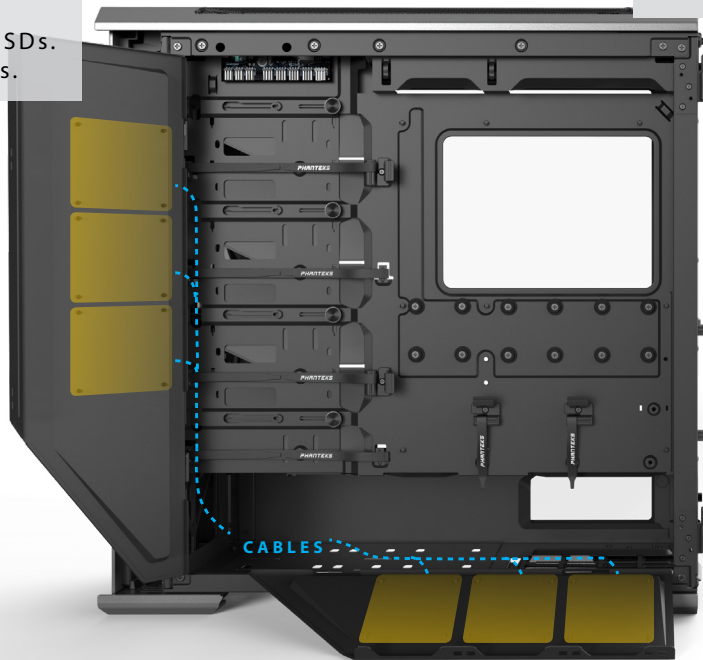
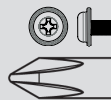

OPTIONAL SSD STORAGE

Up to 3x additional SSDs can be installed using the *Phanteks 2,5" SSD bracket (PH-SDBKT_01).
*SSD brackets are not included and sold separately.

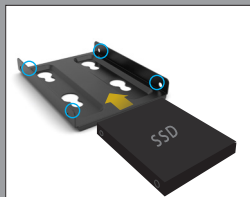

PH-SDBKT_01 required

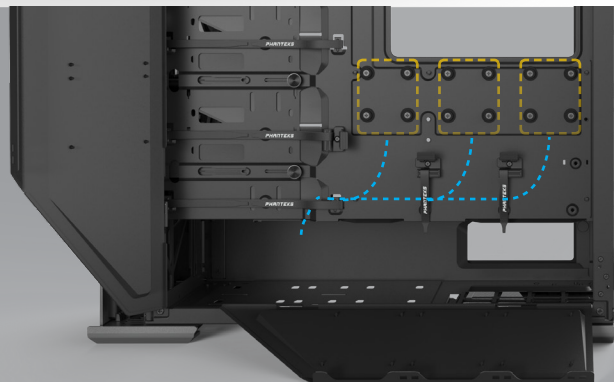

3.5" HDD INSTALLATION

4x Phanteks Stackable 3.5" HDD Brackets are included.
Additional brackets are sold separately (PH-HDDKT_03).

REQUIRE:

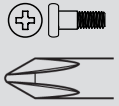

HDD INSTALLATION

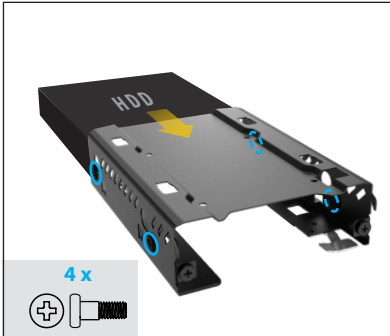

STACK / INSTALL

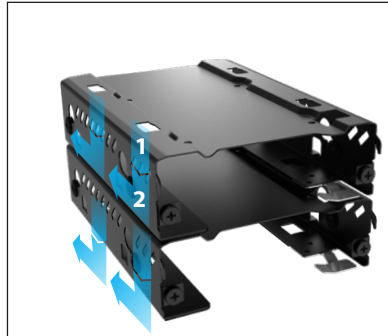

REMOVE

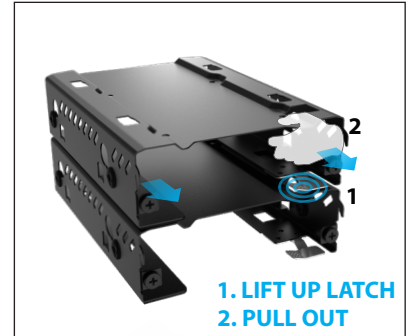

Each HDD bracket can be stacked together to offer more flexibility.



The HDD bracket can also house a 2.5" SSD instead of a 3.5" HDD.

BOTTOM COMPARTMENT

TWO STACK-CONFIGURATION

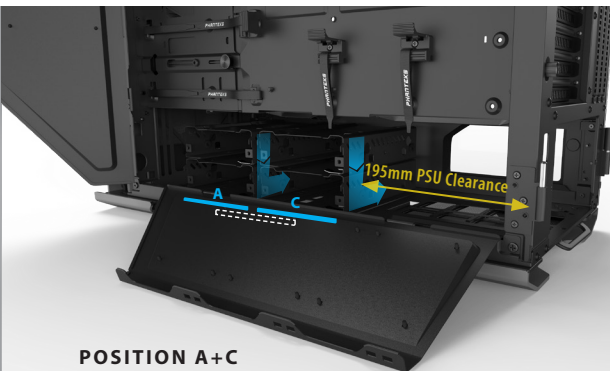

SINGLE STACK-CONFIGURATION

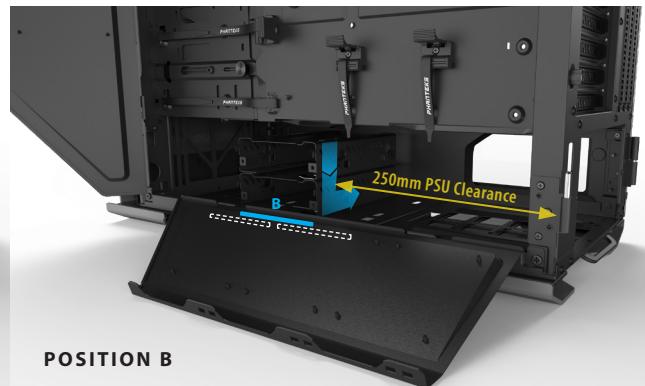

MAIN COMPARTMENT

Up to 6 Stackable HDD Brackets can be installed in the main compartment.

REQUIRE:



Stack the HDD brackets before mounting if you install more than 1x bracket.

1. REMOVE THE CABLE COVER(S) TO REVEAL THE HDD MOUNTS

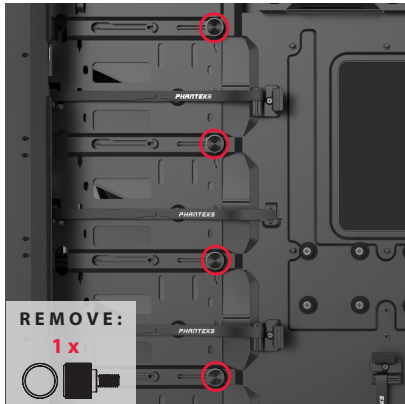

2. MOUNT THE (SINGLE / STACKED) HDD BRACKETS IN POSITION

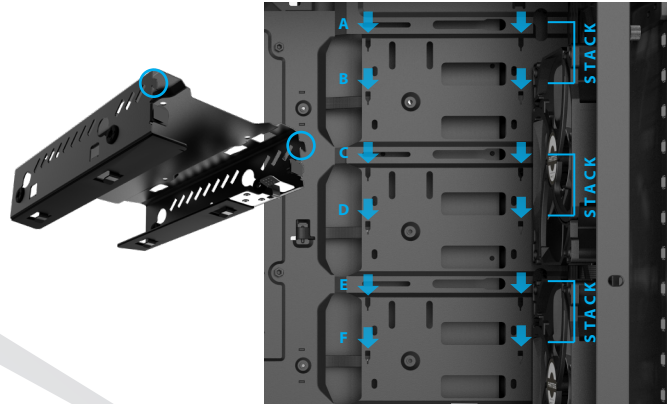

3. SECURE WITH 2 THUMBSCREWS

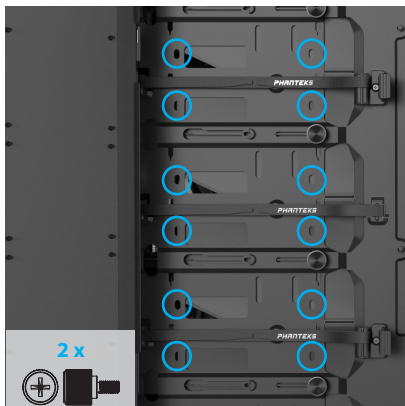

INSTALLING WATER COOLING

REQUIRE:



TOP

120 FORM FACTOR

120

240

360

140 FORM FACTOR

140

280

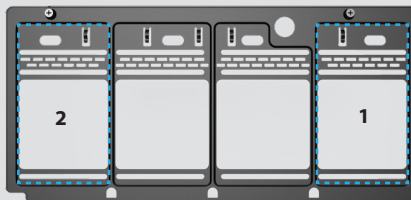

Use the Airflow Cover to prevent hot air from circulating.

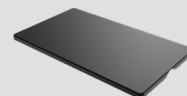

REAR

120 FORM FACTOR

120

140 FORM FACTOR

140



FRONT

120 FORM FACTOR

120

240

360

140 FORM FACTOR

140

280

420

RADIATOR CLEARANCE

TOP

MAX. RADIATOR CLEARANCE

140mm Radiators: **A:**405mm **B:**146mm **C:**65mm

120mm Radiators: **A:**405mm **B:**126mm **C:**65mm*

*If the motherboard and its components (e.g. memory) are 50mm or lower there is no limit in Radiator thickness.

FRONT

MAX. RADIATOR CLEARANCE:

A:465mm **B:**148mm **C:**95mm



Installing a fill port in the top radiator bracket and/or a drain port in the front of the case makes water cooling maintenance much easier.

The port diameters are 20.5mm.

Phanteks Passthrough fitting: **PH-PTF_BK/CR_G1/4**

Phanteks Ball-Valve fitting: **PH-BVA_BK/CR_G1/4**

FILL PORT

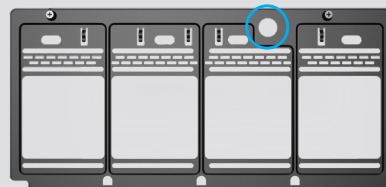

DRAIN PORT



RESERVOIR INSTALLATION

Reservoir mounting points are accessed by removing the Cable Covers.

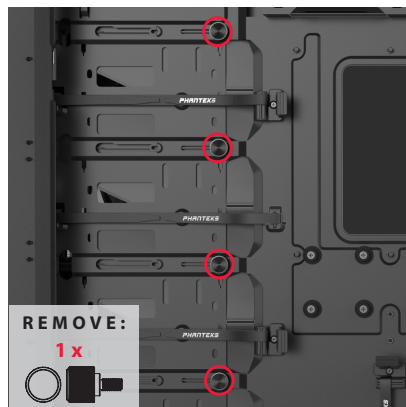
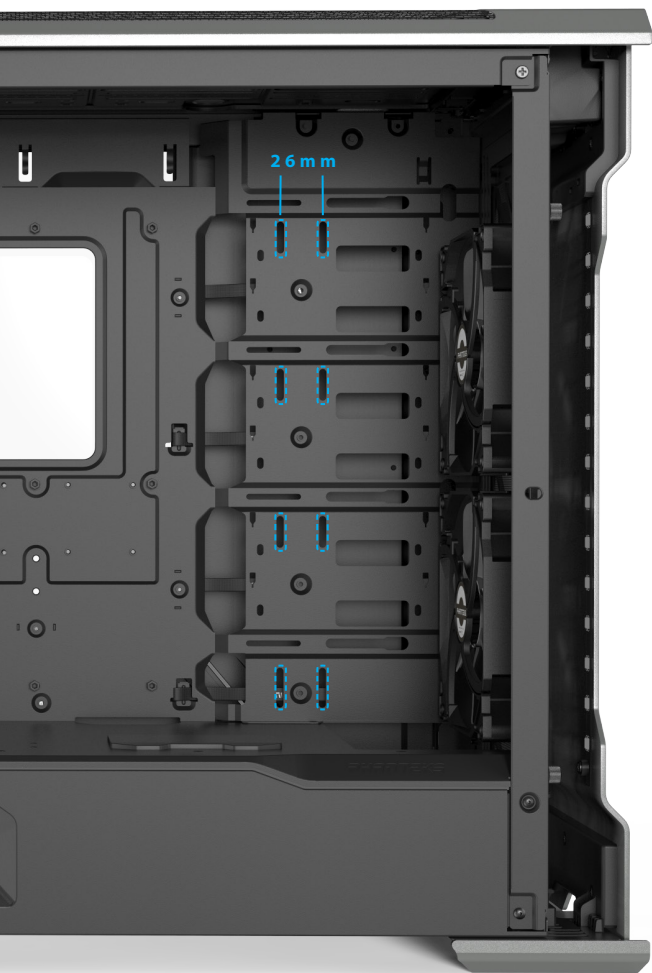

OPTIONAL PUMP BRACKET

The universal Pump Bracket can be installed in the bottom compartment using 4 case screws.

Pump Bracket sold separately
(PH-PUMBKT_01)

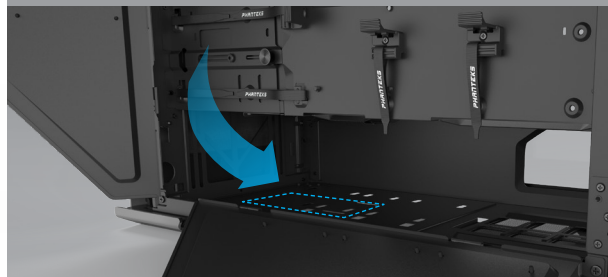
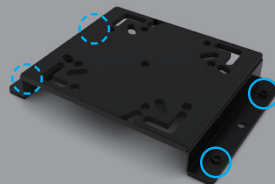

GPU ANTI-SAG BRACKET

To prevent your GPU from tipping down you can install the GPU Anti-Sag Bracket.

REQUIRE:

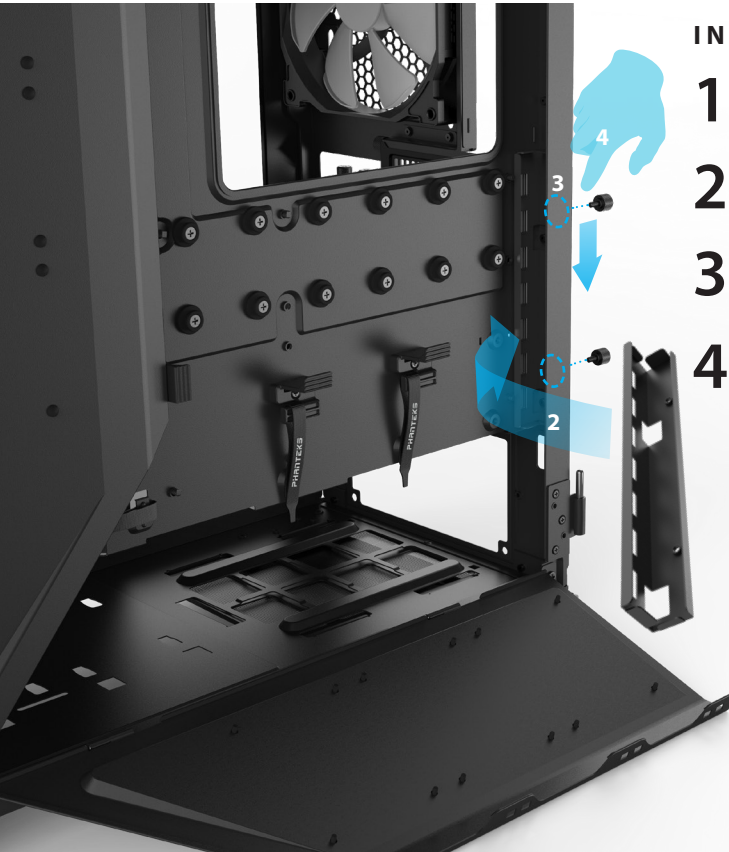
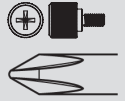

INSTALLING GPU ANTI-SAG BRACKET

1. INSTALL ALL GPU AND PCI CARDS
2. PLACE THE GPU ANTI-SAG BRACKET
3. INSERT THE THUMBSCREWS WITHOUT TIGHTENING THEM
4. PRESS DOWN AND LOCK THE THUMBSCREWS IN POSITION.

2 x



! Always loosen the 2 thumb screws before removing any GPU or PCI card.

CONNECTING FRONT I/O

Please consult the motherboard manual for additional instructions.



There's no POWER LED +/- cable. For powering your Evolv X lighting, please go to page 22.

TO MOTHERBOARD

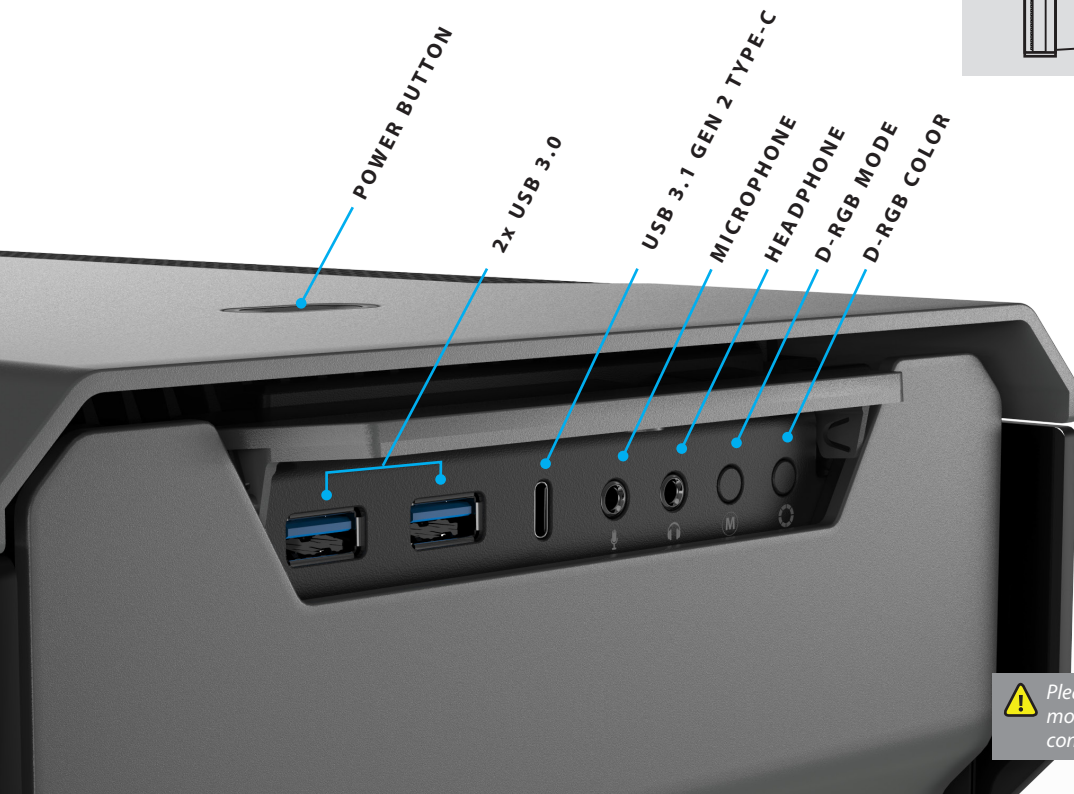
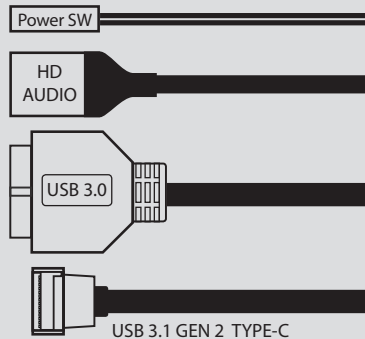

Please make sure to consult your motherboard manual before connecting your front I/O.

D-RGB LIGHTING

The integrated D-RGB lighting is plug-and-play and can be expanded with up to 8 more D-RGB products from Phanteks.

 Please connect the 12V SATA connector to your PSU to power the case lighting.

MODE COLOR





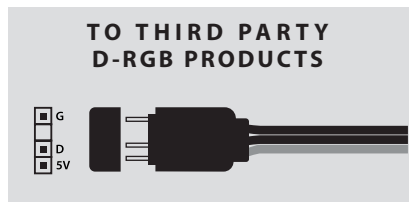
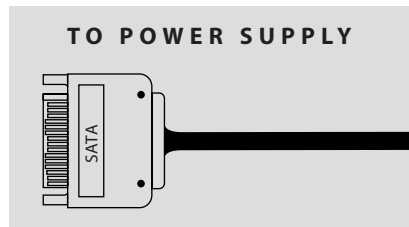
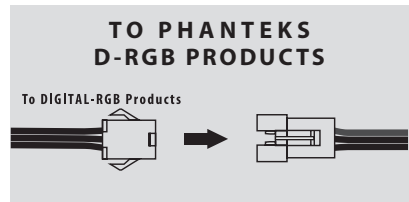

All Phanteks D-RGB products can be Daisy-Chained to optimize cable management.



D-RGB CONTROLS

 **MODE**

-  Solid
-  Breathing
-  Radar
-  Sparkle
-  Rainbow

 **COLOR**

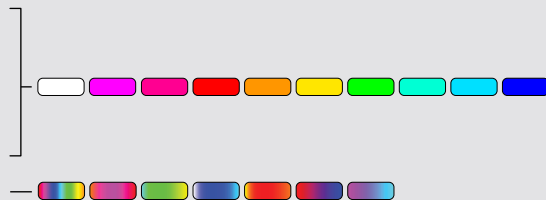

Press & Hold MODE: Turn off Front LED's.

Press & Hold MODE 2 sec again: Turn off all LED's.

SYNC CASE LIGHTING WITH D-RGB COMPATIBLE MOTHERBOARD

1. Connect the D-RGB motherboard connector to the motherboard.

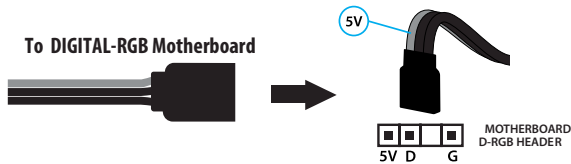

D-RGB MOTHERBOARD ADAPTER



2. Run the Motherboard Lighting software and follow the instructions to set up your lighting.



 Only connect Phanteks D-RGB products to a 3-pin 5V motherboard connector.



MOTHERBOARD D-RGB HEADER

COMPATIBLE WITH



ADDRESSABLE



RAINBOW

CABLE MANAGEMENT

Use the velcro ties to route your cables before closing the SSD Covers. Zip ties are included in the accessory bag to manage any excess cables.

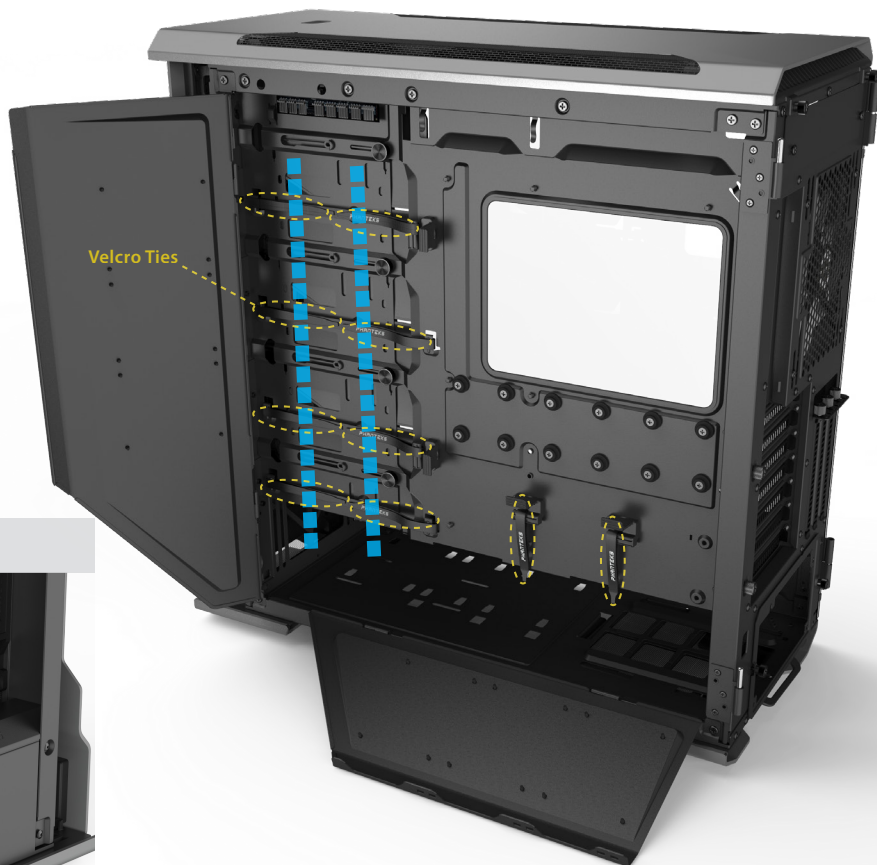

GPU CABLE ROUTING

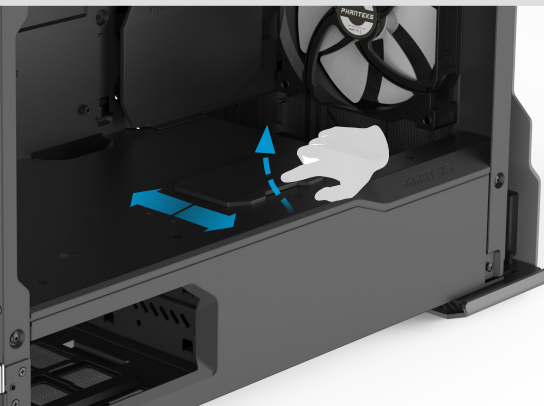

OPTIONAL UPGRADES

2.5" SSD BRACKET

PH-SDBKT_01

For 2.5" SSD Drive

Upgrade up to 3x additional 2.5" SSDs with the optional SSD brackets.

PAGE 14



3.5" STACKABLE HDD BRACKETS PH-HDDKT_03

For 3.5" or 2.5" Drive

Upgrade up to 6x additional 3.5" HDDs with the optional HDD brackets.

PAGE 15

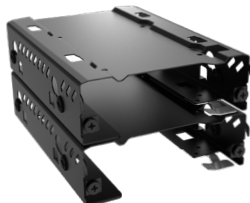

PHANTEKS PH-F120MP / PH-F140MP

High static pressure 120/140 mm fans

More fans can be installed in the Evolv X and connected to the Universal Fan Hub using splitter cables.

PAGE 12



CABLE EXTENSION SET

PH-CBCMB0

- Available in multiple colors
- Includes clear cable combs
- Also available as separate cables

DIGITAL-RGB LED COMBO SET PH-DRGBLED_CMB0

High density Digital-RGB LED strips with magnets

The D-RGB equipped Evolv X is ready to expand with more D-RGB lighting products.

PAGE 22



HALOS (LUX) DIGITAL RGB FAN FRAMES

PH-FF120DRGBA

PH-FF120DRGBP

PH-FF140DRGBA

PH-FF140DRGBP

High density Digital-RGB LED fan frames that illuminate any fan.

The D-RGB equipped Evolv X is ready to expand with more D-RGB lighting products.

PAGE 22



Y-SPLITTER CABLES

PH-CB-Y4P / PH-CB-Y3P

4-pin / 3-pin Fan splitters

More fans can be connected to the Universal Fan Hub using splitter cables.

PAGE 13



Included cables:

- Motherboard 24-pin
- CPU 4+4-pin
- 2x GPU 6+2-pin



220 mm Slimline PCI-E x16 Riser Cable 90°
220 mm Premium Shielded High Speed PCI-E x16 Riser Cable 90°

PH-CBRS_SL22
PH-CBRS_PR22

Vertical GPU installation

With the optional Riser Cable you can place any 2- or 3-slot GPU vertically.

PAGE 27

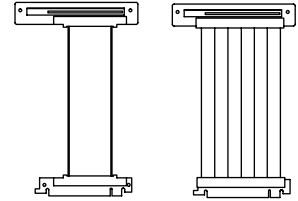

ITX Upgrade Kit

PH-ITXKT_02

Dual System installation

With the optional Riser Cable you can place any 2- or 3-slot GPU vertically for your 2nd ITX system.

PAGE 28



Revolt X Power Supply

PH-P1000PS
PH-P1200PS

Dual System installation

The Revolt X power supply unlocks the Dual System Configuration. But also works great as a “single system” power supply.

PAGE 11



600 mm Premium Shielded High Speed PCI-E x16 Riser Cable 90°

PH-CBRS_PR60

Vertical GPU installation for 2nd system (Dual system configuration)

With the optional Riser Cable you can place any 2- or 3-slot GPU vertically for your 2nd ITX system.

PAGE 29

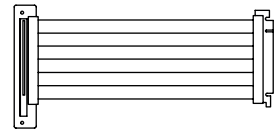

INSTALLING VERTICAL GPU

1. INSTALL RISER CABLE

- Riser Cable sold separately (PH-CBRS_SL22)



2 x



REQUIRE:



2. INSTALL VERTICAL GPU MOUNT WITH 2X SCREWS



2 x



PRO TIP

The GPU Mount has 2 mounting positions. Position A allows for better air cooling and 3-slot GPU cards.

INSTALLING DUAL SYSTEM

ITX Bracket sold separately (PH-ITXKT_02)

 The Revolt X power supply from Phanteks is required for this configuration.

1. REMOVE THE DUAL SYSTEM COVER FROM THE CHASSIS.

REMOVE:

2 x



2. INSTALL YOUR ITX MOTHERBOARD ON THE BRACKET USING THE INCLUDED MOTHERBOARD SCREWS

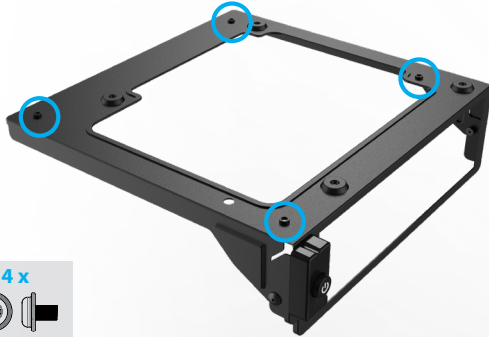

Motherboard screws and ITX bracket screws are included with the ITX bracket (PH-ITXKT_02)

TO ITX MOTHERBOARD

Power SW

Power LED

4 x



3. CONNECT THE POWER SWITCH AND LED CABLE

4. INSTALL THE ITX BRACKET WITH 4X ITX BRACKET SCREWS

4 x



1

4

VERTICAL GPU SECOND SYSTEM

1. INSTALL RISER CABLE

- Riser Cable sold separately (PH-CBRS_PR60)



Depending on your needs, it's not always necessary to install a GPU for your second system when your ITX motherboard is equipped with an onboard GPU.

REQUIRE:



2 x



2. INSTALL VERTICAL GPU MOUNT WITH 2X SCREWS

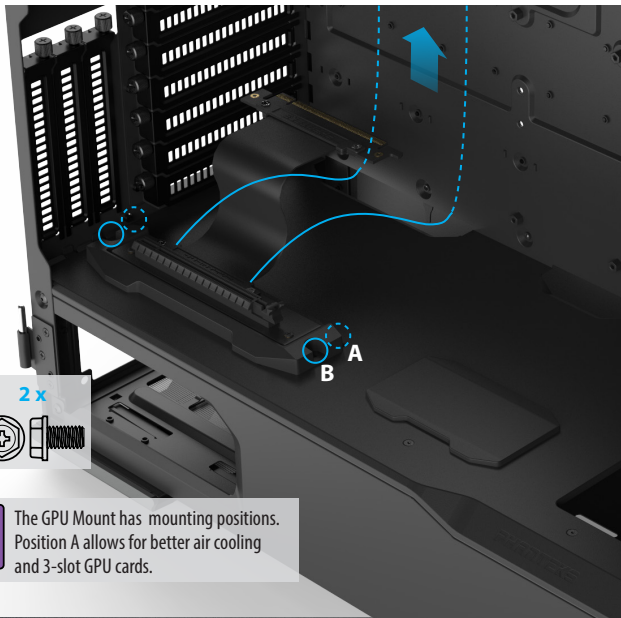

2 x



The GPU Mount has mounting positions. Position A allows for better air cooling and 3-slot GPU cards.

3. MOVE VELCRO TIE

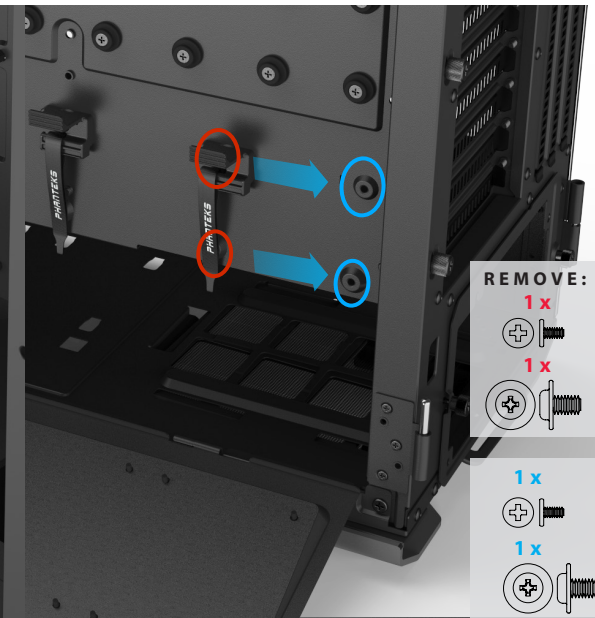

REMOVE:

1 x



1 x



1 x



1 x



CONTACT US

As a Phanteks customer, you are priority number one. We have a dedicated team of employees across the globe working hard every day to make sure we deliver the superior experience you deserve. We are here for you. If you have a question or a concern about our products, we have numerous ways you can reach us. Please choose one most convenient for you to connect with our team.

CUSTOMER CARE

RMA and Technical Support International

Email : support@phanteks.com

Facebook : @Phanteks

RMA and Technical Support Americas

Hours : Monday-Friday 9:00-5:00 PST

Phone number : +1(909)598-2115

Email : support@phanteksusa.com

Facebook : @Phanteks



For up-to-date information please check www.Phenteks.com

EVOLV X PRODUCT PAGE



PHANTEKS FACEBOOK PAGE



WARRANTY

PHANTEKS warrants its products to be free from defects in material and workmanship during the warranty period; when given normal, proper and intended usage. If a product proves to be defective in material or workmanship during the warranty period, PHANTEKS will, at its sole option, repair or replace the product with same product or similar product. The replacement product assumes the remaining warranty of the original product or 30 days, whichever provides longer coverage for the customer.

Duration of warranty:

1. Fans - 5 years
2. I/O Ports - 2 years
3. Fan Hub - 2 years
4. LED Lighting - 2 years
5. Buttons - 2 years
6. Chassis - 5 years
7. Front and Top Panels - 5 years

Please check www.phanteks.com/Warranty for more information.

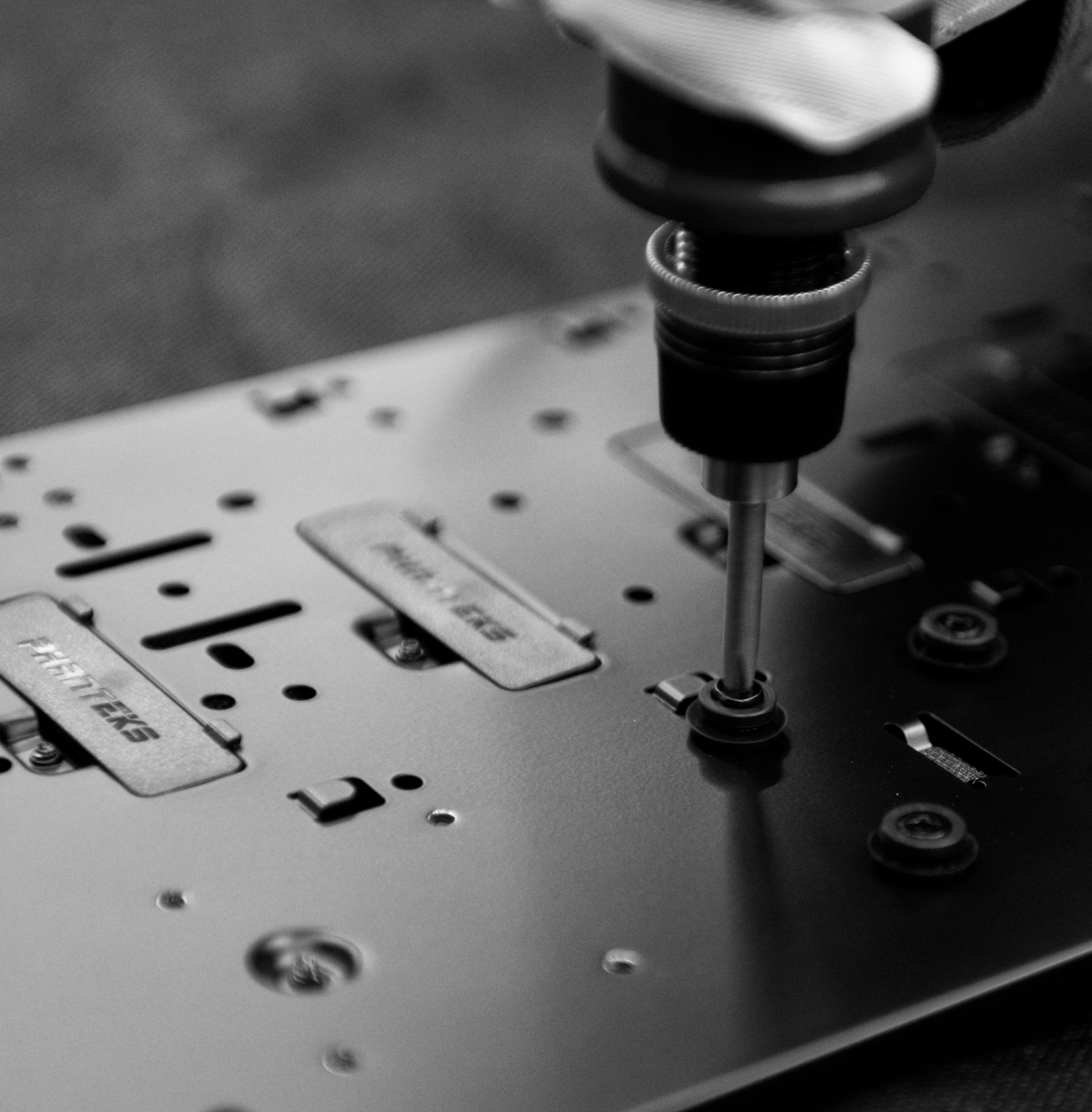

PHANTEKS