

# KA 012 BK

Junction box 86x86x41mm, plastic, RAL 9005

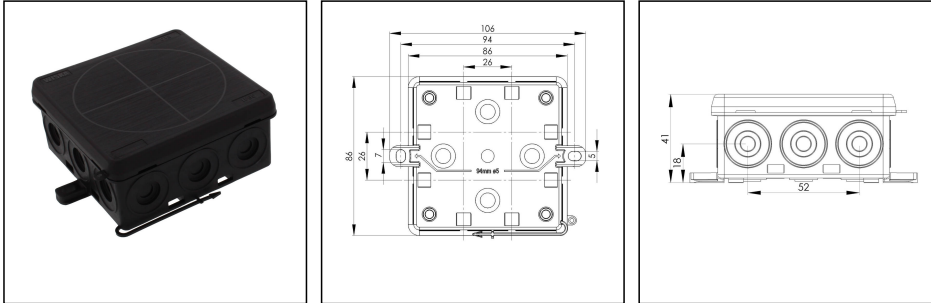

Products may differ in size, colour and appearance to those shown. If you require further information or customisation, please contact us directly.



<b>Material</b>	Polyethylene / Polypropylene
<b>Protection class</b>	IP55
<b>Temp. range min</b>	-30 °C
<b>Temp. range max</b>	60 °C
<b>Temperatures during install.</b>	-5 °C - 60 °C
<b>Glow wire test</b>	750 °C
<b>Voltage</b>	400 V
<b>Rated cross section</b>	4 mm <sup>2</sup>
<b>Fixing</b>	2 external mounting feet
<b>Ø cable diameter min</b>	7 mm
<b>Ø cable diameter max</b>	12 mm
<b>External dimensions LxWxH</b>	86 x 86 x 41 mm
<b>Using for cable gland</b>	
<b>Product Color</b>	RAL 9005
<b>Order no. RAL 9005</b>	10109587
<b>Type</b>	KA 012 BK
<b>Packing unit</b>	10
<b>EAN number</b>	4007686094923
<b>Tariff number</b>	39269097
<b>ETIM-Classification</b>	EC002600

Remarks:

Fixture: with cable ties, 2 external mounting feet

Equipment: 12 self-sealing, cutable cable entries at the side, 4 on the bottom  
captive cover

Your Contact:

**WISKA Hoppmann GmbH**  
Kisdorfer Weg 28 · 24568 Kaltenkirchen · Germany  
☎ +49-4191-508-0 · 📠 +49-4191-508-209  
contact@wiska.de · www.wiska.com

**Recommended accessories**

<b>ZER 4-12 LG</b>	10109800
<b>ESD 30 LG</b>	10109875
<b>ESV LG</b>	10109876
<b>EDV LG</b>	10109877
<b>ZER 11-18 LG</b>	10110766
<b>SP-KT 11/5 Terminal block</b>	22000409

20.09.2023

Your Contact:

**WISKA Hoppmann GmbH**

Kisdorfer Weg 28 · 24568 Kaltenkirchen · Germany

☎ +49-4191-508-0 · 📠 +49-4191-508-209

contact@wiska.de · www.wiska.com

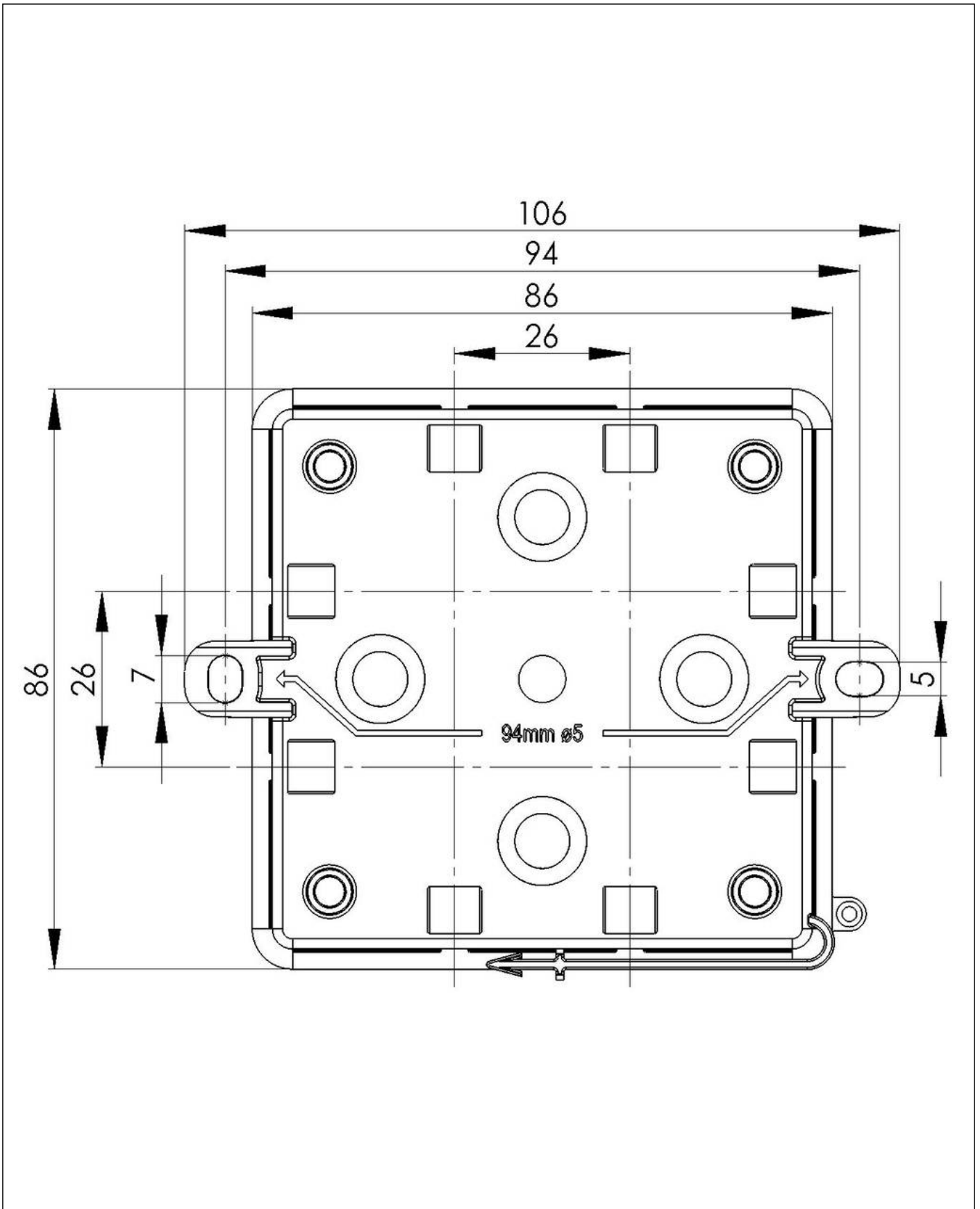

Your Contact:

**WISKA Hoppmann GmbH**

Kisdorfer Weg 28 · 24568 Kaltenkirchen · Germany

☎ +49-4191-508-0 · 📠 +49-4191-508-209

contact@wiska.de · www.wiska.com

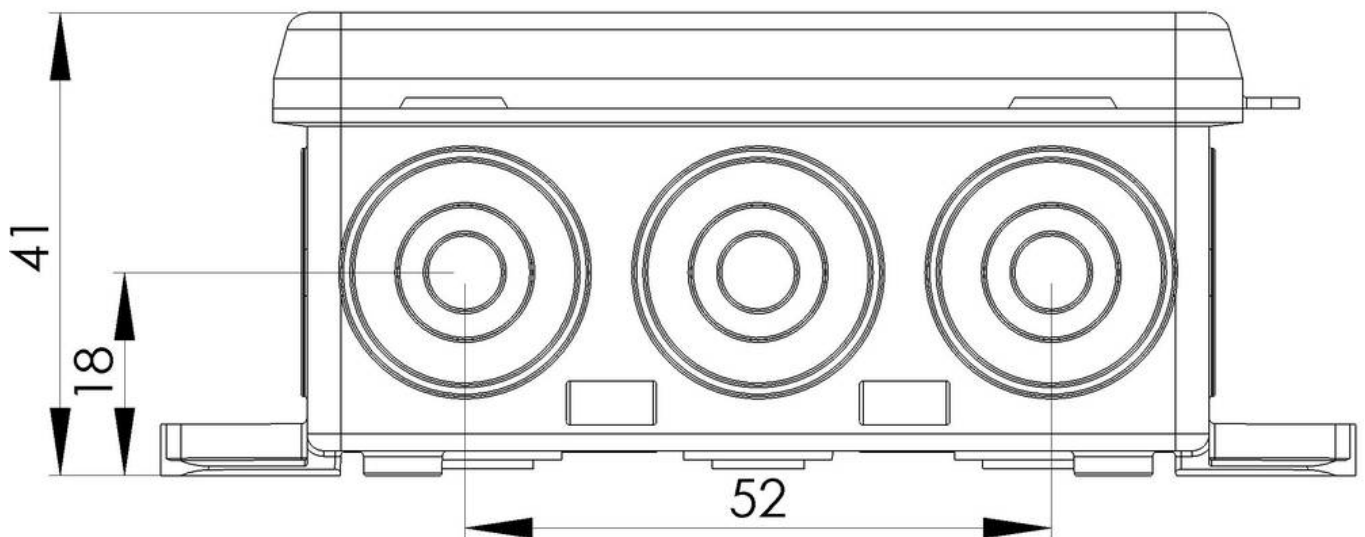

Your Contact:

**WISKA Hoppmann GmbH**

Kisdorfer Weg 28 · 24568 Kaltenkirchen · Germany

☎ +49-4191-508-0 · 📠 +49-4191-508-209

contact@wiska.de · www.wiska.com