

## D-SERIES DRM DRMKIT 230VAC 2CO LD/PB

**Weidmüller Interface GmbH & Co. KG**  
Klingenbergstraße 16  
D-32758 Detmold  
Germany  
Fon: +49 5231 14-0  
Fax: +49 5231 14-292083  
www.weidmueller.com

### Product image



Our relay kits are particularly convenient to use. The kits are delivered fully assembled and 100 % function-tested. This saves assembly time and reduces the number of parts required.

- Assembled kit consisting of relay, base and retaining clip, incl. label
- 100% function-tested
- 100% control of the dielectric strength input - output
- Optional: test button with coloured control voltage marking (AC coil: red / DC coil: blue) and mechanical switch position indicator
- Bright status LED (AC coil: red / DC coil: green)

### General ordering data

Type	DRMKIT 230VAC 2CO LD/PB
Order No.	<a href="#">1542490000</a>
Version	D-SERIES DRM, Relays, No. of contacts: 2 CO contact with test button AgNi 0,15 µm Au, Rated control voltage: 230 V AC, Continuous current: 10 A, Screw connection
GTIN (EAN)	4050118347135
Qty.	10 pc(s).

**D-SERIES DRM**  
**DRMKIT 230VAC 2CO LD/PB**

**Weidmüller Interface GmbH & Co. KG**  
 Klingenbergstraße 16  
 D-32758 Detmold  
 Germany  
 Fon: +49 5231 14-0  
 Fax: +49 5231 14-292083  
 www.weidmueller.com

**Technical data****Dimensions and weights**

Width	27.2 mm	Width (inches)	1.071 inch
Height	79.9 mm	Height (inches)	3.146 inch
Depth	66.8 mm	Depth (inches)	2.63 inch
Net weight	91.1 g		

**Temperatures**

Operating temperature, max.	55 °C	Operating temperature, min.	-40 °C
Storage temperature, max.	70 °C	Storage temperature, min.	-40 °C
Operating temperature	-40 °C...55 °C	Storage temperature	-40 °C...70 °C

**Environmental Product Compliance**

REACH SVHC	Lead 7439-92-1
------------	----------------

**Input**

Rated control voltage	230 V AC	Rated current AC	6.1 mA (50 Hz), 5.2 mA (60 Hz)
Power rating	1.0...1.2VA (60HZ)	Pull-in/drop-out voltage, typ.	184 V / 69 V AC
Coil resistance	16000 Ω ± 10 %	Status indicator	red LED

**Output**

Rated switching voltage	250 V AC	Max. switching voltage, AC	250 V
Continuous current	10 A	Inrush current	20 A / 50 ms
Switch-on delay	< 20 ms	Switch-off delay	< 20 ms
Min. switching power	10 mA @ 12 V, 100 mA @ 5 V	Max. switching frequency at rated load	0.1 Hz

**Contact data**

Contact type	2 CO contact with test button (AgNi 0,15 µm Au)	Contact resistance	≤ 50 mΩ
Mechanical service life	20 x 10 <sup>6</sup> switching cycles		

**General data**

Rail	TS 35	Test button	yes (lockable)
Mechanical switch position indicator	Yes	Colour	black
UL 94 flammability rating	V-0		

**Insulation coordination**

Rated voltage	250 V	Surge voltage category	III
Pollution severity	2	Insulating material group	C
Protection degree	IP20	Dielectric strength, Input/Output	1.8 kV <sub>eff</sub> / 1 min.
Creepage and clearance distance input – output	≥ 5.5 mm	Dielectric strength of neighbouring contacts	1 kV <sub>eff</sub> / 1 min
Dielectric strength of open contact	1 kV <sub>eff</sub> / 1 min	Impulse withstand voltage	4.8 kV (1.2/50 µs)

**Further details of approvals / standards**

Certificate no. (cURus) relay	E312083	Certificate no. (cURus) base	E312083
-------------------------------	---------	------------------------------	---------

Creation date May 27, 2019 5:23:28 PM CEST

## D-SERIES DRM DRMKIT 230VAC 2CO LD/PB

**Weidmüller Interface GmbH & Co. KG**  
 Klingenbergstraße 16  
 D-32758 Detmold  
 Germany  
 Fon: +49 5231 14-0  
 Fax: +49 5231 14-292083  
 www.weidmueller.com

## Technical data

### Connection data

Wire connection method	Screw connection	Stripping length, rated connection	7 mm
Tightening torque, min.	0.5 Nm	Tightening torque, max.	0.7 Nm
Clamping range, min.	0.5 mm <sup>2</sup>	Clamping range, max.	2.5 mm <sup>2</sup>
Wire cross-section, solid, min.	0.5 mm <sup>2</sup>	Wire cross-section, solid, max.	2.5 mm <sup>2</sup>
Wire connection cross-section, finely stranded, min.	0.5 mm <sup>2</sup>	Wire connection cross section, finely stranded, max.	2.5 mm <sup>2</sup>
Wire connection cross-section, finely stranded with wire-end ferrules DIN 46228/4, min.	0.5 mm <sup>2</sup>	Wire connection cross-section, finely stranded with wire-end ferrules DIN 46228/4, max.	2.5 mm <sup>2</sup>
Conductor cross-section, flexible, AEH (DIN 46228-1), min.	0.5 mm <sup>2</sup>	Conductor cross-section, flexible, AEH (DIN 46228-1), max.	2.5 mm <sup>2</sup>
Wire connection cross section, finely stranded, two clampable wires, min.	0.5 mm <sup>2</sup>	Wire cross-section, finely stranded, two clampable wires, max.	1 mm <sup>2</sup>
Blade size	size PH1		

### Classifications

ETIM 5.0	EC001437	ETIM 6.0	EC001437
eClass 6.2	27-37-16-90	eClass 7.1	27-37-16-01
eClass 8.1	27-37-16-01	eClass 9.0	27-37-16-01
eClass 9.1	27-37-16-01		

### Approvals

ROHS	Conform
------	---------

### Downloads

Approval/Certificate/Document of Conformity	<a href="#">DE_PA_5600_160317_001.pdf</a>
Engineering Data	<a href="#">EPLAN, WSCAD, Zuken E3.S</a>
Engineering Data	<a href="#">STEP</a>

**D-SERIES DRM  
DRMKIT 230VAC 2CO LD/PB**

**Weidmüller Interface GmbH & Co. KG**  
 Klingenbergstraße 16  
 D-32758 Detmold  
 Germany  
 Fon: +49 5231 14-0  
 Fax: +49 5231 14-292083  
 www.weidmueller.com

**Drawings**

**Wiring diagram**

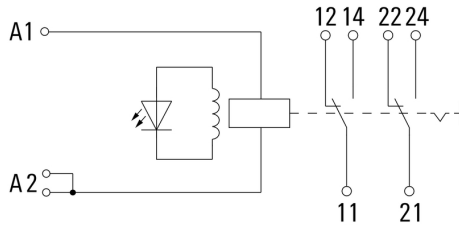

**Graph**

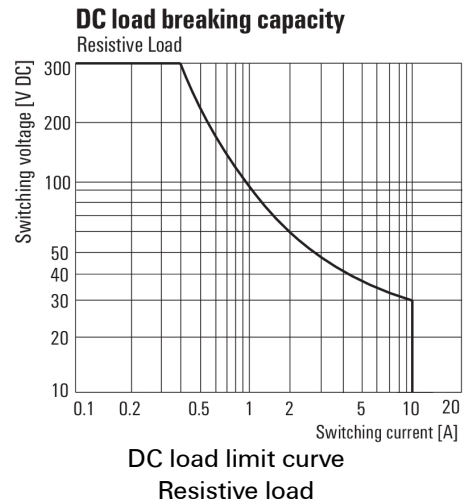

**Graph**

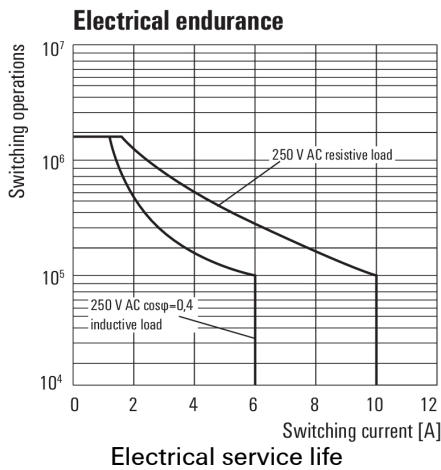

**Graph**

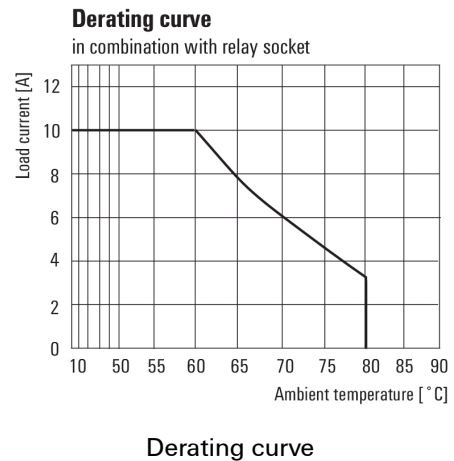

**Graph**

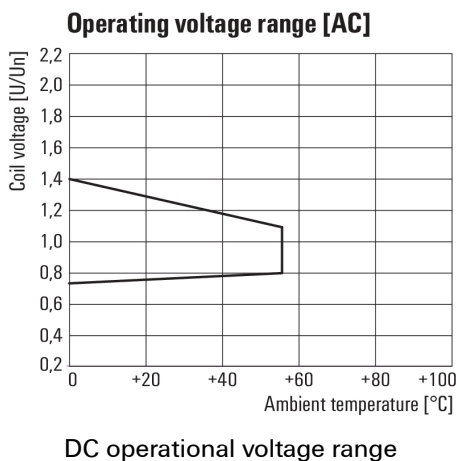

**Dimensional drawing**

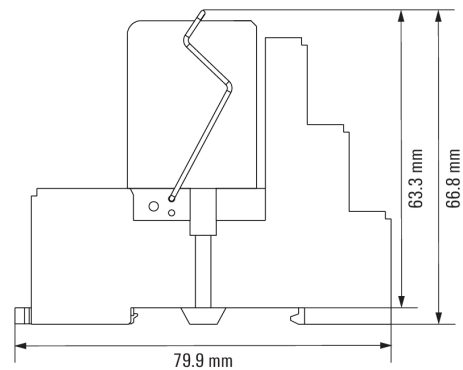

**Data sheet**

**D-SERIES DRM  
DRMKIT 230VAC 2CO LD/PB**

**Weidmüller Interface GmbH & Co. KG**  
 Klingenbergstraße 16  
 D-32758 Detmold  
 Germany  
 Fon: +49 5231 14-0  
 Fax: +49 5231 14-292083  
 www.weidmueller.com

**Drawings**

**Miscellaneous**

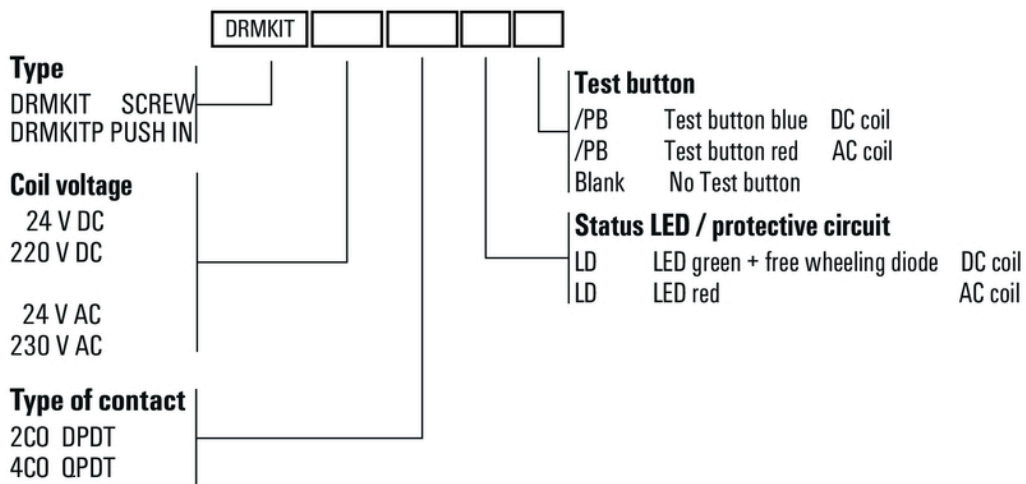

Type codes