

Inverting remote on-off cable (ASS030550100)

The Inverting remote on-off cable is intended for products which require active pull down of the remote control terminal to switch on, while the source signal turns high when switch on is required.

The load output of an MPPT 75/15 or MPPT 100/15, for example, can be used to control an inverter. Some inverters will switch on when the remote control input is pulled high. The remote control input of other inverters must be pulled down to switch on.

Pull down to switch on is needed for the Victron inverters model Phoenix 12/180, 24/180, 12/350 and 24/350. These inverters should be interfaced to the load output of the MPPT 75/15 or MPPT 100/15 with the inverting remote on-off cable.

All Phoenix Inverters rated at 3kVA and more and all Multi C's, Multi's and Quattro's also require active pull down to switch on, and the inverting remote on-off cable can be used to interface between the remote on-off terminal and a source signal that turns high when switch on is required.

Example 1:

Inverting remote on-off cable (1) used to interface between the load output of the MPPT 75/15 or MPPT 100/15 and the Phoenix inverters model 12/180, 24/180, 12/350, 24/350.

(The Victron inverters model Phoenix 12/800, 24/800, 12/1200 and 24/1200 require active pull up to switch on and can be controlled by connecting the right side connection of the inverter remote control directly to the load output of the solar charger)

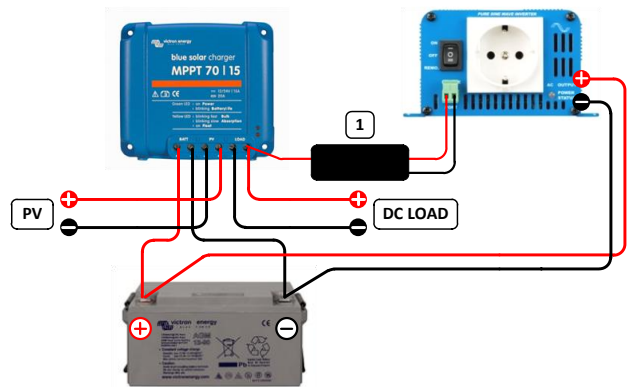

Example 2:

Inverting remote on-off cable (1) used to interface between the load disconnect output of the VE.BUS BMS and the Phoenix inverters model 12/180, 24/180, 12/350, 24/350, 48/350.

Similarly, the Inverting remote on-off cable can be used to interface between the VE.BUS BMS and Phoenix Inverters rated at 3kVA and more.

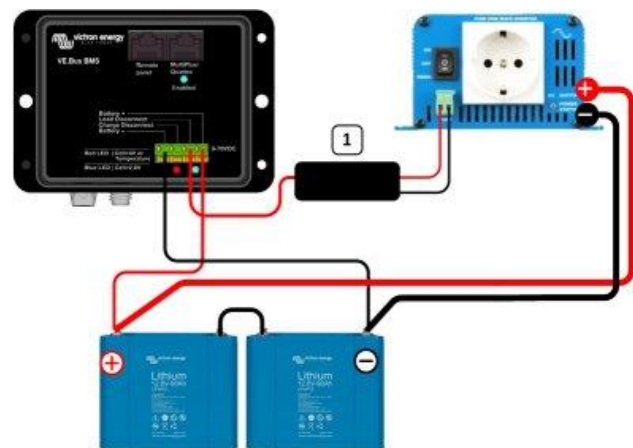

Specifications:

Maximum input voltage: 70 V

Maximum output voltage: 70 V

Minimum input voltage needed for pull down: approximately 6 V

Maximum pull down current: approximately 30 mA (short circuit proof)