

D-Sub Connectors

DB-Series – Solder Cup

Insulator:	Glass filled Polyester, UL94 V-0
Colour:	Black or White
Shell:	Stamped Steel, Tin Plated
Contact pins:	Copper Alloy, Stamped & Formed
Contact Plating:	Selective Gold over Nickel 100 inserts min.

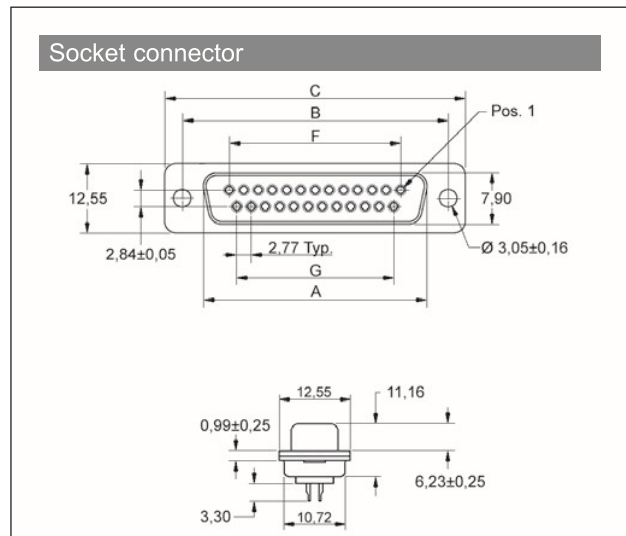
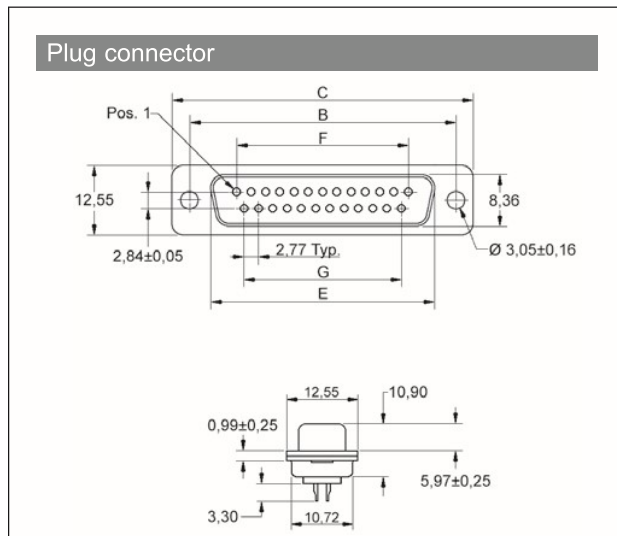

Size	A	B	C	E	F	G
9	16,92	24,99	30,81	16,33	11,08	8,31
15	25,25	33,32	39,14	24,66	19,39	16,62
25	38,96	47,04	53,04	38,38	33,24	30,47
37	55,25	63,50	69,32	54,84	49,86	47,09
50	Available on request					

Order Codes - Standard Type - with Ø 3.05mm Through Hole

BLACK INSULATOR

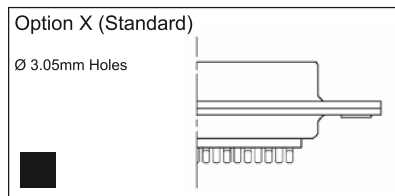

Plug Connector		
09	2101-0180-01	DB09-SP
15	2101-0180-02	DB15-SP
25	2101-0180-03	DB25-SP
37	2101-0180-04	DB37-SP
50	2101-0180-05	DB50-SP

Socket Connector		
09	2101-0180-11	DB09-SS
15	2101-0180-12	DB15-SS
25	2101-0180-13	DB25-SS
37	2101-0180-14	DB37-SS
50	2101-0180-15	DB50-SS

Order Codes - Standard Type - with Ø 3.05mm Through Hole

WHITE INSULATOR

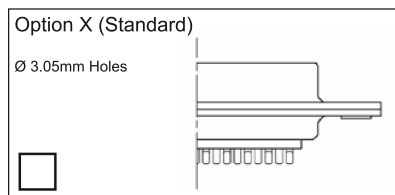

Plug Connector		
09	2108-0180-01	DB09-SP-W
15	2108-0180-02	DB15-SP-W
25	2108-0180-03	DB25-SP-W
37	2108-0180-04	DB37-SP-W
50	2108-0180-05	DB50-SP-W

Socket Connector		
09	2108-0180-11	DB09-SS-W
15	2108-0180-12	DB15-SS-W
25	2108-0180-13	DB25-SS-W
37	2108-0180-14	DB37-SS-W
50	2108-0180-15	DB50-SS-W



Encitech AB
Rörkullsvägen 4
SE-302 41 HALMSTAD, Sweden

Tel: +46-(0)35-15 13 90
e-mail: connectors@encitech.com

www.encitech.com

D-Sub Connectors

Order Codes - Option K - Back Nut UNC 4-40

BLACK INSULATOR

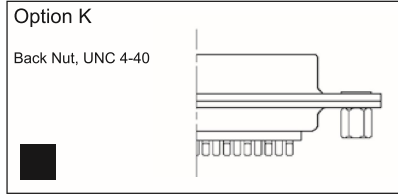

Plug Connector		
09	2101-0181-01	DB09-SP-K
15	2101-0181-02	DB15-SP-K
25	2101-0181-03	DB25-SP-K
37	2101-0181-04	DB37-SP-K
50	2101-0181-05	DB50-SP-K

Socket Connector		
09	2101-0181-11	DB09-SS-K
15	2101-0181-12	DB15-SS-K
25	2101-0181-13	DB25-SS-K
37	2101-0181-14	DB37-SS-K
50	2101-0181-15	DB50-SS-K

Order Codes - Option K - Back Nut UNC 4-40

WHITE INSULATOR

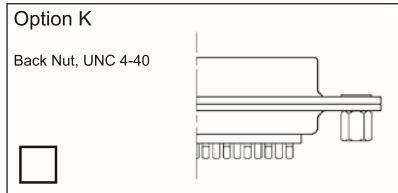

Plug Connector		
09	2108-0181-01	DB09-SP-W-K
15	2108-0181-02	DB15-SP-W-K
25	2108-0181-03	DB25-SP-W-K
37	2108-0181-04	DB37-SP-W-K
50	2108-0181-05	DB50-SP-W-K

Socket Connector		
09	2108-0181-11	DB09-SS-W-K
15	2108-0181-12	DB15-SS-W-K
25	2108-0181-13	DB25-SS-W-K
37	2108-0181-14	DB37-SS-W-K
50	2108-0181-15	DB50-SS-W-K

Order Codes - Option J - Front Nut UNC 4-40

BLACK INSULATOR

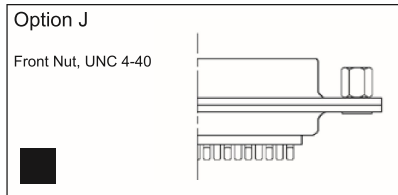

Plug Connector		
09	2101-0182-01	DB09-SP-J
15	2101-0182-02	DB15-SP-J
25	2101-0182-03	DB25-SP-J
37	2101-0182-04	DB37-SP-J
50	2101-0182-05	DB50-SP-J

Socket Connector		
09	2101-0182-11	DB09-SS-J
15	2101-0182-12	DB15-SS-J
25	2101-0182-13	DB25-SS-J
37	2101-0182-14	DB37-SS-J
50	2101-0182-15	DB50-SS-J

Order Codes - Option J - Front Nut UNC 4-40

WHITE INSULATOR

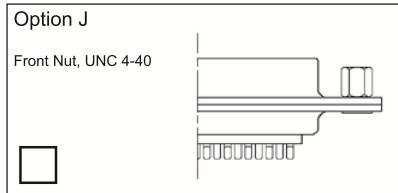

Plug Connector		
09	2108-0182-01	DB09-SP-W-J
15	2108-0182-02	DB15-SP-W-J
25	2108-0182-03	DB25-SP-W-J
37	2108-0182-04	DB37-SP-W-J
50	2108-0182-05	DB50-SP-W-J

Socket Connector		
09	2108-0182-11	DB09-SS-W-J
15	2108-0182-12	DB15-SS-W-J
25	2108-0182-13	DB25-SS-W-J
37	2108-0182-14	DB37-SS-W-J
50	2108-0182-15	DB50-SS-W-J

Order Codes - Option KJ - Back Nut + Screw Nut UNC 4-40

BLACK INSULATOR

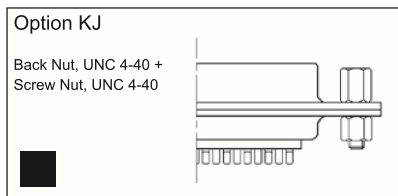

Plug Connector		
09	2101-0183-01	DB09-SP-KJ
15	2101-0183-02	DB15-SP-KJ
25	2101-0183-03	DB25-SP-KJ
37	2101-0183-04	DB37-SP-KJ
50	2101-0183-05	DB50-SP-KJ

Socket Connector		
09	2101-0183-11	DB09-SS-KJ
15	2101-0183-12	DB15-SS-KJ
25	2101-0183-13	DB25-SS-KJ
37	2101-0183-14	DB37-SS-KJ
50	2101-0183-15	DB50-SS-KJ

Order Codes - Option KJ - Back Nut + Screw Nut UNC 4-40

WHITE INSULATOR

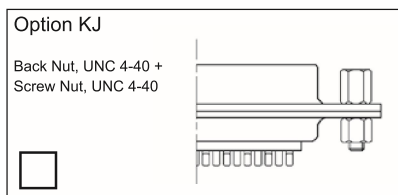

Plug Connector		
09	2108-0183-01	DB09-SP-W-KJ
15	2108-0183-02	DB15-SP-W-KJ
25	2108-0183-03	DB25-SP-W-KJ
37	2108-0183-04	DB37-SP-W-KJ
50	2108-0183-05	DB50-SP-W-KJ

Socket Connector		
09	2108-0183-11	DB09-SS-W-KJ
15	2108-0183-12	DB15-SS-W-KJ
25	2108-0183-13	DB25-SS-W-KJ
37	2108-0183-14	DB37-SS-W-KJ
50	2108-0183-15	DB50-SS-W-KJ

