

Product Data Sheet 6318/2TDHHP

ebmpapst

The engineer's choice



6318/2TDHHP

INDEX

1	General	3
2	Mechanics	3
2.1	General	3
2.2	Connections	3
3	Operating Data	4
3.1	Electrical Interface - Input	4
3.2	Electrical Operating Data	5
3.3	Electrical Interface - Output	6
3.4	Electrical Features	6
3.5	Aerodynamics	8
3.6	Sound Data	9
4	Environment.....	9
4.1	General	9
4.2	Climatic Requirements.....	9
5	Safety	10
5.1	Electrical Safety	10
5.2	Approval Tests	10
6	Reliability.....	10
6.1	General	10

1 General

Fan type	Fan	
Rotating direction looking at rotor	Counterclockwise	
Airflow direction	Air outlet over struts	
Bearing system	Ball bearing	
Mounting position - shaft	Any	

2 Mechanics

2.1 General

Depth	51,0 mm	
Diameter	172,0 mm	
Mass	0,875 kg	
Housing material	Metal	
Impeller material	Plastic	
Max. torque when mounted across both mounting flanges Screw size	Wire outlet corner: 600 Ncm Remaining corners: 600 Ncm ISO 4762 - M4 degreased, without an additional brace and without washer	

2.2 Connections

Electrical connection	Wires	
Lead wire length	L = 365 mm	
Tolerance	+ - 10,0 mm	
Tube length	S = 10 mm	
Tolerance	+ - 2,0 mm	

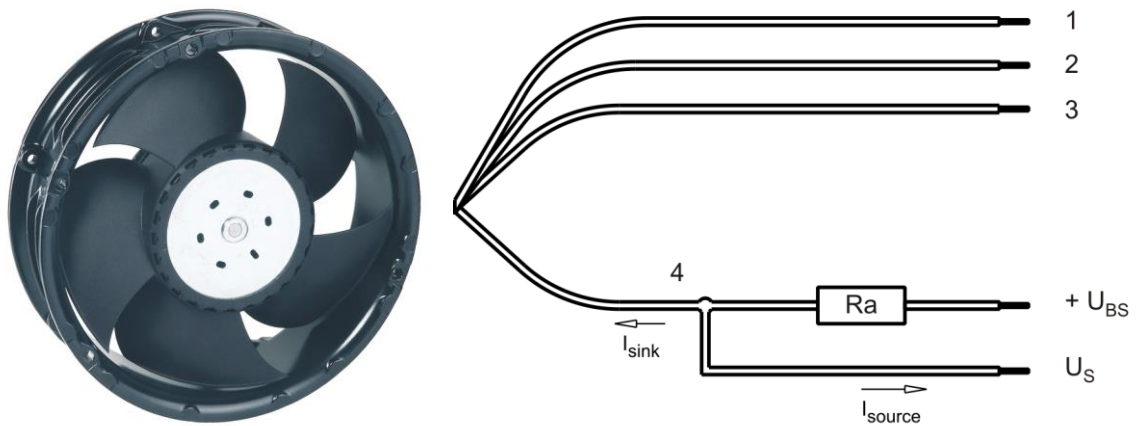

Wire	Color	Operation	Wire size	Insulation diameter
1	red	+ UB	AWG 22	1,7 mm
2	blue	- GND	AWG 22	1,7 mm
3	violet	PWM	AWG 22	1,7 mm
4	white	Tacho	AWG 22	1,7 mm

The auxiliaries shown on the schematic diagram (which are required for the intended use) are not part of our delivery.

3 Operating Data

3.1 Electrical Interface - Input

Control input	PWM
---------------	-----

Features

Input type	Open collector	
PWM - Frequency		typical: 2 kHz
Input frequency range		1 kHz - 20 kHz

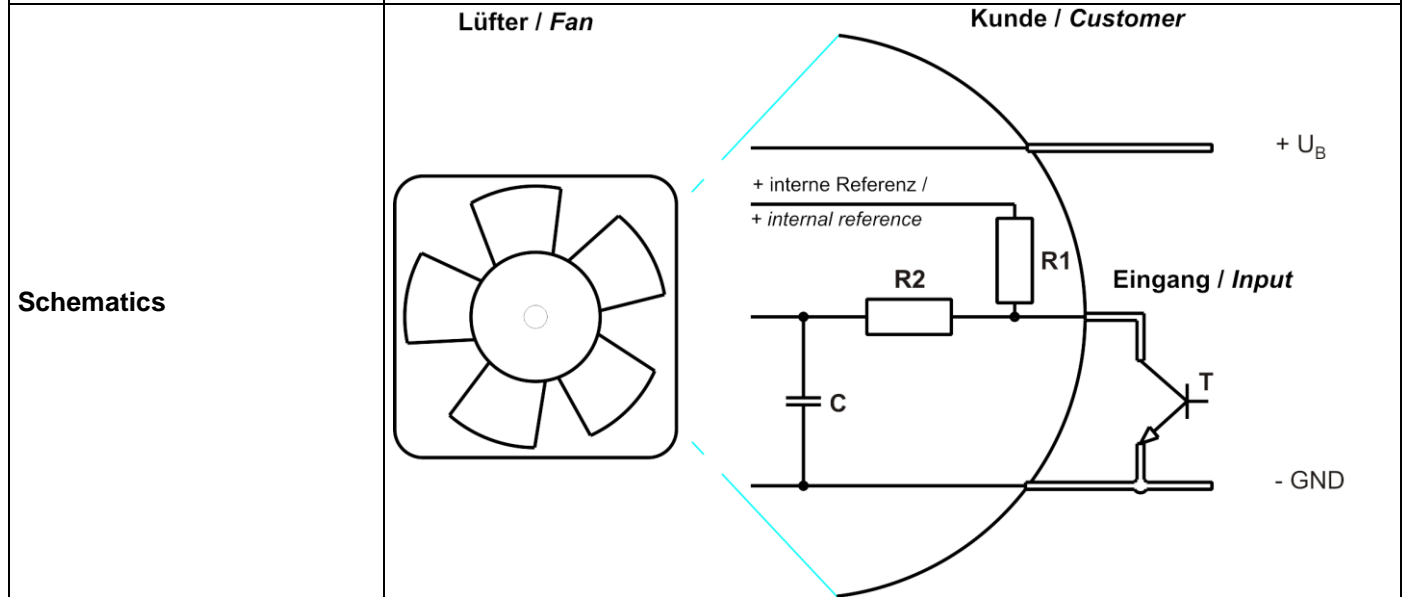
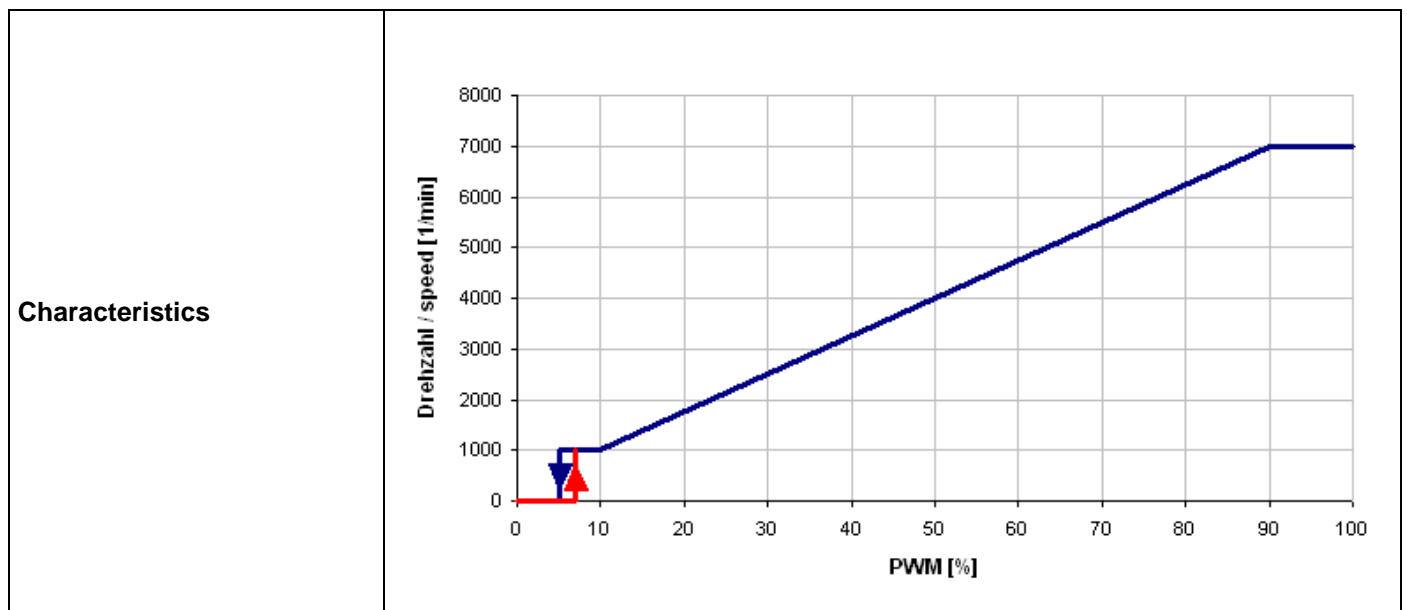

The shown pull-up resistor R1 to the internale reference voltage (+5V) has a resistance of 4.7kOhm.

Transistor requirements:

U_{ce} max. >= 12V; I_{sink} max. >= 5mA; U_{ce} sat. <= 0,15V

Information to the curve:

- 0 % - <=7% PWM: 0 1/min
- 7 % - 10% PWM: 1.000 1/min (corresponding to min. speed)
- 10 % - 90% PWM: linear increasing curve
- 90 % - 100% PWM: 7.000 1/min (corresponding to max. speed)
- 7 % PWM: 1.000 1/min (Fan on, coming from 0% PWM)
- 5 % PWM: 800 1/min or 0 1/min (Fan off, coming from 100% PWM)

3.2 Electrical Operating Data

Measurement conditions: Normal air density = 1,2 kg/m³; Temperature 23°C +/- 3°C; Motor axis horizontal; warm-up time before measuring 5 minutes (unless otherwise specified). In the intake and outlet area should not be any solid obstruction within 0,5 m.

- Δp = 0: corresp. to free air flow (see chapter aerodynamics)
- l: corresp. to arithm. mean current value

Name	Condition
PWM 0001	PWM: 95 %; f: 2 kHz

>90% PWM; f = 2 kHz or open control input wire

Features	Condition	Symbol	Values		
Voltage range		U	36 V		72 V
Nominal voltage		U _N		48 V	
Power consumption	Δp = 0	P	54 W	67 W	66,0 W
Tolerance	PWM 0010		+/- 10 %	+/- 10 %	+/- 10 %
Current consumption	Δp = 0	I	1.500 mA	1.400 mA	920 mA
Tolerance	PWM 0010		+/- 10 %	+/- 10 %	+/- 10 %
Speed	Δp = 0	n	6.700 1/min	7.000 1/min	7.000 1/min
Tolerance	PWM 0010		+/- 7,5 %	+/- 5 %	+/- 5 %

3.3 Electrical Interface - Output

Tacho type	/2 (open collector)
------------	---------------------

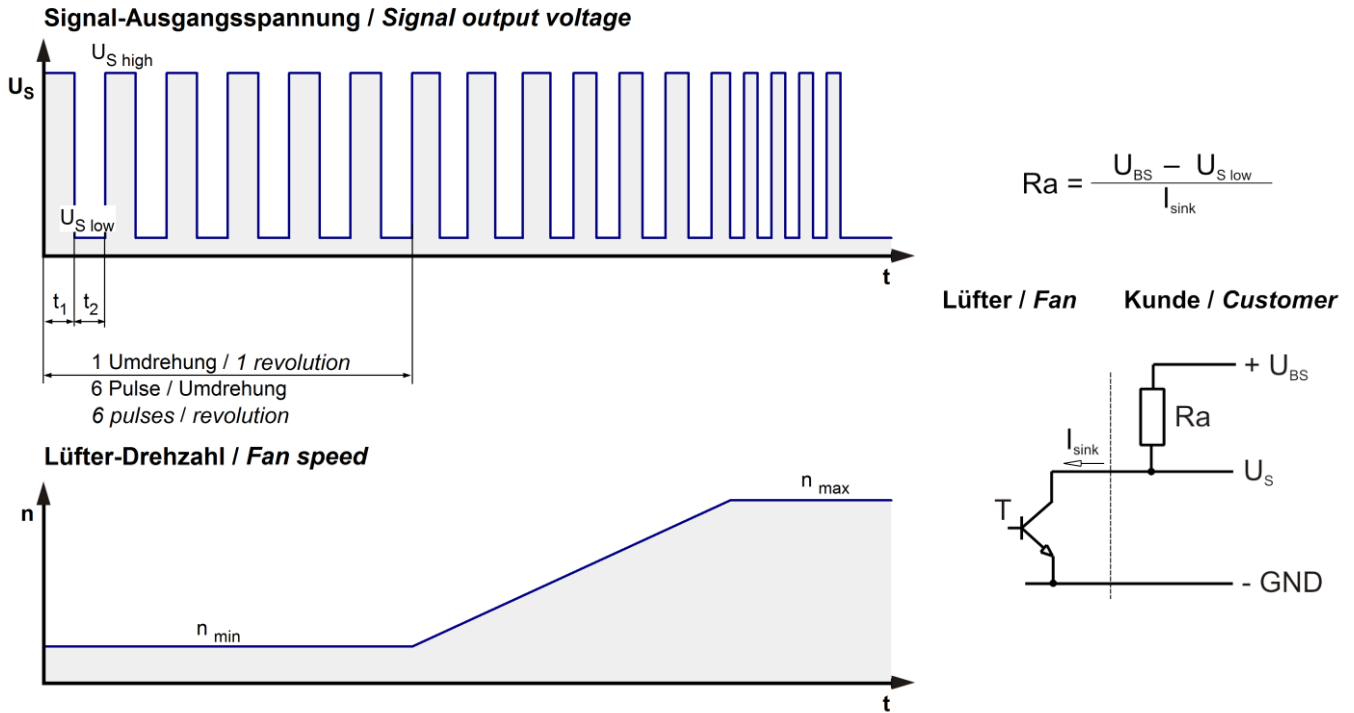

Features	Note	Values
Tacho operating voltage	U_{BS}	$\leq 60\ V$
Tacho signal Low	$U_{S\ low}$	$\leq 0,4\ V$
Tacho signal High	$U_{S\ high}$	$\leq 60\ V$
Maximum sink current	I_{sink}	$\leq 20\ mA$
External resistor	External resistor R_a from U_{BS} to U_S required. All voltages measured to GND.	
Tacho frequency	$(6 \times n) / 60$	700 Hz @ 7.000 1/min
Tacho isolated from motor	No	
Slew rate		$\Rightarrow 0,5\ V/\mu s$

n = revolutions per minute (1/min)

Please note:

At zero speed the tacho signal is at a static HIGH. It will be also HIGH when the fan is still spinning, but the speed control signal is set to zero speed already.
The tacho signal is only activated after the start-up is completed.

3.4 Electrical Features

Electronic function	Speed-Controlled	
Reversed polarity protection	P-CH FET	
Max. residual current at U_N	$I_F \leq 5\ mA$	

Locked rotor protection	Auto restart	
Locked rotor current at U_N	I_{block} approx. 2.000 mA	
Clock signal at locked rotor Extended Downtime	t_3 / t_4 typical: 2,5 s / 10 s t_5 : 40 s after 4 start-up tests	
Internal fuse	Littelfuse NANO2 > Very Fast-Acting > 451/453 Series 6,3A / 125V (Art.No.: 045106.3MRL)	
Voltage control *)	Fan turns on at $U_B > 32$ V or < 74 V Fan turns off at $U_B < 30$ V or > 78 V	

*) This fan has an undervoltage and overvoltage control circuit integrated which turns the motor off if the voltage is out of range.

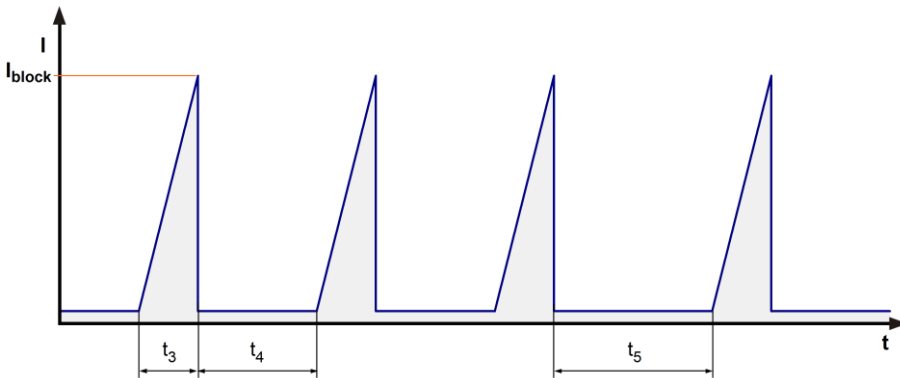

First locked rotor off time is reduced to 3 seconds.

This fan has a startup delay of 2 seconds after applying supply voltage.

Note to inrush current:

The internal electrolytic capacitors 2 x 220uF/75V have an inrush current limitation, the remaining peak depends on ceramic capacitor 2,2uF and EMI-filter.

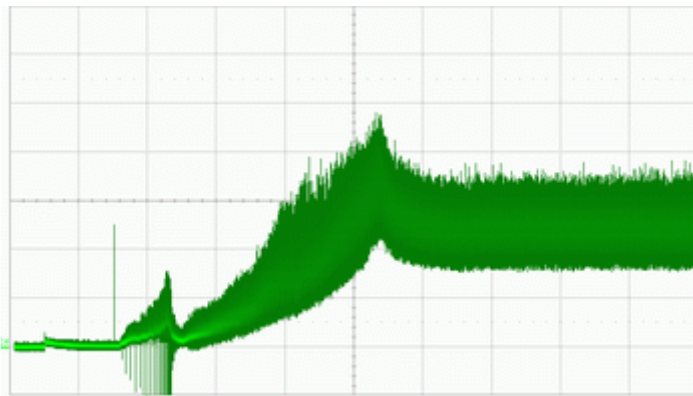

Start-up current at 48,0 V; I=500mA/Div, t=2s/Div

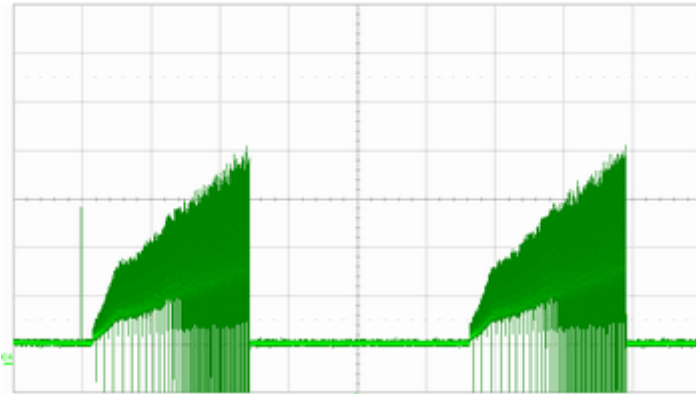

Locked rotor current at 48,0 V; I=500mA/Div, t=1s/Div



Running current at 48,0 V; 7.000 1/min; I=500mA/Div, t=2ms/Div

3.5 Aerodynamics

Measurement conditions:

Measured with a double chamber intake rig acc. to DIN EN ISO 5801.
 Normal air density = 1,2 kg/m³; Temperature 23°C +/- 3°C;
 In the intake and outlet area should not be any solid obstruction within 0,5 m. Motor shaft horizontal.
 The information is only valid under the specified test conditions and may be changed by the installation conditions. If there are deviations from the standard test conditions, the characteristic values must be checked under the installed conditions. Power consumption of the fan motor when operating at normal voltage is shown. Depending on the operating conditions of the application, the power input may be higher.

a.) Operation condition:

7.000 1/min at free air flow	PWM 95 %; f: 2 kHz		
Max. free-air flow ($\Delta p = 0 / \dot{V} = \text{max.}$)		680 m ³ /h	
Max. static pressure ($\Delta p = \text{max.} / \dot{V} = 0$)		860 Pa	

3.6 Sound Data

Measurement conditions: Sound pressure level: 1 meter distance between microphone and the air intake.
 Sound power level: Acc. to DIN 45635 part 38 (ISO 10302)
 Measured in a semianchoic chamber with a background noise level of $L_p(A) < 5 \text{ dB(A)}$
 For further measurement conditions see chapter aerodynamics.

a.) Operation condition:

7.000 1/min at free air flow	PWM 95 %; f: 2 kHz		
------------------------------	--------------------	--	--

Optimal operating point	670 m ³ /h @ 40 Pa		
Sound power level at the optimal operating point	7,9 bel(A)		
Sound pressure level at free air flow, measured in rubber bands	69,0 dB(A)		

4 Environment

4.1 General

Min. permitted ambient temperature TU min.	-20 °C		
Max. permitted ambient temperature TU max.	75 °C		
Min. permitted storage temperature TL min.	-40 °C		
Max. permitted storage temperature TL max.	80 °C		

4.2 Climatic Requirements

Humidity requirements	humid heat, constant; according to DIN EN 60068-2-78, 14 days		
Water exposure	None		
Dust requirements	None		
Salt fog requirements	None		

Permitted application area:

The product is intended for use in sheltered rooms with controlled temperature and controlled humidity. Directly exposure to water must be avoided.

Pollution degree 1 (according DIN EN 60664-1)

There is either no pollution or it occurs only dry, non-conductive pollution. The pollution has no negative impact.

Please require severity levels and specification parameters from the responsible development departments.

5 Safety

5.1 Electrical Safety

Dielectric strength DIN EN 60950 (VDE 0805) and DIN EN 60335 (VDE 0700) A.) Type test Measuring conditions: After 48h of storage at 95% R.H. and 25°C. No arcing or breakdown is allowed! All connections together to ground.	1000 VAC / 1 Min.	
B.) Routine test Measuring conditions: At indoor climate. No arcing or breakdown is allowed! All connections together to ground.	1700 VDC / 1 Sec.	
Isolation resistance Measuring conditions: After 48h of storage at 95% R.H. and 25°C measured with U=500 VDC for 1 min.	RI > 10 MOhm	
Clearance / creepage distance	1,0 mm / 1,5 mm	
Protection class	I	

5.2 Approval Tests

CE	EC Declaration of Conformity	No
EAC	Eurasian Conformity	Yes
UL	Underwriters Laboratories	Yes / UL507, Electric Fans
VDE	Association for Electrical, Electronic and Information Technologies	Yes / Approval acc. to EN 60950 (VDE 0805) - Information technology equipment
CSA	Canadian Standards Association	Yes / C22.2 No. 113 Fans and Ventilators
CCC	China Compulsory Certification	Yes / GB 12350 Safety Requirements for small Power Motors

The approval tests are observed to:

U approval max.: 72,0 V @ TU approval max.: 75,0 °C

6 Reliability

6.1 General

Life expectancy L10 at TU = 40 °C	62.500 h	
Life expectancy L10 at TU max.	30.000 h	
Life expectancy L10 acc. to IPC 9591 at TU = 40 °C	105.000 h	

Copies of this document, and drawings thereof, are not to be made or manufactured or to be used for any other purpose without the express written permission of the manufacturer. All rights are reserved in the event of the use of a part of the reproduction of this document or design.

Zeichnung nach DIN ISO 9000-Bestimmungen
 Drawing according to DIN ISO 9000

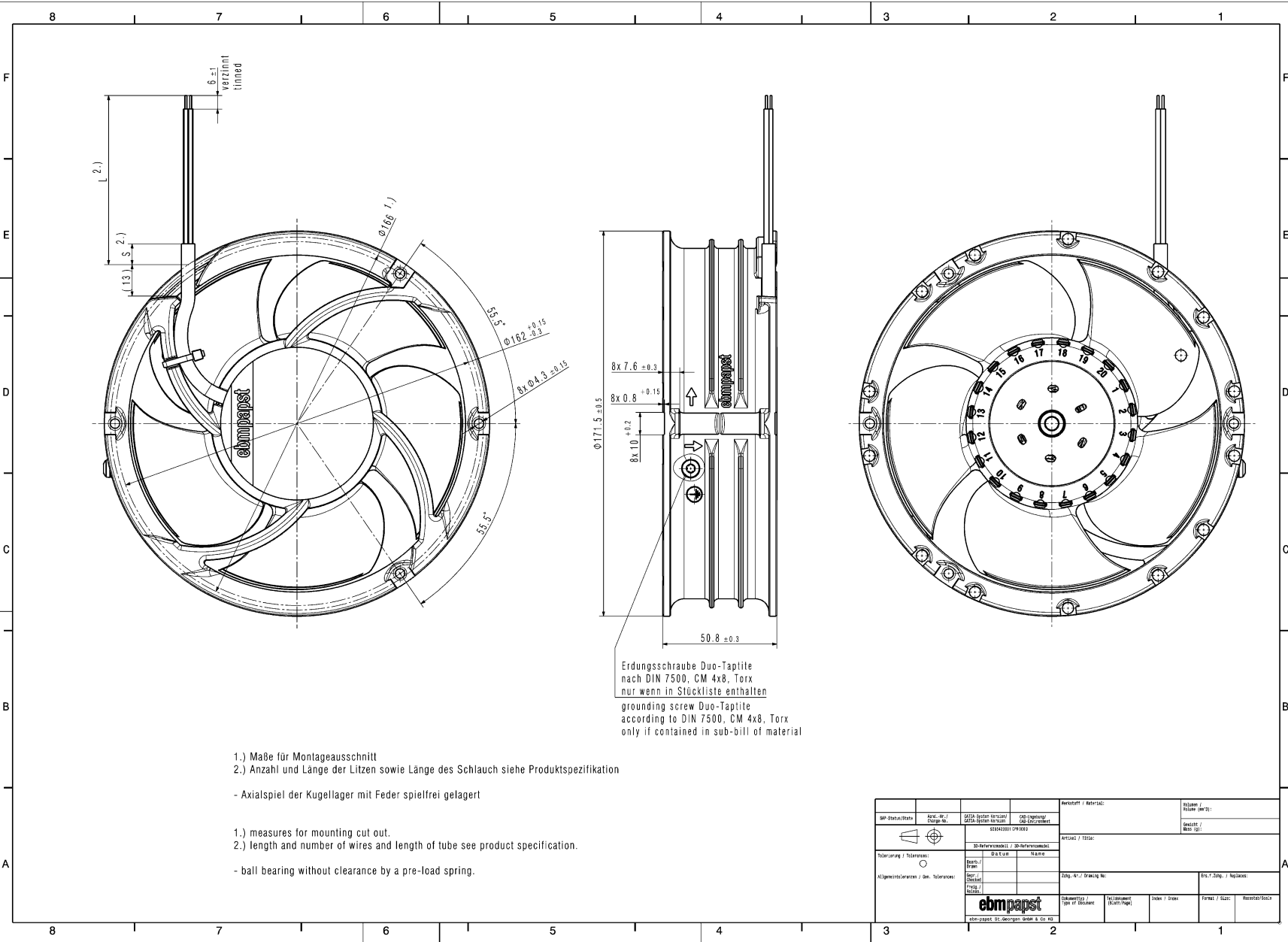

Erdungsschraube Duo-Taptilite
 nach DIN 7500, CM 4x8, Torx
 nur wenn in Stückliste enthalten
 grounding screw Duo-Taptilite
 according to DIN 7500, CM 4x8, Torx
 only if contained in sub-bill of material

- 1.) Maße für Montageausschnitt
 2.) Anzahl und Länge der Litzen sowie Länge des Schlauch siehe Produktspezifikation
 - Axialspiel der Kugellager mit Feder spielfrei gelagert
 - ball bearing without clearance by a pre-load spring.
- 1.) measures for mounting cut out.
 2.) length and number of wires and length of tube see product specification.

SAP Status/Status Zeichnungs- Change No.		3D-Modell (3D-Modell) 3D-Modell (3D-Modell)		Produkt / Material: 62844001 0P000		Position / Pos. (des 3):	
3D-Referenzcode / 3D-Referenzcode 62844001 0P000		Artikel / Title:		Gewicht / Mass (kg):		Anzahl / Qty:	
Tolerierung / Tolerances: Maß / Dimension: H7/k6		3D-Referenzcode / 3D-Referenzcode 62844001 0P000		2D-Zug- / Drawing No.:		Ein-/Zug- / In-/Out:	
Allgemeine/Gen- / Gen- tolerances: H7/k6		ebmpapst 3D-Modell (3D-Modell)		Dokument / Type of Document:		Stück / Qty:	
3D-Modell (3D-Modell)		3D-Modell (3D-Modell)		Form / Form:		Material / Material:	