



Electronic Roller Shutter Belt Winder **superrollo GW180 / GW185**

Translation of the Original Operating and Assembly Manual.....1



Item No.:

superrollo GW180

SR10180

superrollo GW185 *

SR10185

* Mini belt



Dear Customer,

With your purchase of a roller shutter belt winder **superrollo GW180/GW185**, you have chosen a quality product manufactured by superrollo. Thank you for the trust you have placed in us.

i	Dear Customer,	2	13.	End point adjustment.....	26
1.	These instructions.....	4	14.	Manual operation.....	28
1.1	Application of this manual	4	15.	Setting the summer/winter time.....	29
2.	Hazard symbols	4	16.	Automatic timer; brief description	30
2.1	Levels of danger and signal words	5	16.1	Configuring an opening and closing time	30
2.2	Symbols and depictions used	5	16.2	Switching the automatic timer on / off.....	31
2.3	Technical Term - Definition.....	6	17.	Erase all settings, software reset	32
3.	Included in delivery	7	18.	Removing the superrollo GW180 / GW185 (e.g. in the event of a move)	33
4.	Overview superrollo GW180 / GW185	8	19.	Removing the belt in the event of unit failure	35
4.1	Operating Buttons and Indicator Light.....	9	20.	What to do if... ?	36
5.	Functional description	10	21.	Information about maintenance and care of your equipment.....	38
5.1	Description of the safety functions.....	11	22.	Tractive force diagram.....	39
6.	Technical Specifications	12	23.	CE Mark and EC Declaration of Conformity.....	40
6.1	Dimensions	13	24.	Warranty conditions	41
6.2	Permissible roller shutter belts	14			
7.	Safety instructions	15			
7.1	Intended use.....	16			
7.2	Improper use	17			
8.	Safety instructions for the installation.....	18			
8.1	You will require the following tools	18			
9.	Preparation for installation	19			
10.	Mounting the wall bracket	21			
11.	Drawing in and fastening the belt	23			
12.	Mounting the superrollo GW180 / GW185.....	25			

i 1. These instructions...

...describes how to install, connect the electrical system and operate your roller shutter belt winder superrollo GW180/GW185.

i 1.1 Application of this manual

- ◆ Before you begin, please read this manual through completely and follow all the safety instructions.
- ◆ This manual is a component of the product. Please store it in an easily accessible place.
- ◆ When passing the superrollo GW180/GW185 on to a third party, this manual must be passed on as well.
- ◆ Damage resulting from non-compliance with these instructions and safety instructions will void the guarantee. We shall assume no liability for any consequential damage.

i 2. Hazard symbols

The following hazard symbols are used in this instruction manual:



Danger of fatal electric shock



Danger area / dangerous situation

2.1 Levels of danger and signal words

DANGER!

This hazard will result in serious injury or death if not avoided.

WARNING!

This hazard may result in serious injury or death if not avoided.

CAUTION!

This hazard may result in minor or moderate injury if not avoided.

ATTENTION!

This hazard may lead to property damage.

2.2 Symbols and depictions used

Depiction	Description
1.	Steps to be taken
2.	
◆	Itemisation
(1) or a)	List



Please read the respective manual



further useful information

DIN EN 13659

"Shutters and external Venetian blinds - Performance requirements including safety."

- ◆ This standard determines the performance requirements that externally attached shutters and blinds must fulfil. It also contains significant hazards with regard to the design, transportation, installation, operation and maintenance of these shutters and blinds.

Blinds

- ◆ Roller shutters

Obstacle detection

- ◆ If the roller shutters hit an obstacle in the DOWN (▼) direction, the superrollo GW180/GW185 is switched off, see page 11.

Overload cut-off

- ◆ If the drive jams in the UP (▲) direction (for example, due to ice), the superrollo GW180/GW185 is switched off, see page 11.

End points

- ◆ An end point is defined and set for each running direction of the roller shutter. Once this point has been reached, the superrollo GW180/GW185 switches off and the roller shutter stops.

Running Time Limit - Transient Operation (KB)

- ◆ The roller shutter belt winder superrollo GW180/GW185 is not designed for continuous operation. Transient operation defines the maximum permissible running time, see page 12 /15.

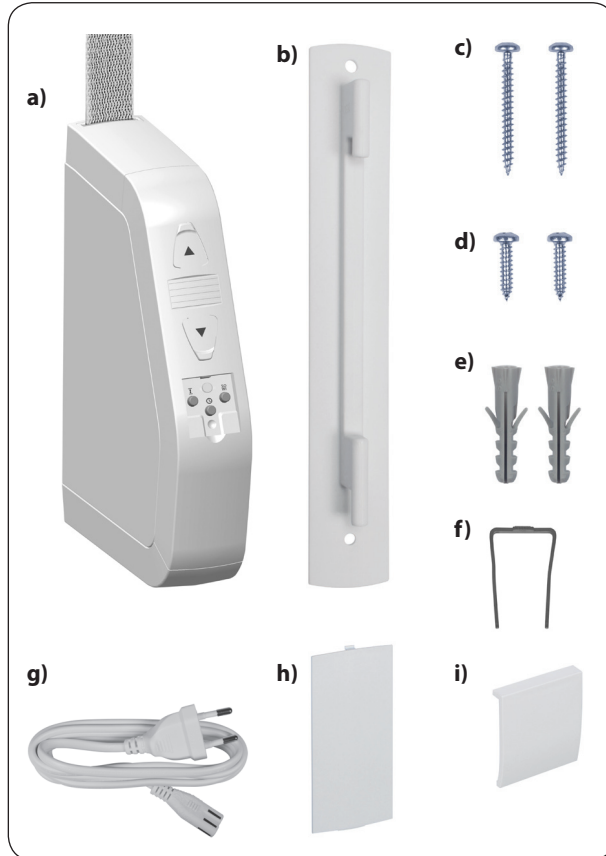

Included in delivery

- a) 1 x superrollo GW180/GW185
- b) 1 x Wall bracket
- c) 2 x Assembly screws (4 x 40 mm)
- d) 2 x Assembly screws (4.2 x 19 mm)
- e) 2 x Wall plugs (S6 x 30 mm)
- f) 1 x Disengaging bracket
- g) 1 x Connecting cable with Euro plug
- h) 1 x Reel compartment cover
- i) 1 x Cover plate
- j) 1 x Instruction manual (not illustrated)

After unpacking please check and compare...

the contents of the package with the above specified.

Check the details on the type plate

Check that the voltage / frequency on the type plate corresponds to the local mains conditions.







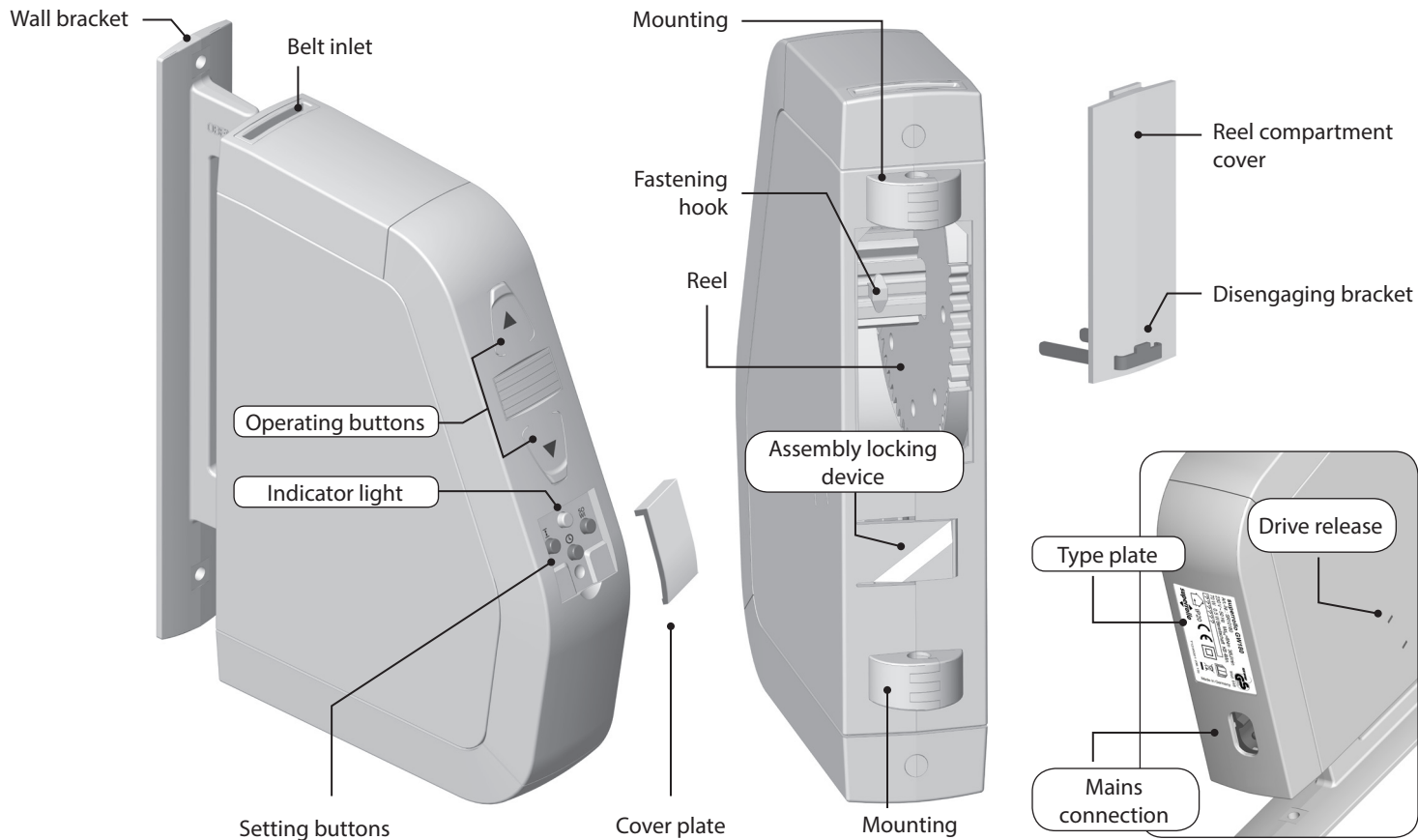

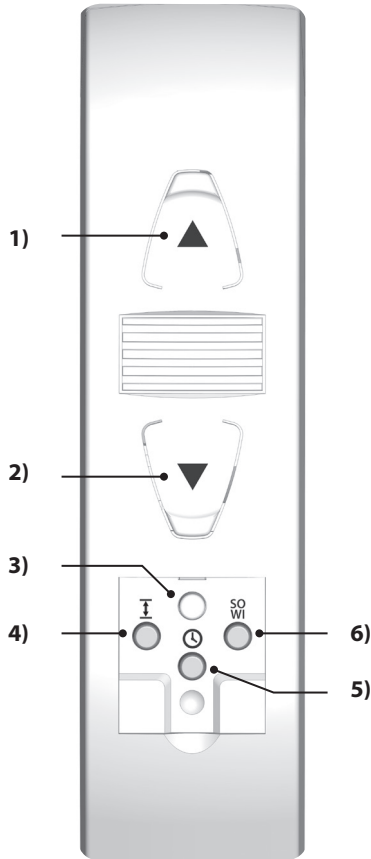
4. Overview superrollo GW180/GW185

EN





Pos.	Symbol	Description
1)		Up / Stop button <i>The roller shutter travels upwards.</i>
2)		Down / Stop button <i>The roller shutter travels downwards.</i>
3)		Indicator Light - Status Display
	red	<i>flashes briefly</i> <i>Return signal when pressing the timer button or the SU/WI button.</i>
		<i>continuous light</i> <i>Status display of the respective function (10 seconds).</i>
		<i>flashes briefly</i> ◆ <i>During the setting process or when resetting.</i>
		◆ <i>After a power failure.</i>
4)		Set button <i>Setting the end points</i>
5)		Timer button ◆ <i>Setting both switching times.</i> ◆ <i>Switching the automatic timer function on/off.</i>
6)		SU/WI button <i>Switching between summer and winter time.</i>

The superollo GW180/GW185 is an electric roller shutter belt winder designed for use inside. The unit is installed as a surface-mounted device. The power supply is provided via the enclosed connecting cable with a mains plug and a small appliances plug.

Features and control options:

- ◆ Manual operation
- ◆ Automatic mode, with a separate switching time for UP (▲) and DOWN (▼)
- ◆ Switching automatic mode on/off
- ◆ Summer/winter time - changeover
- ◆ End point setting
- ◆ Permanent storage of the settings
- ◆ Obstacle detection
- ◆ Overload cut-off
- ◆ Resetting to the default factory settings (Reset)

Obstacle detection

The movement of the belt is monitored. If the roller shutters hit an obstacle in the DOWN (▼) direction, the belt will stop moving and the superrollo GW180/GW185 is switched off.



Once the system has switched off, it is not possible to directly operate the drive in the same direction.

- ◆ First, run the belt winder back in the opposite direction and remove any possible obstacle.
- ◆ Then it is possible to operate the drive in the original direction again.



There is a risk of injury if the obstacle detection is not working.

- ◆ The belt must be wound on as evenly as possible to ensure safe and correct functioning of the obstacle detection function.
- ◆ Please ensure that the belt winds as straight and evenly as possible into the device during its subsequent cycle after the obstacle detection system has triggered.

Overload cut-off

The superrollo GW180 / GW185 is equipped with an overload cut-off system.

If the drive jams in the UP (▲) direction (for example, due to ice), the superrollo GW180 / GW185 is switched off.

- ◆ First, remove the cause of the overload.
- ◆ Then the superrollo GW180 / GW185 is fully operational again in both directions.

Power supply

Supply voltage:	230 V ~ / 50 Hz
Nominal power:	70 W
Consumption:	Standby: < 0.5 W

Mechanical capacity

Nominal torque:	8 Nm
Maximum speed:	36 rpm
Maximum tractive force:	30 kg, see page 39 / Tractive force diagram
End tractive force:	13 kg

Operating conditions

Transient operation (KB):	4 minutes (maximum running time)
Protection class:	II
Protection type:	IP20 (only for use in dry rooms)
Number of switching times:	2 (up and down)
Mains connecting cable:	2 x 0.75 mm ² (H03VVH2-F)
Permissible ambient temperature:	0 °C to +40°C
Sound pressure level (LpA):	≤ 70 dB(A)

Conduct in the event of power failure

The indicator light flashes in the event of a power failure.

The flashing is switched off by pressing the UP (▲) or DOWN (▼) button.

Data retention following a power failure

The configured switching times are retained after a power failure. As soon as the power supply is restored, the opening and closing times will be executed again. However, the times will be offset by the duration of the power failure.

Example:

- ◆ Power failure from 19:30 - 19:45 hours.
- ◆ The closing time was previously set to 19:30 hours.
- ◆ The roller shutters will close at 19:45 hours due to the duration of the power failure.



6.1 Dimensions

EN

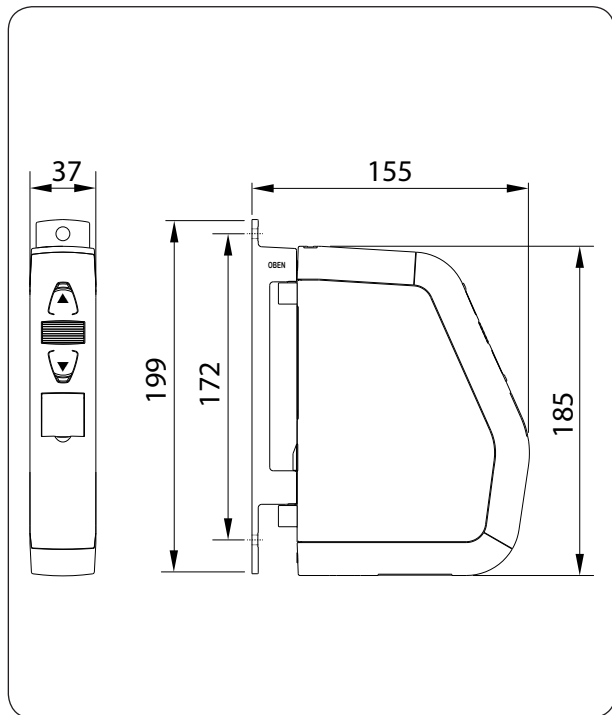

All dimensions in mm

superrollo GW180 / GW185
Item no.: SR10180 / SR10185

⚠ ATTENTION!

The superrollo GW180 / GW185 may be damaged if excessively long belts are used.

Only use belts of the permissible lengths.



The specifications are intended for guidance only and apply to an ideal installation situation.

The actual values may vary due to local conditions.

Table 1: Permissible roller shutter belts

superollo: Item No.:		GW185 (Mini Belt) SR10185	GW180 SR10180
Belt width:	Belt thickness	Maximum belt length	
15 mm (Mini-belt)	1.0 mm	5 m	
23 mm (Standard belt)	1.0 mm		5 m
	1.3 mm		4 m
	1.5 mm		3.4 m

Table 2: Permissible shutter surface area (m²)

Roller shutter type:	Weight/m ²	Permissible shutter surface area (m ²)	
Plastic roller shutters	(4.5 kg/m ²)	Approx. 5 m ²	Approx. 5 m ²
Aluminium and wooden roller shutters	(10.0 kg/m ²)	Approx. 2.5 m ²	Approx. 2.5 m ²



The use of defective equipment can lead to personal injury and damage to property (electric shocks, short circuiting).

- ◆ Never use defective or damaged equipment.
- ◆ Check the superrollo GW180 / GW185 and the provided mains cable beforehand for damage.
- ◆ Should you discover damage to the equipment, please consult our customer service department (see page 44).



Incorrect use leads to an increased risk of injury.

- ◆ Train all personnel to use the superrollo GW180 / GW185 safely.
- ◆ This device may be used by children from 8 years of age upwards as well as by persons with reduced physical, sensory or mental capacities or with lack of experience and knowledge if they are supervised or have been instructed on how to use the device safely and if they understand what dangers may result from this.

- ◆ Children must not play with the device. Cleaning and user maintenance may not be carried out by children without supervision.
- ◆ Watch the moving roller shutters whilst carrying out the settings and during normal operation, and keep other people away from the area to avoid injury in the event the shutters suddenly slip.
- ◆ Carry out all cleaning work on the roller shutters whilst the device is disconnected from the mains power.

The mains socket and plug must be easily accessible at all times.



7. Safety instructions

EN



Exceeding the maximum permissible running time (KB) may overload and damage the superrollo GW180/GW185.

- ◆ The maximum permissible running time for a cycle may not be exceeded when the equipment is in operation. For this reason, the superrollo GW180/GW185 has an **automatic running time limit (KB)** of four minutes.
- ◆ If the running time limit is triggered, then the superrollo GW180/GW185 must be left for at least 12 minutes to cool down. During this period, the indicator light flashes rapidly. Full operational availability is re-established after approx. one hour.

According to DIN EN 13659, it is necessary to determine that the movement conditions for the shutters are maintained in accordance with EN 12045.

- ◆ The displacement must be of at least 40 mm on the lower edge in the rolled-out position with a force of 150 N in the upwards direction.
- ◆ In doing so, it must be ensured that the extending speed of the shutters for the final 0.4 m is less than 0.15 m/s.



7.1 Intended use

Only use the superrollo GW180/GW185 for opening and closing flat roller shutters with a permissible belt.



Mechanical locks of any kind are not suitable for automated operation with this device.

Only use the manufacturer's original spare parts.

- ◆ By doing so, you avoid risk of malfunctions and damage to your superrollo GW180/GW185.
- ◆ As the manufacturer, we provide no guarantee for the use of third-party components and accept no liability for consequential damage resulting from such.
- ◆ All repairs to the superrollo GW180/GW185 must be undertaken by authorised customer service personnel.

Operating conditions

- ◆ Only operate the superrollo GW180/GW185 in dry rooms.
- ◆ An easily accessible 230 V/50 Hz mains socket must be available at the installation site.
- ◆ The roller shutters must run up and down smoothly and should not stick.
- ◆ The mounting surface for the superrollo GW180/GW185 must be flat.

7.2 Improper use

Using the superrollo GW180/GW185 for purposes other than previously mentioned is impermissible.



There is a risk to life caused through short circuiting and electric shocks if the superrollo GW180/GW185 is used outside.

- ◆ Never install or operate the superrollo GW180/GW185 outside.

i 8. Safety instructions for the installation



Poor routing of the belt can cause the belt to fail and leads to unnecessary loads on the superrollo GW180 / GW185.

- ◆ Install the belt winder so that the belt runs as straight as possible into the device, in order to avoid unnecessary friction and wear.



Incorrect installation can lead to property damage.

- ◆ Strong forces are exerted during operation of the system which require secure installation on a firm base.

i 8.1 You will require the following tools

- ◆ Screwdriver (cross recessed head)
- ◆ Scissors
- ◆ Carpenter's gauge or measuring tape
- ◆ Pen
- ◆ A drilling machine and a 6 mm masonry drill, if new mounting holes need to be drilled.

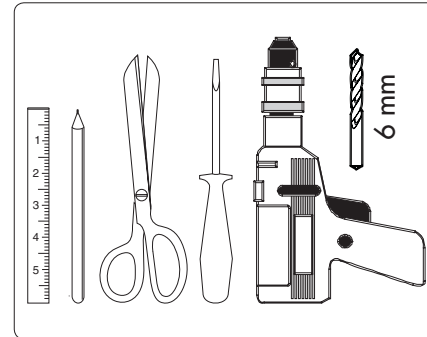

1. Take measurements. Check that there is sufficient space for the superrollo GW180/GW185.
2. Remove the old belt winder, if you are carrying out a conversion to an existing roller shutter system.
 - 2.1 Let the roller shutter move fully down, until the slats are completely closed.
 - 2.2 Remove the old belt winder and unreel the belt.

⚠ CAUTION!

There is a risk of injury from the pre-tensioned springs on the old belt winder.

- ◆ The spring unit of the old belt winder may suddenly recoil when it is removed.
- ◆ Hold the spring unit firmly when loosening the belt and allow it to recoil slowly until the spring unit has completely unwound.

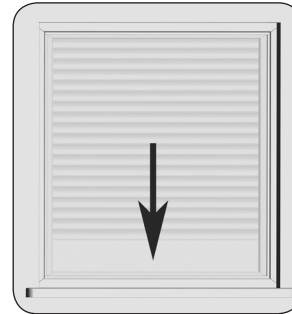

3. Prepare the belt.

- 3.1 Cut the belt off approx. 20 cm under the mounting position.
- 3.2 Fold the end of the belt over by approx. 2 cm and cut a short slit in the centre. This enables you to subsequently hook the belt onto the reel.

Recommendation

The belt must run as straight and freely as possible. For stiff roller shutters, mount a deflection roller on the belt box. This helps to prevent unnecessary friction and wear to the belt.

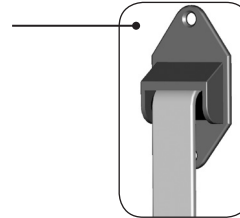
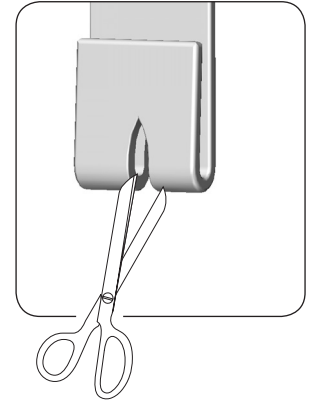
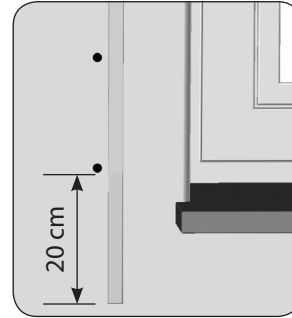

Note for mounting on window frames, etc.



Weak window frames may break.

- ◆ When mounting on window frames, please check their structure and load capacity. Especially when mounting onto designs made of synthetic materials, the fastening screws must be screwed tight and must not loosen during operation.
- ◆ If required, ask your window manufacturer before fastening the belt winder onto a window frame made of synthetic materials.

1. Use the provided mounting holes.

Two mounting holes are required to fasten the belt winder. Generally, it is possible to use the existing mounting holes of the old belt winder to screw the wall brackets in place.

2. Draw on the new mounting holes.

Hold the wall bracket onto the desired installation position and draw on both mounting holes if new mounting holes need to be drilled.

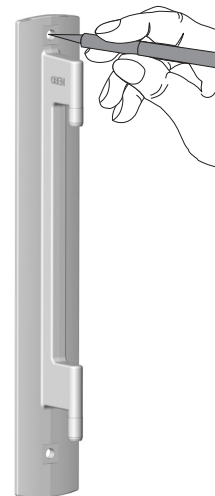

3. Drill mounting holes (only required for wall mounting).

Drill the mounting holes with a 6 mm masonry drilling machine and place the provided wall plugs into the drilled holes.

10. Mounting the wall bracket



The letterings "TOP and OBEN" on the wall bracket indicates the correct mounting position.

4. Screw on the wall bracket with the screws provided and ensure that the right side is facing upwards (OBEN/TOP).



Use the correct type of screw depending on the mounting surface, see the 'included in delivery' section on page 7.

- ◆ Wall mounting = 4 x 40 mm
- ◆ Mounting onto window frame = 4.2 x 19 mm

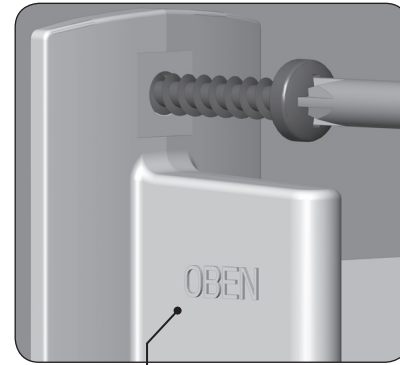
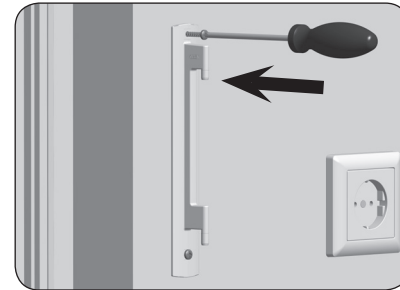

Indication of the correct mounting position on the wall bracket.

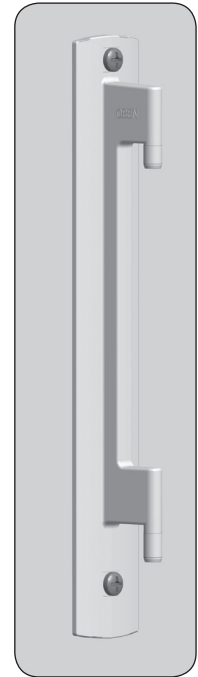

Correct mounting of the wall bracket.

11. Drawing in and fastening the belt

1. First, plug in the small appliances plug into the mains connection of the superrollo GW180/GW185 and subsequently the mains plug into the socket.

CAUTION!

There is a risk of injury from the reel.

Never reach into the reel compartment when the motor is running.

2.  Press the Up button until the Fastening hook are easily accessible in the reel compartment.



As no end points have been set yet, the drive will stop as soon as you release the button.

3. Remove the mains plug again from the socket.

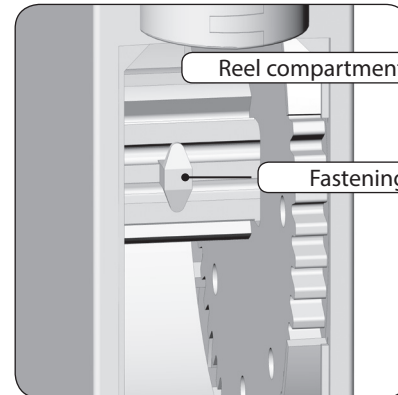
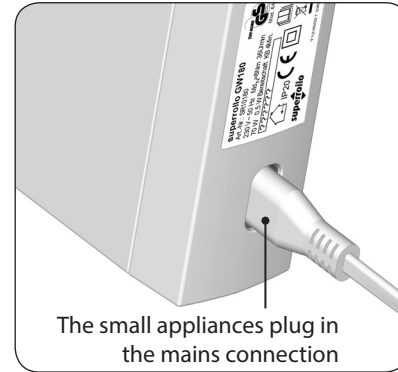

4. Next, draw-in the belt into the superrollo GW180/GW185 from the top.
Feed the belt into the device, as shown in the image, and slide it over the Fastening hook from below.
5. Re-insert the mains plug into the socket.
6.  Press the up button until the belt has fully wound once around the reel.
7. Pull the belt tight when winding, so that the deflection roller turns at the same time.
8. Remove the mains plug again from the socket.
9. Finally, place the provided reel compartment cover onto the reel compartment.

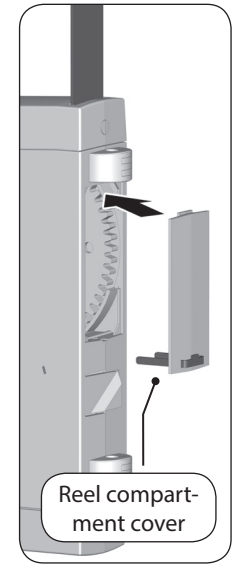
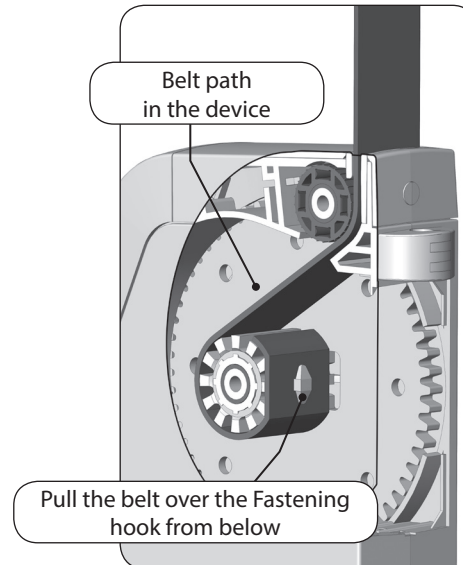
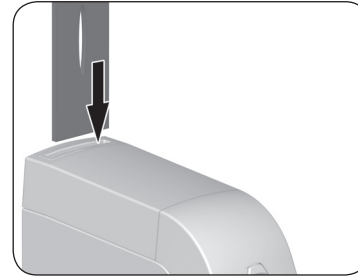

1. Slide the superrollo GW180 / GW185 onto the wall bracket from below until it engages.
Otherwise, the superrollo GW180 / GW185 may fall off again.

⚠ WARNING!

A damaged connecting cable may cause a short circuit.

Ensure that the connecting cable is not pinched or damaged during the mounting process.

2. Re-insert the mains plug into the 230 V / 50 Hz socket.



Leave the bottom cover plate of the setting buttons open until all settings have been carried out.

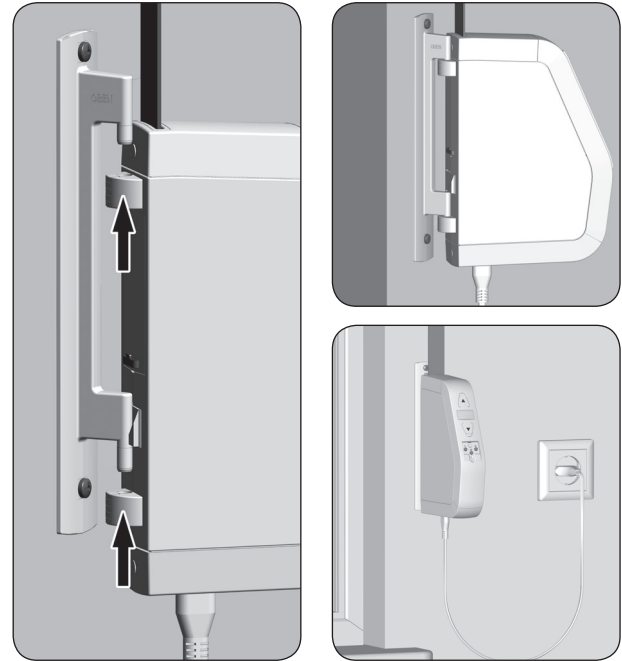



13. End point adjustment

Additional information about configuring the end points

The end points must be configured for the roller shutters to stop at the desired upper and lower positions.



It is imperative that both end points are configured, otherwise malfunctions may occur.





If the superrollo GW180/GW185 is operated without an end point setting, the drive will continue to run as long as one of the two control buttons is actuated.

The automatic functions remain blocked until the end point setting is configured.

Set the upper end point

1.  +  Simultaneously press and hold the buttons.
The roller shutter travels up.

- 1.1 Tighten the belt slightly, until it is tensioned by the weight of the roller shutters.

2.  +  Release the buttons, as soon as the roller shutter reaches the desired position for the upper end point.
The roller shutters stop and the upper end point is stored.

ATTENTION!



Setting the wrong upper end point may lead to overload or damage the superrollo GW180/GW185 or the drive.



- ◆ Do not set the upper end point right up to the limit stop.
- ◆ Release the button promptly and never allow it to extend beyond the respective end point.



13. End point adjustment

Set the lower end point

3.  +  Simultaneously press and hold the buttons.
The roller shutter travels down.

4.  +  Release the buttons, as soon as the roller shutter reaches the desired position for the lower end point.
The roller shutters stop and the lower end point is stored.



Please ensure that the belt is not excessively slack when reaching the lower end point.

Changing or correcting the end points

5. Move the roller shutters to the centre position and configure the respective end point again.







After a period of time it may be necessary to reconfigure the end points as the belt may elongate during the process of operation.



14. Manual operation

Manual operation is possible in any of the modes and has priority over the programmed automatic functions.

-  Open the roller shutters.
By briefly pressing the button, the roller shutters will move to the upper end point.
-  or  Stop the shutters in the interim.
-  Close the roller shutters.
By briefly pressing the button, the roller shutters will move to the lower end point.

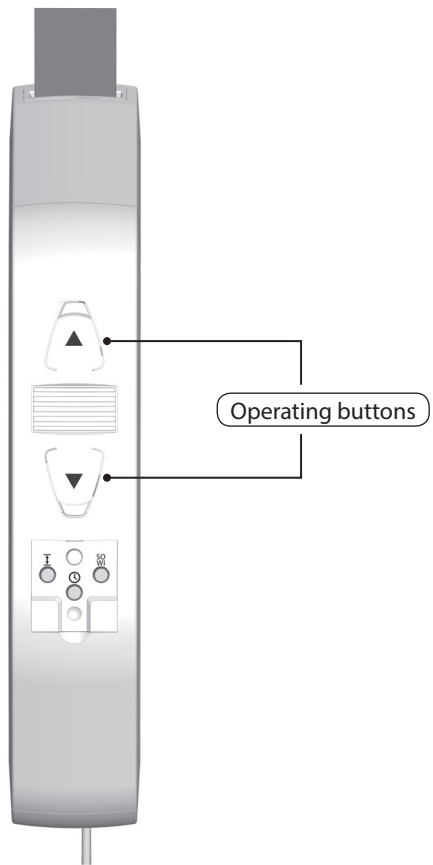



15. Setting the summer/winter time

The superrollo GW180 / GW185 is equipped with a summer/winter changeover function. With this, the internal timer of the belt can be set to the summer or winter time.

Call up the current time status

1.  Briefly press the SU/WI button.
2. Pay attention to the indicator light.

The indicator light flashes briefly to confirm that the SU/WI button has been pressed. The status of the summer/winter setting will then be displayed.

-  ON (10 seconds) = summer time
-  OFF = winter time



The superrollo GW180 / GW185 is delivered from the factory with the summer time.

Setting the summer/winter time

1.  Press the SU/WI button for approx. 1 second.
2. The respective current time status will be changed over.



16. Automatic timer; brief description

The same switching times every day of the week.

You can set an opening and closing time for your super-rollo GW180/GW185 which will apply to all days of the week. Once this time is reached, the roller shutters will open or close automatically.

Changing the switching times

You can change the switching time settings at any time. Please note that each new setting deletes the previous setting.



In order to set the switching times, you must carry out this step once at the time that the roller shutters are to open or close.

For example, carry out the step at 8:00 o'clock in the morning if you want the roller shutters to open at 8:00 AM every day.

- ◆ You must set at least one switching time, in order to activate the automatic timer.



16.1 Configuring an opening and closing time

Configure an opening time (▲) (e.g. at 8:00 AM)

1. + Simultaneously briefly press the buttons.

2. The indicator light flashes and the roller shutter travels upwards. The automatic timer is now activated.

Your roller shutters will open automatically every day at 8:00 AM.



16.1 Configuring an opening and closing time

Configure a closing time (▼)
(e.g. at 20:30 hours)

1.  + 

Simultaneously briefly press the buttons.

2. 

The indicator light flashes and the roller shutter travels downwards. The automatic timer is now activated.

Your roller shutters will close automatically every day at 20:30.



16.2 Switching the automatic timer on / off

If required, the automatic timer can be switched on or off at any time.

1.  Press and hold the timer button for approx. 1 second.

2. Pay attention to the indicator light.
The indicator light flashes briefly to confirm that the timer button has been pressed. The status of the automatic timer will then be displayed.



OFF

Automatic timer OFF

The previously configured switching times are stored.



ON (10 seconds)

Automatic timer ON



Flashing

After power failure, if at least one switching time was previously been configured.



In the event of power failure, the switching times will be extended by the duration of the power failure, and therefore may require reconfiguration.

If necessary, you can erase all of your settings and return the superrollo GW180/GW185 system to its original factory settings.

1. Remove the cover plate from the setting buttons.



2.  +  +  Simultaneously press and hold the buttons for 4 seconds.

3.  The indicator light flashes rapidly.







4. Release the buttons, subsequently all of the settings will be deleted.
 - ◆ End points
 - ◆ Timer periods

5. The indicator light will go off once the button is released.



18. Removing the superrollo GW180 / GW185 (e.g. in the event of a move)

EN

1. Remove the cover plate from the setting buttons.
2.  +  +  Erase all settings.
Simultaneously press and hold the buttons for 4 seconds.
3.  Fully close the roller shutters.
4.  Continue to press and hold the down button.
5. In doing so, pull out the belt as far as possible from the top of the superrollo GW180 / GW185.
6.  Remove the mains plug from the socket and the small appliances plug from the superrollo GW180 / GW185.
7. Press the assembly locking device on the back part and remove the superrollo GW180 / GW185 from the wall bracket by pulling it downwards.

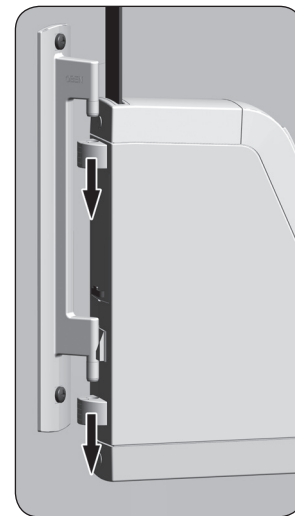
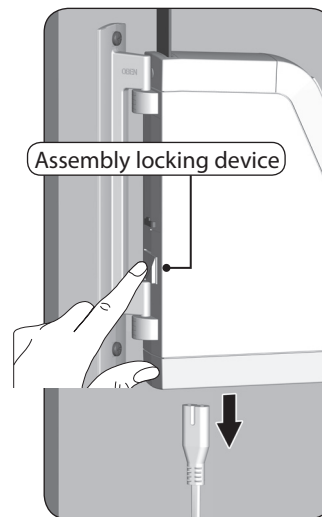
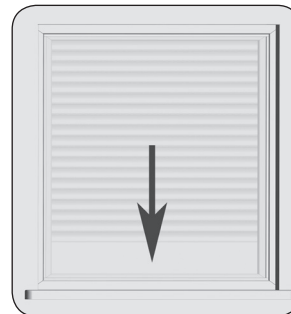

8. Remove the reel compartment cover and check the position of the fastening hook.
9. If necessary, move the fastening hook into an easily accessible position.
- 9.1 For this, plug the mains cable into the superrollo GW180 / GW185 and into the socket.

⚠ CAUTION!

There is a risk of injury from the reel.

- ◆ Never reach into the reel compartment when the motor is running.
- ◆ Always remove the mains plug before touching the reel compartment.

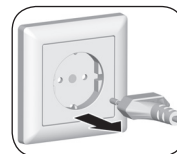
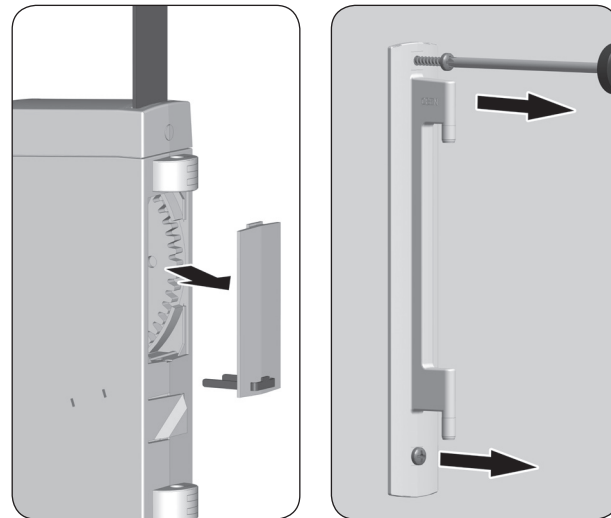

10. Finally, remove the mains plug again from the socket.
11. Release the belt from the fastening hook and pull it out completely from the front of the superrollo GW180 / GW185.
12. Finally, unscrew the wall bracket.

In the event that the superrollo GW180/GW185 unit fails and the motor no longer runs, you can use the disengaging bracket provided in order to fully remove the belt from the belt winder unit, without the need for cutting it.

WARNING!

There is a risk of injury as the roller shutters may slam shut or fall in an uncontrolled manner.

- ◆ Secure the roller shutters from falling, for example, by laying something underneath it.
- ◆ Hold on to the belt tightly to stop the roller shutters from slamming shut or falling in an uncontrolled manner.
- ◆ Get a second person to help you unlatch the unit.

1.



Remove the mains plug from the socket.

2.

Turn the superrollo GW180/GW185 completely to the side.

3.

Release the drive with the help of the supplied disengaging bracket. A small amount of resistance must be overcome when pressing.

4. Maintain pressure on the disengaging bracket and pull the belt out of the superrollo GW180/GW185 as far as possible.

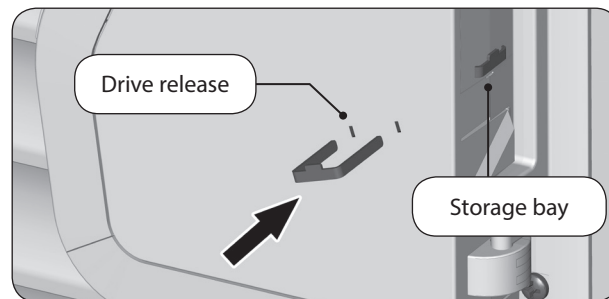

5. Remove the reel compartment cover. Release the belt from the fastening hook and pull it out completely from the superrollo GW180/GW185.
6. Press the assembly locking device on the back part and remove the superrollo GW180/GW185 from the wall bracket by pulling it downwards.
7. Place the disengaging bracket back into the storage compartment.

Fault	Possible cause / solution
... the superrollo GW180/GW185 indicates no functions?	Check the power supply incl. connecting cable and plug.
... the superrollo GW180/GW185 fails to react at the configured switching time?	a) There may have been a power failure. Reconfigure the switching times, see page 30.
	b) The end points may not be configured. Reconfigure the end points, see page 26.
... the indicator light (LED) is flashing?	There may have been a power failure. Reconfigure the switching times, see page 30.
... the roller shutters no longer stop at the configured end points?	The end points may be displaced due to elongation of the belt. Re-adjust the end points, see page 26.
... the roller shutters stop as soon as the operating button is released?	The end points are not configured. Configure the end points, see page 26.
... the superrollo GW180/GW185 rotates in the wrong direction?	Possibly the belt is wrapped around the reel incorrectly, see page 23.
... the roller shutters stop suddenly during upward travel?	a) The drive may be jammed, for example, due to the roller shutters freezing up or other obstacles.
	b) The roller shutters may not be running sufficiently smoothly. Check the roller shutters and roller shutter guides.
	d) The roller shutters may be too heavy. The maximum tractive force of the belt winder has been exceeded, see page 39.

Fault	Possible cause / solution
... the roller shutters stop during downward travel?	<p>a) The roller shutters may have hit an obstacle. Move the roller shutters back up and remove the obstacle.</p> <p>b) Slats have shifted out of alignment. If possible, move the roller shutters back up and realign the slats.</p> <p>c) The roller shutters scrape against the window frame inside the roller shutter box due to the lack of a pinch roller or insulation material may have come free and is jamming the roller shutters. Open the roller shutter box and rectify the fault. Lubricate any stiff areas with gliding wax if necessary.</p> <p>d) The roller shutters are too light. Increase the weight of the roller shutters by, for example, adding a piece of flat steel to the bottom slat.</p>
... the indicator light flashes and the superrollo GW180/GW185 fails to operate in either direction?	<p>The maximum running time of the drive has been exceeded, see page 12/15. The motor is too hot. The belt winder will be fully operational again in approx. 1 hour.</p>
... the superrollo GW180/GW185 fails to react properly either manually or automatically?	<p>The superrollo GW180/GW185 is no longer ready for operation. Carry out a software reset in accordance with the instructions on page 32 and test the superrollo GW180/GW185 using the default factory settings.</p>

Maintenance

 **CAUTION!**

A lack of maintenance can lead to personal injury through damage to your superrollo GW180 / GW185 and the roller shutter system.

- ◆ Please check the superrollo GW180 / GW185 and all of your roller shutter components regularly for damage.
 - Regularly check the superrollo GW180 / GW185 for correct functioning.
 - The blinds must not be damaged.
 - The belt may not be frayed.
 - The deflection roller on the roller shutter box must move freely.
 - The reel plate in the roller shutter box must be fastened and stable. It may become less stable when used over a longer period of time.
- ◆ Damaged components should be exchanged by a specialist roller shutter firm.

Maintenance

You can clean the superrollo GW180 / GW185 using a damp cloth. Please do not use aggressive or abrasive cleaning agents.

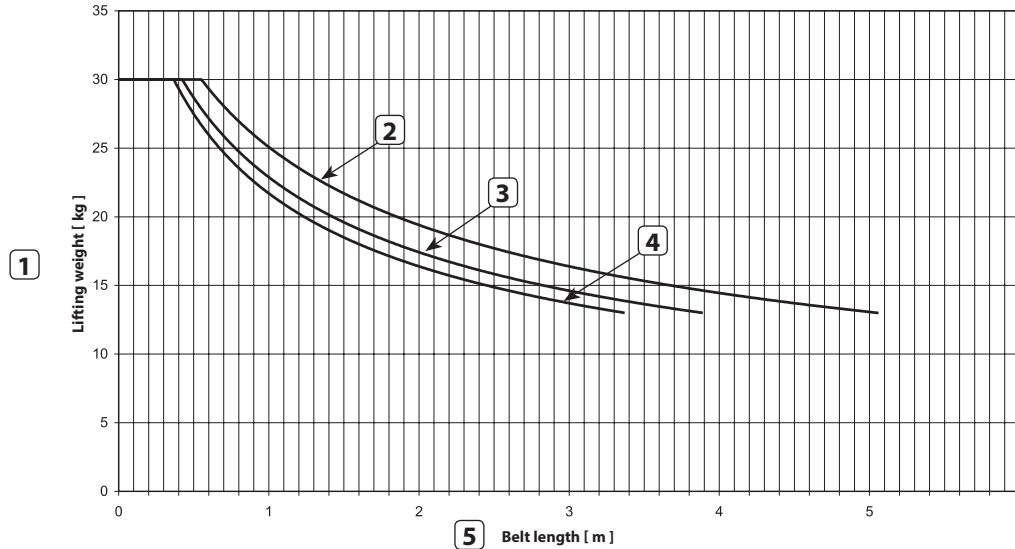

1 Lifting weight [Kg]

2 Belt thickness 1.0 mm

3 Belt thickness 1.3 mm

4 Belt thickness 1.5 mm

5 Belt length [m]

The electronic roller shutter belt winder **superrollo GW180 / GW185** (item No.: SR10180 / SR10185) complies with the requirements of the current European and national directives:



**2006/42/EC
Machinery Directive**
**2014/30/EU
EMC Directive**

The conformity has been verified and the corresponding declarations and documentation are available on file at the manufacturer's premises.

superrollo Hausautomatisierung GmbH

Gewerbepark 1

01156 Dresden (Germany)

superrollo Hausautomatisierung GmbH provides a 24-month warranty for new systems that have been installed in compliance with the installation instructions. All construction faults, material defects and manufacturing defects shall be covered by the warranty.

Your statutory warranty claims shall remain unaffected by this warranty.

The following shall not be covered by the warranty:

- ◆ Incorrect fitting or installation
- ◆ Non-observance of the installation and operating instructions
- ◆ Improper operation or wear and tear
- ◆ External influences, such as impacts, knocks or weathering
- ◆ Repairs and modifications by third parties, unauthorised persons
- ◆ Use of unsuitable accessories
- ◆ Damage caused by unacceptable excess voltages (e.g. lightning)
- ◆ Operational malfunctions caused by radio frequency overlapping and other such radio interference

A prerequisite for the warrant is that the new device must have been purchased from one of our approved specialist retailers. Proof of this must be provided by presenting a copy of the bill.

superrollo Hausautomatisierung GmbH will remedy any defects which occur within the warranty period free of charge either by repair or by replacement of the affected parts or by supply of a new replacement unit or one of the same value. There is no general extension of the original warranty period by delivery of a replacement or by repair as per the terms of the warranty.

superrollo Hausautomatisierung GmbH

Gewerbepark 1

01156 Dresden (Germany)

www.superrollo-online.de

Service Hotline: 01807 001-655*

* 30 seconds free of charge, subsequently 14 cents / minute from German fixed line networks and max. 42 cents / minute from German mobile networks.