



Electronic Roller Shutter Belt Winder superrollo GW190 / GW195

Translation of the Original Operating and Assembly Manual



Item No.:

superrollo GW190 *	SR10190
superrollo GW195 **	SR10195

* for standard belts (23 mm)

** for large belt boxes



Dear Customer,

EN

With your purchase of a roller shutter belt winder **superrollo GW190 / GW195**, you have chosen a quality product manufactured by superrollo. Thank you for the trust you have placed in us.

I	Dear Customer,	2	10. Drawing in and fastening the belt	23
1.	These instructions.....	4	11. Mounting the superrollo GW190/GW195.....	25
1.1	Application of this manual	4	12. End point adjustment.....	26
2.	Hazard symbols	4	13. Manual operation.....	28
2.1	Levels of danger and signal words	5	14. Setting the summer/winter time.....	29
2.2	Symbols and depictions used	5	15. Automatic timer; brief description	30
2.3	Technical Term - Definition.....	6	15.1 Configuring an opening and closing time	30
3.	Included in delivery	7	15.2 Switching the automatic timer on / off.....	31
4.	Overview superrollo GW190/GW195	8	16. Erase all settings, software reset	32
4.1	Operating Buttons and Indicator Light.....	9	17. Removing the superrollo GW190/GW195	
5.	Functional description	10	(e.g. in the event of a move).....	33
5.1	Description of the safety functions.....	11	18. Removing the belt in the event of unit failure	35
6.	Technical Specifications	12	19. What to do if... ?	37
6.1	Dimensions	13	20. Information about maintenance and care of your	
6.2	Permissible roller shutter belts	14	equipment	39
7.	Safety instructions	15	21. Tractive force diagram.....	40
7.1	Intended use.....	16	22. CE Mark and EC Declaration of Conformity.....	41
7.2	Improper use	17	23. Warranty conditions	42
7.3	Required expert knowledge of the installer	17		
8.	Safety instructions for the installation.....	18		
8.1	You will require the following tools	18		
8.2	Preparation for installation.....	19		
9.	Safety instructions for the electrical connection .	21		
9.1	Connecting the connecting cable to the			
	superrollo GW190/GW195	21		

i 1. These instructions...

...describes how to install, connect the electrical system and operate your roller shutter belt winder superrollo GW190/GW195.

i 1.1 Application of this manual

- ◆ Before you begin, please read this manual through completely and follow all the safety instructions.
- ◆ This manual is a component of the product. Please store it in an easily accessible place.
- ◆ When passing the superrollo GW190/GW195 on to a third party, this manual must be passed on as well.
- ◆ Damage resulting from non-compliance with these instructions and safety instructions will void the guarantee. We shall assume no liability for any consequential damage.

i 2. Hazard symbols

The following hazard symbols are used in this instruction manual:



Danger of fatal electric shock



Danger area / dangerous situation

2.1 Levels of danger and signal words

DANGER!

This hazard will result in serious injury or death if not avoided.

WARNING!

This hazard may result in serious injury or death if not avoided.

CAUTION!

This hazard may result in minor or moderate injury if not avoided.

ATTENTION!

This hazard may lead to property damage.

2.2 Symbols and depictions used

Depiction	Description
1.	Steps to be taken
2.	
◆	Itemisation
(1) or a)	List



Please read the respective manual



further useful information

DIN EN 13659

"Shutters and external Venetian blinds - Performance requirements including safety."

- ◆ This standard determines the performance requirements that externally attached shutters and blinds must fulfil. It also contains significant hazards with regard to the design, transportation, installation, operation and maintenance of these shutters and blinds.

Blinds

- ◆ Roller shutters

Obstacle detection

- ◆ If the roller shutters hit an obstacle in the DOWN (▼) direction, the superrollo GW190/GW195 is switched off, see page 11.

Overload cut-off

- ◆ If the drive jams in the UP (▲) direction (for example, due to ice), the superrollo GW190/GW195 is switched off, see page 11.

End points

- ◆ An end point is defined and set for each running direction of the roller shutter. Once this point has been reached, the superrollo GW190/GW195 switches off and the roller shutter stops.

Running Time Limit - Transient Operation (KB)

- ◆ The roller shutter belt winder superrollo GW190/GW195 is not designed for continuous operation. Transient operation defined the maximum permissible running time, see page 12 /15.

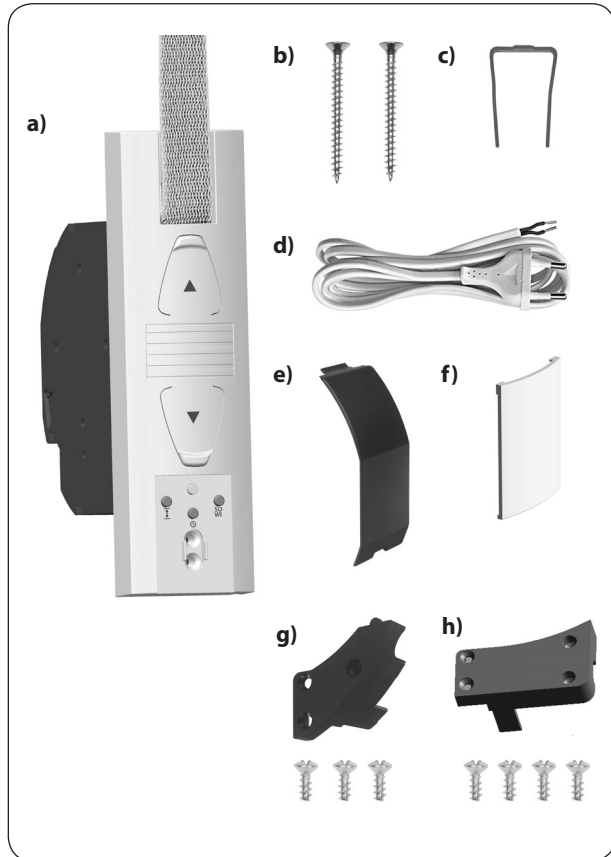

Included in delivery

- a) 1 x superrollo GW190 or
1 x superrollo GW195
- b) 2 x Assembly screws (4 x 55 mm)
- c) 1 x Disengaging bracket (in housing)
- d) 1 x Connecting cable with Euro plug
- e) 1 x Reel compartment cover
- f) 1 x Cover plate
- g) 1 x Traction relief mechanism incl. assembly screws
for superrollo GW190
- h) 1 x Traction relief mechanism incl. assembly screws
for superrollo GW195
- i) 1 x Instruction manual (not illustrated)

After unpacking please check and compare...

the contents of the package with the above specified.

Check the details on the type plate

Check that the voltage / frequency on the type plate corresponds to the local mains conditions.

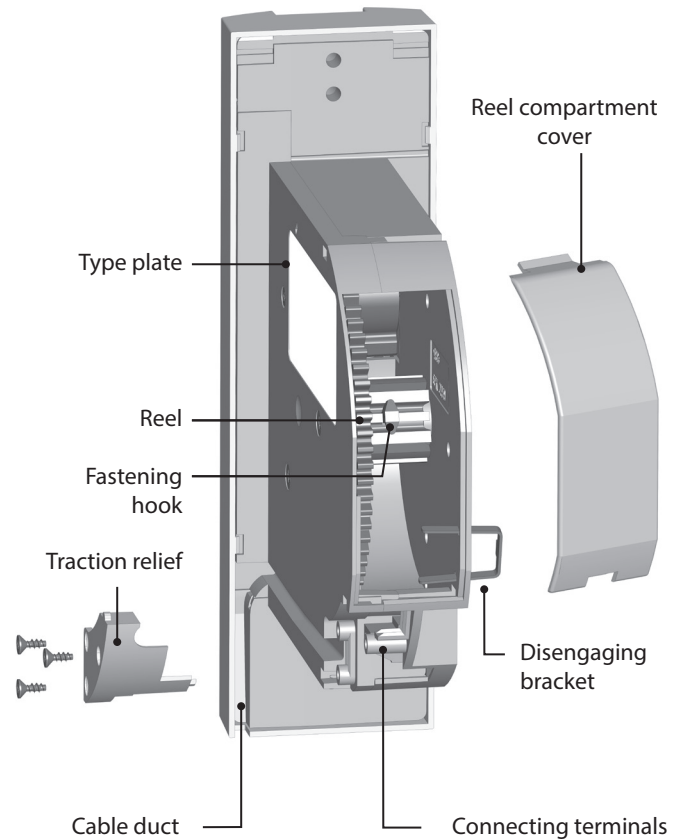
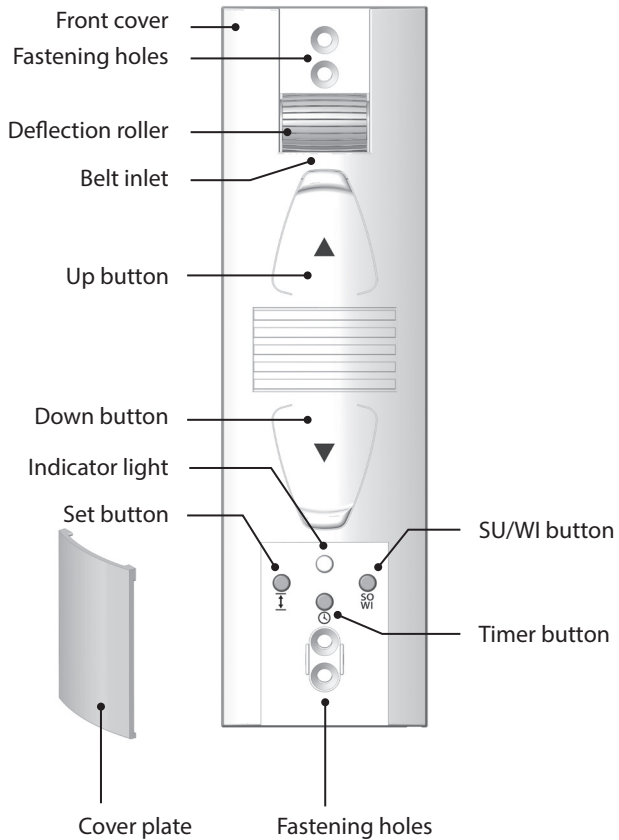

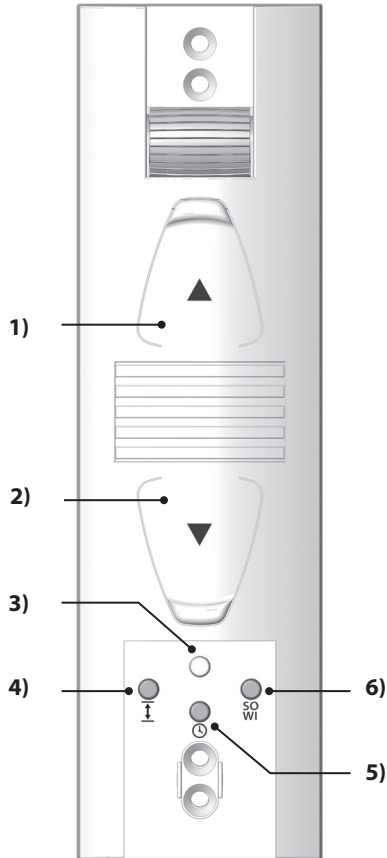

Pos.	Symbol	Description
1)		Up / Stop button <i>The roller shutter travels upwards.</i>
2)		Down / Stop button <i>The roller shutter travels downwards.</i>
3)		Indicator Light - Status Display
	red	<i>flashes briefly</i> <i>Return signal when pressing the timer button or the SU/WI button.</i>
		<i>continuous light</i> <i>Status display of the respective function (10 seconds)</i>
		<i>flashes briefly</i> ◆ <i>During the setting process or when resetting.</i>
		◆ <i>After a power failure</i>
4)		Set button <i>Setting the end points</i>
5)		Timer button ◆ <i>Setting both switching times</i> ◆ <i>Switching the automatic timer function on/off.</i>
6)		SU/WI button <i>Switching between summer and winter time.</i>

The superrollo GW190/GW195 is an electric roller shutter belt winder designed for use inside. The unit is installed as a flush-mounted device. The power supply is provided via the enclosed connecting cable with a mains plug or, if required, a fixed installed lead.

Features and control options:

- ◆ Manual operation
- ◆ Automatic mode, with a separate switching time for UP (▲) and DOWN (▼)
- ◆ Switching automatic mode on/off
- ◆ Summer/winter time - changeover
- ◆ End point setting
- ◆ Permanent storage of the settings
- ◆ Obstacle detection
- ◆ Overload cut-off
- ◆ Resetting to the default factory settings (Reset)

Obstacle detection

The movement of the belt is monitored. If the roller shutters hit an obstacle in the DOWN (▼) direction, the belt will stop moving and the superrollo GW190/GW195 is switched off.



Once the system has switched off, it is not possible to directly operate the drive in the same direction.

- ◆ First, run the belt winder back in the opposite direction and remove any possible obstacle.
- ◆ Then it is possible to operate the drive in the original direction again.



There is a risk of injury if the obstacle detection is not working.

- ◆ The belt must be wound on as evenly as possible to ensure safe and correct functioning of the obstacle detection function.
- ◆ Please ensure that the belt winds as straight and evenly as possible into the device during its subsequent cycle after the obstacle detection system has triggered.

Overload cut-off

The superrollo GW190 / GW195 is equipped with an overload cut-off system.

If the drive jams in the UP (▲) direction (for example, due to ice), the superrollo GW190 / GW195 is switched off.

- ◆ First remove the cause of the overload.
- ◆ Then the superrollo GW190 / GW195 is fully operational again in both directions.

Power supply

Supply voltage:	230 V ~ / 50 Hz
Nominal power:	70 W
Consumption:	Standby: < 0.5 W

Mechanical capacity

Nominal torque:	
- superrollo GW 190	10 Nm
- superrollo GW 195	14 Nm
Maximum speed:	
- superrollo GW 190	30 rpm
- superrollo GW 195	24 rpm
Maximum tractive force:	See page 40 / Tractive force diagram

Operating conditions

Transient operation (KB):	4 minutes (maximum running time)
Protection class:	II
Protection type:	IP20 (only for use in dry rooms)

Operating conditions

Number of switching times:	2 (up and down)
Mains connecting cable:	2 x 0.75 mm ² (H03VVH2-F)
Permissible ambient temperature:	0 °C to +40°C
Sound pressure level (LpA):	≤ 70 dB(A)

Conduct in the event of power failure

The indicator light flashes in the event of a power failure. The flashing is switched off by pressing the UP (▲) or DOWN (▼) button.

Data retention following a power failure

The configured switching times are retained after a power failure. As soon as the power supply is restored, the opening and closing times will be executed again. However, the times will be offset by the duration of the power failure.

Example:

- ◆ Power failure from 19:30 - 19:45 hours.
- ◆ The closing time was previously set to 19:30 hours.
- ◆ The roller shutters will close at 19:45 hours due to the duration of the power failure.



6.1 Dimensions

EN

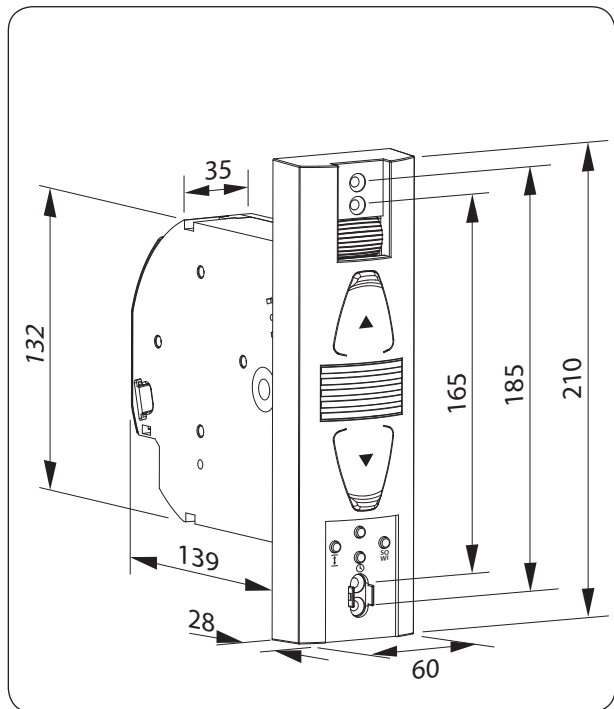

All dimensions in mm

superrollo GW190
Item no.: SR10190

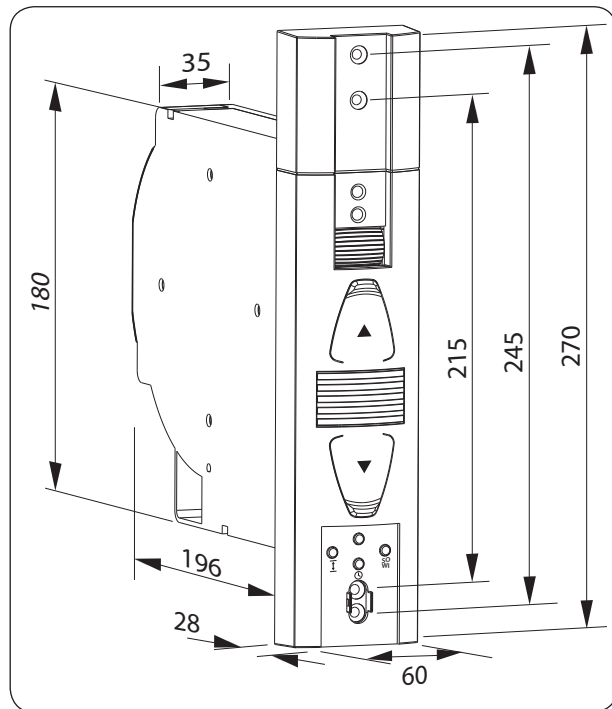

All dimensions in mm

superrollo GW195
Item no.: SR10195

⚠ ATTENTION!

The superrollo GW190/GW195 may be damaged if excessively long belts are used.

Only use belts of the permissible lengths.



The specifications are intended for guidance only and apply to an ideal installation situation.

The actual values may vary due to local conditions.

Table 1: Permissible roller shutter belts

superrollo: Item No.:		GW190 SR10190	GW195 SR10195
Belt width:	Belt thick- ness	Maximum belt length	
23 mm (Standard belt)	1.0 mm	7.6 m	15 m
	1.3 mm	6.2 m	12 m
	1.5 mm	5.2 m	11 m

Table 2: Permissible shutter surface area (m²)

Roller shutter type:	Weight/m²	Permissible shutter surface area (m²)	
Plastic roller shutters	(4.5 kg/m ²)	Approx. 6 m ²	Approx. 10 m ²
Aluminium and wooden roller shutters	(10.0 kg/m ²)	Approx. 3 m ²	Approx. 6 m ²



The use of defective equipment can lead to personal injury and damage to property (electric shocks, short circuiting).

- ◆ Never use defective or damaged equipment.
- ◆ Check the superrollo GW190/GW195 and the provided mains cable beforehand for damage.
- ◆ Should you discover damage to the equipment, please consult our customer service department (see page 44).



Incorrect use leads to an increased risk of injury.

- ◆ Train all personnel to use the superrollo GW190/GW195 safely.
- ◆ This device may be used by children from 8 years of age upwards as well as by persons with reduced physical, sensory or mental capacities or with lack of experience and knowledge if they are supervised or have been instructed on how to use the device safely and if they understand what dangers may resulted from this.
- ◆ Children must not play with the device. Cleaning and user maintenance may not be carried out by children without supervision.

- ◆ Watch the moving roller shutters whilst carrying out the settings and during normal operation, and keep other people away from the area to avoid injury in the event the shutters suddenly slip.
- ◆ Carry out all cleaning work on the roller shutters whilst the device is disconnected from the mains power.

The mains socket and plug must be easily accessible at all times.



Exceeding the maximum permissible running time (KB) may overload and damage the superrollo GW190/GW195.

- ◆ The maximum permissible running time for a cycle may not be exceeded when the equipment is in operation. For this reason, the superrollo GW190/GW195 has an **automatic running time limit (KB)** of four minutes.
- ◆ If the running time limit is triggered, then the superrollo GW190/GW195 must be left for at least 12 minutes to cool down.



During the cooling period the superrollo GW190 / GW195 may not be used and the indicator light flashes rapidly.

- ◆ Full operational availability is re-established after approx. one hour.

According to DIN EN 13659, it is necessary to determine that the movement conditions for the shutters are maintained in accordance with EN 12045.

- ◆ The displacement must be of at least 40 mm on the lower edge in the rolled-out position with a force of 150 N in the upwards direction.
- ◆ In doing so, it must be ensured that the extending speed of the shutters for the final 0.4 m is less than 0.15 m/s.

7.1 Intended use

Only use the superrollo GW190 / GW195 for opening and closing roller shutters with a permissible belt.



Mechanical locks of any kind are not suitable for automated operation with this device.

Only use the manufacturer's original spare parts.

- ◆ By doing so, you avoid risk of malfunctions and damage to your superrollo GW190 / GW195.
- ◆ As the manufacturer, we provide no guarantee for the use of third-party components and accept no liability for consequential damage resulting from such.
- ◆ All repairs to the superrollo GW190 / GW195 must be undertaken by authorised customer service personnel.

i 7.1 Intended use

Operating conditions

- ◆ Only operate the superrollo GW190/GW195 in dry rooms.
- ◆ A 230 V / 50 Hz power supply, together with a site-provided isolating device (fuse, MCB), must be permanently available at the installation location.

- ◆ An easily accessible 230 V / 50 Hz socket must be available at the installation site if the enclosed connecting cable with Euro plug is being used.
- ◆ The roller shutters must run up and down smoothly and should not stick.
- ◆ The mounting surface for the superrollo GW190/GW195 must be flat.

i 7.2 Improper use

Using the superrollo GW190/GW195 for purposes other than previously mentioned is impermissible.



There is a risk to life caused through short circuiting and electric shocks if the superrollo GW190 / GW195 is used outside.

- ◆ Never install or operate the superrollo GW190/GW195 outside.

i 7.3 Required expert knowledge of the installer

The electrical connection, installation and commissioning of the superrollo GW190/GW195 must only be carried out by a qualified electrician in accordance with the instructions in this manual.

i 8. Safety instructions for the installation



Poor routing of the belt can cause the belt to fail and leads to unnecessary loads on the superrollo GW190/GW195.

- ◆ Install the belt winder so that the belt runs as straight as possible into the device, in order to avoid unnecessary friction and wear.



Incorrect installation can lead to property damage.

- ◆ Strong forces are exerted during operation of the system which require secure installation on a firm base.

i 8.1 You will require the following tools

- ◆ Screwdriver
- ◆ Scissors
- ◆ Carpenter's gauge or measuring tape
- ◆ Pen

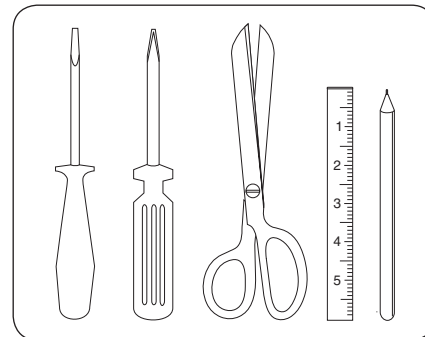

1. Take measurements. Check that the belt box has sufficient space to house the superrollo GW190/GW195.
 2. Remove the old belt winder, if you are carrying out a conversion to an existing roller shutter system.
- 2.1** Let the roller shutter move fully down, until the slats are completely closed.
- 2.2** Remove the old belt winder and unreel the belt.

⚠ CAUTION!

There is a risk of injury from the pre-tensioned springs on the old belt winder.

- ◆ The spring unit of the old belt winder may suddenly recoil when it is removed.
- ◆ Hold the spring unit firmly when loosening the belt and allow it to recoil slowly until the spring unit has completely unwound.

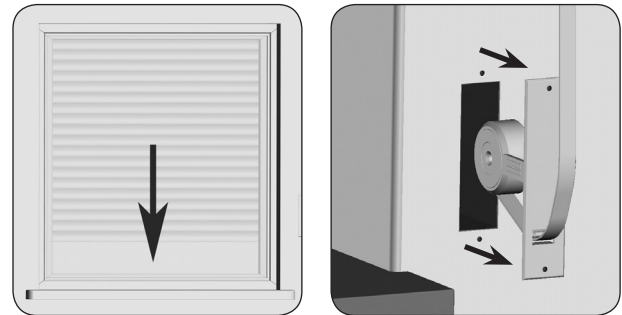

3. Prepare the belt.

3.1 Cut the belt off approx. 20 cm under the belt box.

3.2 Fold the end of the belt over by approx. 2 cm and cut a short slit in the centre. This enables you to subsequently hook the belt onto the reel.

Recommendation

The belt must run as straight and freely as possible. For stiff roller shutters, mount a deflection roller on the belt box. This helps to prevent unnecessary friction and wear to the belt.

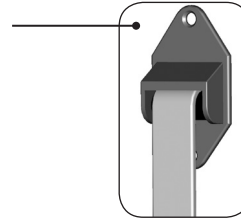
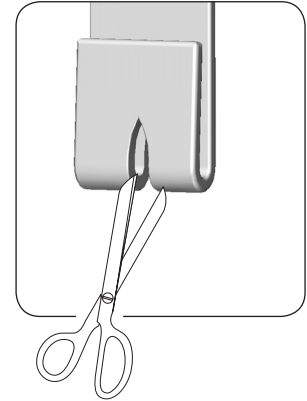
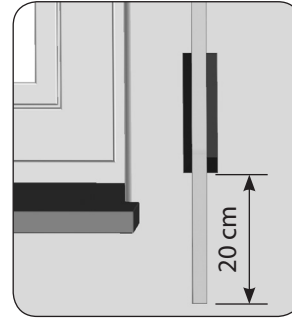

⚠ DANGER!

There is a risk of fatal electric shock when touching electrical components.

- ◆ Carry out all installation and connection work in an isolated and de-energised state.
- ◆ Disconnect all phases of the mains power supply cable and secure it to prevent any reconnection.
- ◆ Check that the system is de-energised.



The electrical connection can be made either with the supplied connecting cable or via a fixed laid cable on site.

9.1 Connecting the connecting cable to the superrollo GW190 / GW195

1. Connect the provided connecting cable to the connecting terminals of the superrollo GW190 / GW195. The colour coding is irrelevant for this connection.

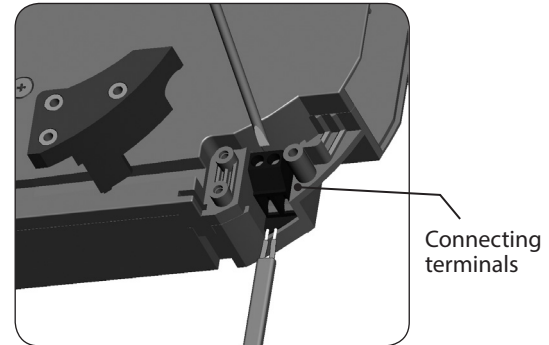

superrollo GW190

⚠ WARNING!

A damaged connecting cable may cause a short circuit.

- ◆ Ensure that the connecting cable is laid safely.
- ◆ The connecting cable must not be pinched or damaged when screwing on the superrollo GW190/GW195.

2. Lay the connecting cable in the cable duct of the superrollo GW190/GW195.
3. Finally, screw on the traction relief mechanism with the screws provided.

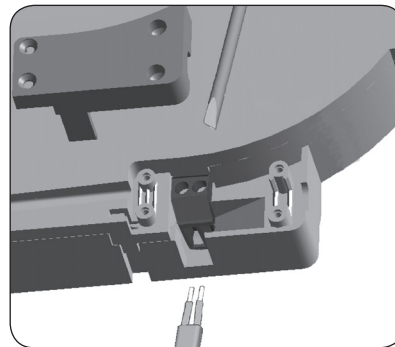

superrollo GW195

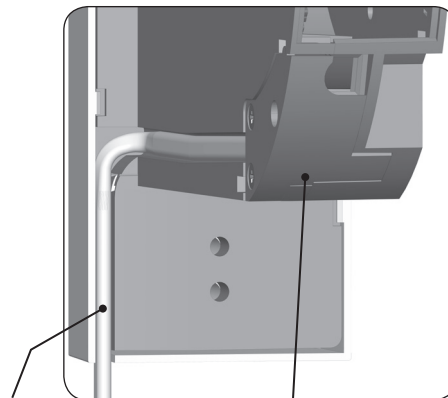

Cable duct

Traction relief

i 10. Drawing in and fastening the belt

1. Insert the mains plug into the socket.

⚠ CAUTION!

There is a risk of injury from the reel.

Never reach into the reel compartment when the motor is running.

2.  Press the Up button until the fastening hook are easily accessible in the reel compartment.



As no end points have been set yet, the drive will stop as soon as you release the button.

3. Remove the mains plug again from the socket.

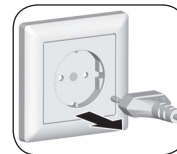
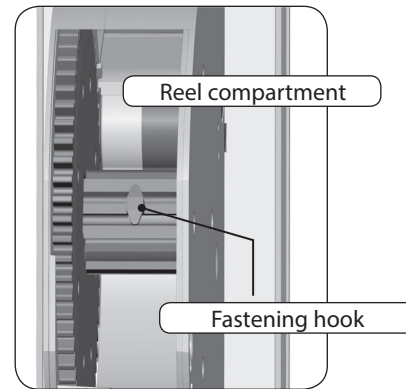

4. Next, draw-in the belt into the superrollo GW190/GW195 from the top.
Feed the belt into the device, as shown in the image, and slide it over the fastening hook from above.
5. Re-insert the mains plug into the socket.
6.  Press the up button until the belt has fully wound once around the reel.
7. Pull the belt tight when winding, so that the deflection roller turns at the same time.
8. Remove the mains plug again from the socket.
9. Finally, place the provided reel compartment cover onto the reel compartment.

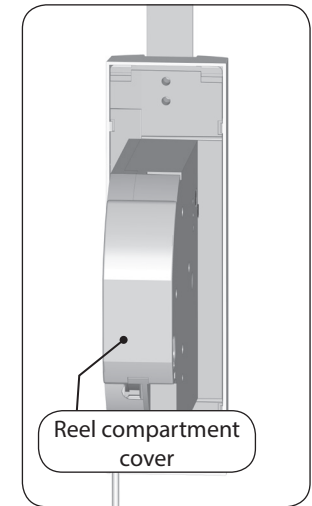
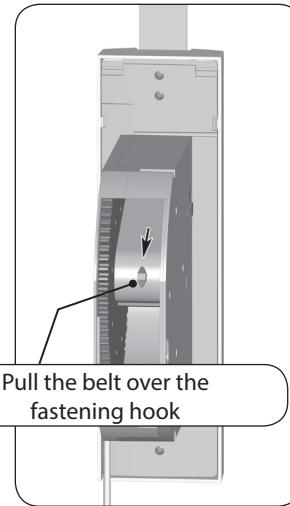
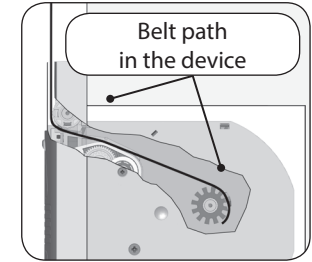
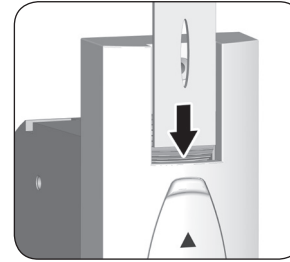

11. Mounting the superrollo GW190 / GW195

Mount the superrollo GW190 / GW195 as straight as possible, so that the belt can wind correctly.
Ensure that the superrollo GW190 / GW195 sits freely in the belt box and that it isn't in contact with the masonry, otherwise noise will be generated during operation.

1. Slide the superrollo GW190 / GW195 into the belt box and screw it tight using the screws provided.

⚠ WARNING!

A damaged connecting cable may cause a short circuit.

Ensure that the connecting cable is laid correctly inside the cable duct, otherwise it can be crushed and damaged when the cover is screwed in place.

2. Re-insert the mains plug into the 230 V / 50 Hz socket.



Leave the bottom cover plate open until all settings have been carried out.

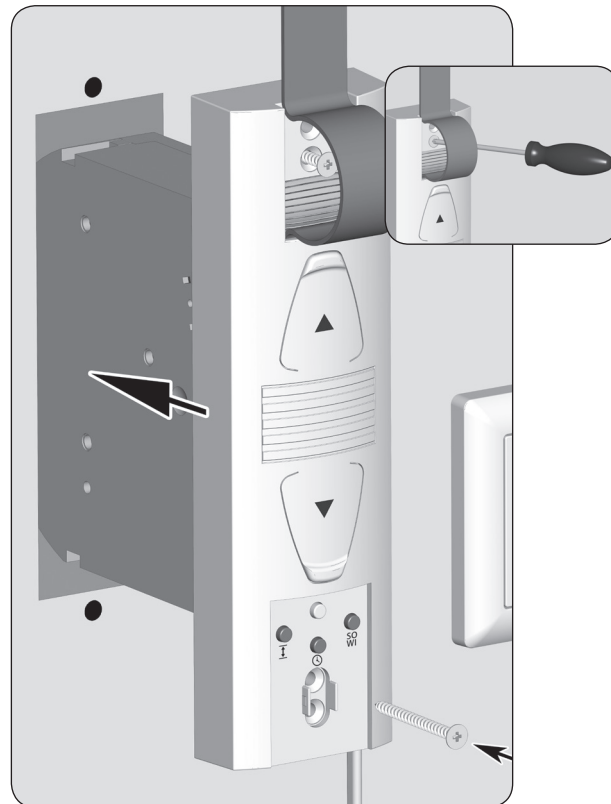



12. End point adjustment

EN

Additional information about configuring the end points

The end points must be configured for the roller shutters to stop at the desired upper and lower positions.



It is imperative that both end points are configured, otherwise malfunctions may occur.





If the superrollo GW190/GW195 is operated without an end point setting, the drive will continue to run as long as one of the two control buttons is actuated.

The automatic functions remain blocked until the end point setting is configured.

Set the upper end point

1.  +  Simultaneously press and hold the buttons.
The roller shutter travels up.

- 1.1 Tighten the belt slightly, until it is tensioned by the weight of the roller shutters.

2.  +  Release the buttons, as soon as the roller shutter reaches the desired position for the upper end point.
The roller shutters stop and the upper end point is stored.

ATTENTION!

Setting the wrong upper end point may lead to overload or damage the superrollo GW190/GW195 or the drive.



- ◆ Do not set the upper end point right up to the limit stop.
- ◆ Release the button promptly and never allow it to extend beyond the respective end point.





12. End point adjustment

EN

Set the lower end point

3.  +  Simultaneously press and hold the buttons.
The roller shutter travels down.

4.  +  Release the buttons, as soon as the roller shutter reaches the desired position for the lower end point.
The roller shutters stop and the lower end point is stored.



Please ensure that the belt is not excessively slack when reaching the lower end point.

Changing or correcting the end points

5. Move the roller shutters to the centre position and configure the respective end point again.







After a period of time it may be necessary to reconfigure the end points as the belt may elongate during the process of operation.



13. Manual operation

Manual operation is possible in any of the modes and has priority over the programmed automatic functions.

1.  Open the roller shutters.
By briefly pressing the button, the roller shutters will move to the upper end point.
2.  or  Stop the shutters in the interim.
3.  Close the roller shutters.
By briefly pressing the button, the roller shutters will move to the lower end point.

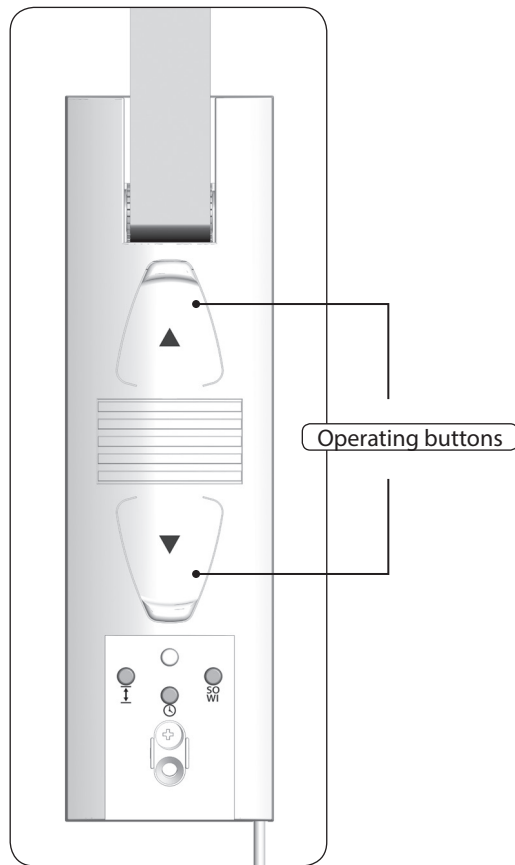



14. Setting the summer/winter time

The superollo GW190/GW195 is equipped with a summer/winter changeover function. With this, the internal timer of the belt can be set to the summer or winter time.

Call up the current time status

1.  Briefly press the SU/WI button.
2. Pay attention to the indicator light.
The indicator light flashes briefly to confirm that the SU/WI button has been pressed. The status of the summer/winter setting will then be displayed.

-  ON (10 seconds) = summer time
-  OFF = winter time



The superollo GW190/GW195 is delivered from the factory with the summer time.

Setting the summer/winter time

1.  Press the SU/WI button for approx. 1 second.
2. The respective current time status will be changed over.



15. Automatic timer; brief description

The same switching times every day of the week.

You can set an opening and closing time for your superrollo GW190/GW195 which will apply to all days of the week. Once this time is reached, the roller shutters will open or close automatically.

Changing the switching times

You can change the switching time settings at any time. Please note that each new setting deletes the previous setting.



In order to set the switching times, you must carry out this step once at the time that the roller shutters are to open or close.

For example, carry out the step at 8:00 o'clock in the morning if you want the roller shutters to open at 8:00 AM every day.

- ◆ You must set at least one switching time, in order to activate the automatic timer.



15.1 Configuring an opening and closing time

Configure an opening time (▲) (e.g. at 8:00 AM)

1. + Simultaneously briefly press the buttons.



2. The indicator light flashes and the roller shutter travels upwards. The automatic timer is now activated.

Your roller shutters will open automatically every day at 8:00 AM.



15.1 Configuring an opening and closing time



Configure a closing time (▼)
(e.g. at 20:30 hours)

1.  +  Simultaneously briefly press the buttons.
2.  The indicator light flashes and the roller shutter travels downwards. The automatic timer is now activated. Your roller shutters will close automatically every day at 20:30.



15.2 Switching the automatic timer on / off

If required, the automatic timer can be switched on or off at any time.

1.  Press and hold the timer button for approx. 1 second.
2. Pay attention to the indicator light.
The indicator light flashes briefly to confirm that the timer button has been pressed. The status of the automatic timer will then be displayed.
 -  OFF
Automatic timer OFF
The previously configured switching times are stored.



ON (10 seconds)
Automatic timer ON



Flashing
After power failure, if at least one switching time was previously been configured.







In the event of power failure, the switching times will be extended by the duration of the power failure, and therefore may require reconfiguration.

If necessary, you can erase all of your settings and return the superrollo GW190/GW195 system to its original factory settings.

1. Remove the cover plate from the lower assembly screws and setting buttons.









2.  +  +  Simultaneously press and hold the buttons for 4 seconds.
3.  The indicator light flashes rapidly.
4. Release the buttons, subsequently all of the settings will be deleted.
 - ◆ End points
 - ◆ Timer periods
5. The indicator light will go off once the button is released.



17. Removing the superrollo GW190 / GW195 (e.g. in the event of a move)

EN

1. Remove the cover plate from the lower assembly screws and setting buttons.
2.  +  +  Erase all settings.
Simultaneously press and hold the buttons for 4 seconds.
3.  Fully close the roller shutters.
4.  Continue to press and hold the down button.
5. In doing so, pull out the belt as far as possible from the top of the superrollo GW190 / GW195.
6.  Remove the mains plug from the
7. Subsequently release the fastening screws and pull the superrollo GW190 / GW195 completely out of the belt box.

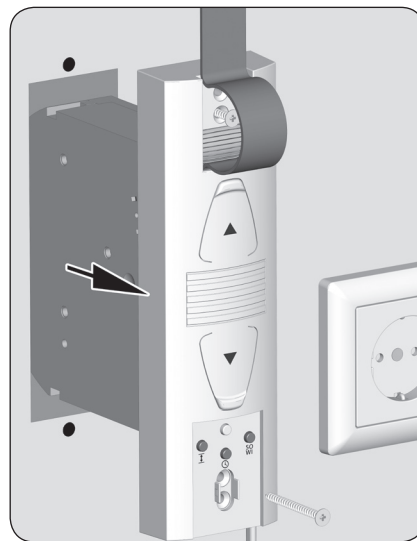
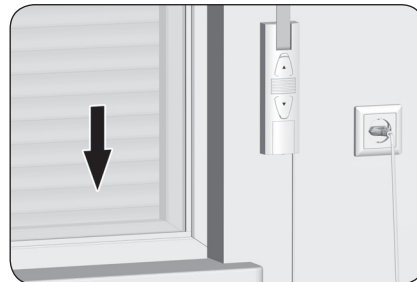

i 17. Removing the superrollo GW190 / GW195 (e.g. in the event of a move)

EN

8. Remove the reel compartment cover.
9. Check the position of the fastening hook.
10. If necessary, move the fastening hook into an easily accessible position.

⚠ CAUTION!

There is a risk of injury from the reel.

- ◆ Never reach into the reel compartment when the motor is running.
- ◆ Always remove the mains plug before touching the reel compartment.

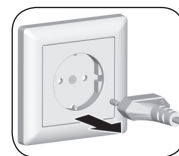
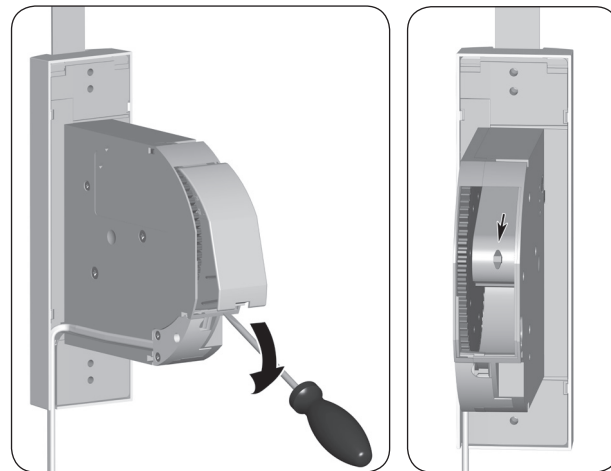

11. Finally, remove the mains plug again from the socket.
12. Release the belt from the fastening hook and pull it out completely from the front of the superrollo GW190 / GW195.

In the event that the superrollo GW190/GW195 unit fails and the motor no longer runs, you can use the disengaging bracket provided in order to fully remove the belt from the belt winder unit, without the need for cutting it.

1.

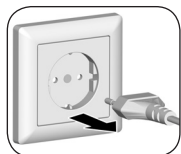

Remove the mains plug from the socket.

2.

Dismantle the superrollo GW190/GW195 as previously demonstrated on page 33.

WARNING!

There is a risk of injury as the roller shutters may slam shut or fall in an uncontrolled manner.

- ◆ Secure the roller shutters from falling.
- ◆ Hold on to the belt tightly to stop the roller shutters from slamming shut or falling in an uncontrolled manner.
- ◆ Get a second person to help you unlatch the unit.

3. Release the drive with the help of the supplied disengaging bracket. A small amount of resistance must be overcome when pressing.

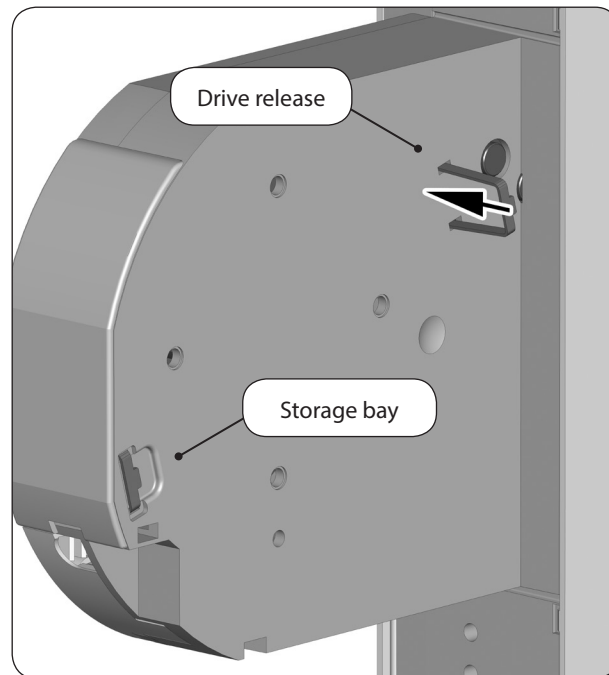

superrollo GW190

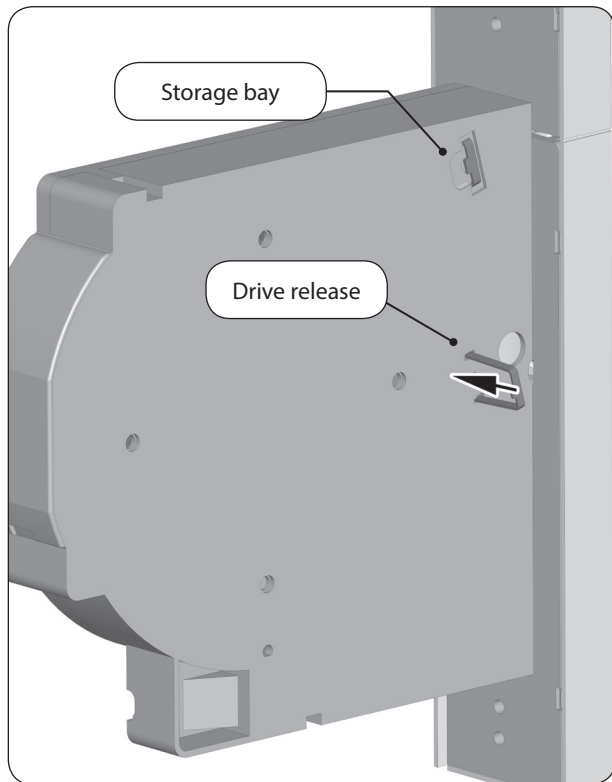

superrollo GW195

4. Maintain pressure on the disengaging bracket and pull the belt out of the superrollo GW190/GW195 as far as possible.
5. Release the belt from the fastening hook and pull it out completely from the superrollo GW190/GW195.
6. Place the disengaging bracket back into the storage compartment.

Fault	Possible cause / solution
... the superrollo GW190/GW195 indicates no functions?	Check the power supply incl. connecting cable and plug.
... the superrollo GW190/GW195 no longer reacts in the morning at the configured switching time?	a) There may have been a power failure. Reconfigure the switching times, see page 30.
	b) The end points may not be configured. Reconfigure the end points, see page 26.
... the indicator light (LED) is flashing?	There may have been a power failure. Reconfigure the switching times, see page 30.
... the roller shutters no longer stop at the configured end points?	The end points may be displaced due to elongation of the belt. Re-adjust the end points, see page 26.
... the roller shutters stop as soon as the operating button is released?	The end points are not configured. Configure the end points, see page 26.
... the superrollo GW190/GW195 rotates in the wrong direction?	Possibly the belt is wrapped around the reel incorrectly, see page 23.
... the roller shutters stop suddenly during upward travel?	a) The drive may be jammed, for example, due to the roller shutters freezing up or other obstacles.
	b) The roller shutters may not be running sufficiently smoothly. Check the roller shutters and roller shutter guides.
	d) The roller shutters may be too heavy. The maximum tractive force of the belt winder has been exceeded, see page 40.

Fault	Possible cause / solution
... the roller shutters stop during downward travel?	<p>a) The roller shutters may have hit an obstacle. Move the roller shutters back up and remove the obstacle.</p> <p>b) Slats have shifted out of alignment. If possible, move the roller shutters back up and realign the slats.</p> <p>c) The roller shutters scrape against the window frame or inside the roller shutter box due to the lack of a pinch roller or insulation material may have come free and is jamming the roller shutters. Open the roller shutter box and rectify the fault. Lubricate any stiff areas with gliding wax.</p> <p>d) The roller shutters are too light. Increase the weight of the roller shutters by, for example, adding a piece of flat steel to the bottom slat.</p>
... the indicator light flashes and the superrollo GW190/GW195 fails to operate in either direction?	<p>The maximum running time of the drive has been exceeded, see page 12/15.</p> <p>The motor is too hot. The belt winder will be fully operational again in approx. 1 hour.</p>
... the superrollo GW190/GW195 fails to react properly either manually or automatically?	<p>The superrollo GW190/GW195 is no longer ready for operation. Carry out a software reset in accordance with the instructions on page 32 and test the superrollo GW190/GW195 using the default factory settings.</p>

Maintenance

 **CAUTION!**

A lack of maintenance can lead to personal injury through damage to your superrollo GW190 / GW195 and the roller shutter system.

- ◆ Please check the superrollo GW190 / GW195 and all of your roller shutter components regularly for damage.
 - Regularly check the superrollo GW190 / GW195 for correct functioning.
 - The blinds must not be damaged.
 - The belt may not be frayed.
 - The deflection roller on the roller shutter box must move freely.
 - The reel plate in the roller shutter box must be fastened and stable. It may become less stable when used over a longer period of time.
- ◆ Damaged components should be exchanged by a specialist roller shutter firm.

Care

You can clean the superrollo GW190 / GW195 using a damp cloth. Please do not use aggressive or abrasive cleaning agents.

The electronic roller shutter belt winder **superrollo GW190 / GW195** (item No.: SR10190 / SR10195) complies with the requirements of the current European and national directives:



**2006/42/EC
Machinery Directive**
**2014/30/EU
EMC Directive**

The conformity has been verified and the corresponding declarations and documentation are available on file at the manufacturer's premises.

superrollo Hausautomatisierung GmbH
Gewerbepark 1
01156 Dresden (Germany)

superrollo Hausautomatisierung GmbH provides a 24-month warranty for new systems that have been installed in compliance with the installation instructions. All construction faults, material defects and manufacturing defects shall be covered by the warranty. Your statutory warranty claims shall remain unaffected by this warranty.

The following shall not be covered by the warranty:

- ◆ Incorrect fitting or installation
- ◆ Non-observance of the installation and operating instructions
- ◆ Improper operation or wear and tear
- ◆ External influences, such as impacts, knocks or weathering
- ◆ Repairs and modifications by third parties, unauthorised persons
- ◆ Use of unsuitable accessories
- ◆ Damage caused by unacceptable excess voltages (e.g. lightning)
- ◆ Operational malfunctions caused by radio frequency overlapping and other such radio interference

A prerequisite for the warrant is that the new device must have been purchased from one of our approved specialist retailers. Proof of this must be provided by presenting a copy of the bill.

superrollo Hausautomatisierung GmbH will remedy any defects which occur within the warranty period free of charge either by repair or by replacement of the affected parts or by supply of a new replacement unit or one of the same value. There is no general extension of the original warranty period by delivery of a replacement or by repair as per the terms of the warranty.

superrollo Hausautomatisierung GmbH

Gewerbepark 1

01156 Dresden (Germany)

www.superrollo-online.de

Service Hotline: 01807 001-655*

* 30 seconds free of charge, subsequently 14 cents / minute from German fixed line networks and max. 42 cents / minute from German mobile networks.